

GEN1500 SERIES EVALUATION DATA

DWG: IA575-53-01

 **NEMIC-LAMBDA LTD.**

INDEX

PAGE

1. EVALUATION METHOD

1-1. Circuits used for determination T-1~6

- (1) Steady state data
- (2) Warm up voltage drift characteristics
- (3) Over voltage protection (OVP) characteristics
- (4) Output rise characteristics
- (5) Output fall characteristics
- (6) Dynamic line response characteristics
- (7) Dynamic load response characteristics
- (8) Inrush current characteristics
- (9) Leakage current characteristics
- (10) Output ripple and noise waveform 6V to 100V models
- (11) Output ripple and noise waveform 600V model
- (12) Ripple RMS current

1-2. List of equipment used T-7

2. CHARACTERISTICS

2-1. Steady state data

- (1) Regulation-line and load, temp. drift T-8~11
- (2) Output voltage and ripple voltage v.s. input voltage T-12,13
- (3) Efficiency and input current v.s. input voltage T-14~17

2-2. Warm up voltage drift characteristics T-18~21

2-3. Over voltage protection (OVP) characteristics T- 22,23

2-4. Output rise characteristics T-24~31

2-5. Output fall characteristics T-32~39

2-6. Hold up time characteristic T-40,41

2-7. Dynamic line response characteristics T-42~49

2-8. Dynamic load response characteristics T-50~57

2-9. Response to brown out characteristics T-58~61

2-10. Inrush current characteristics T-62,63

2-11. Inrush current waveform T-64~69

2-12. Input current waveform T-70

2-13. Leakage current characteristics T-71,72

2-14. Output ripple & noise T-73~76

TERMINOLOGY USED

Definition

Vin	Input voltage
Vout	Output voltage
Iin	Input current
Iout	Output current
Ta	Ambient temperature

NEMIC-LAMBDA

1. EVALUATION METHOD

GEN1500

1-1. Circuits used for determination

(1) Steady state data

Constant Voltage Mode

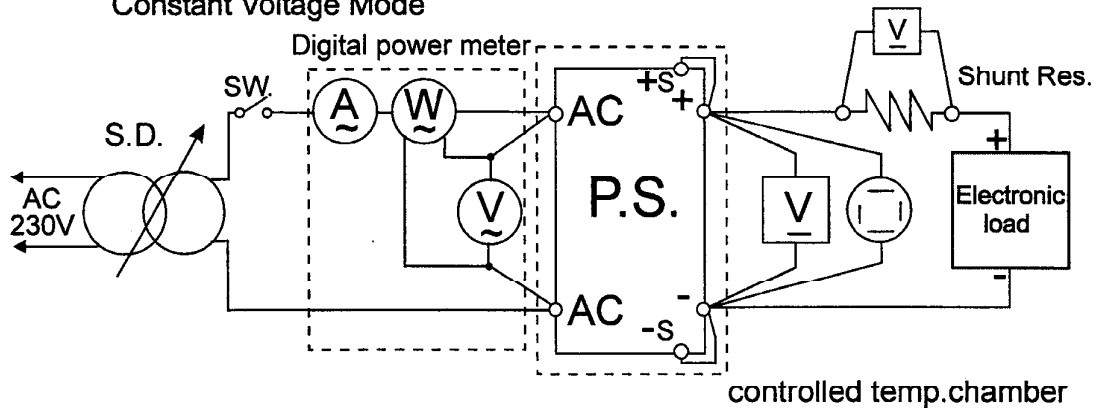

Constant Current Mode

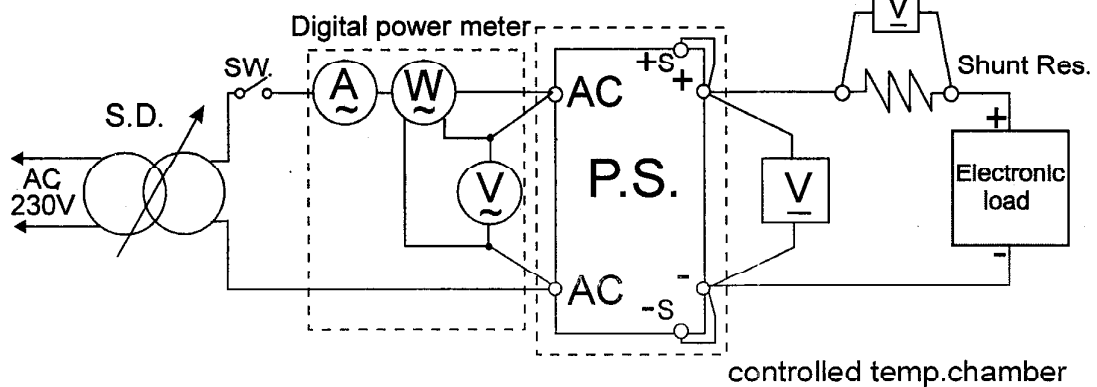

(2) Warm up voltage drift characteristics

Constant Voltage Mode

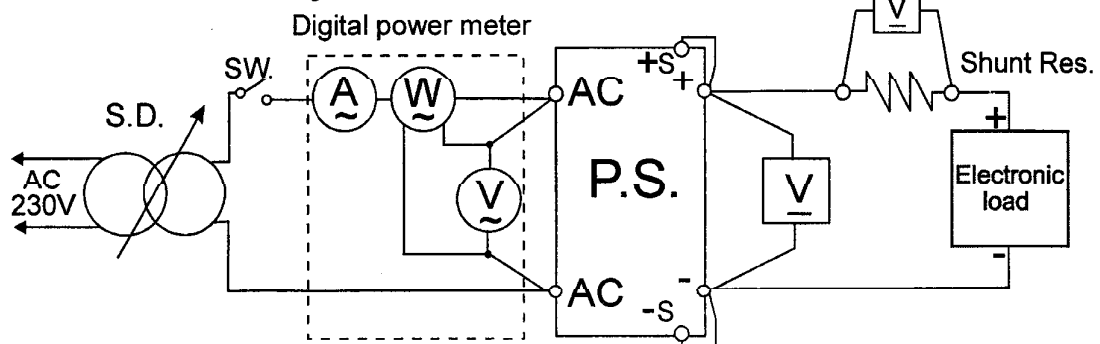

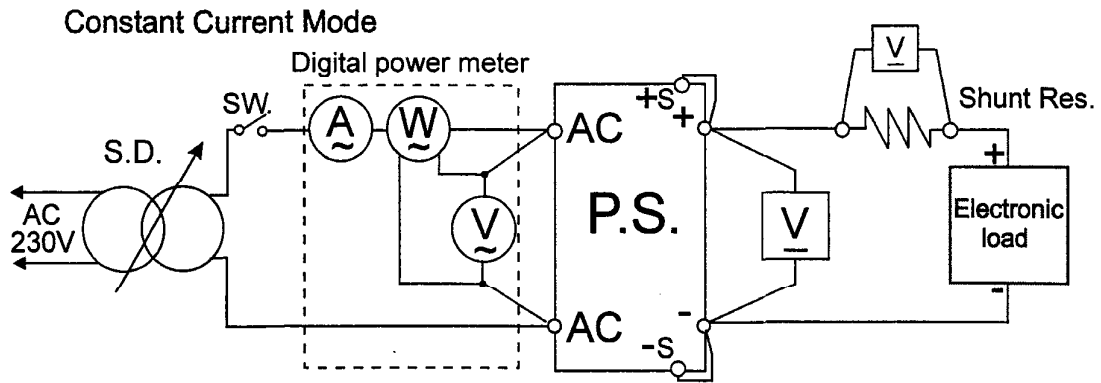

(3) Over voltage protection (OVP) characteristics
Constant Voltage Mode

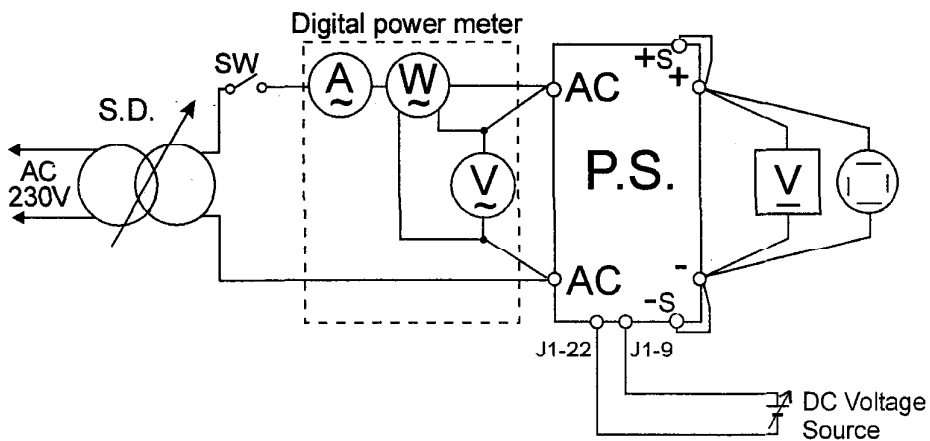

(4) Output rise characteristics
Constant Voltage Mode

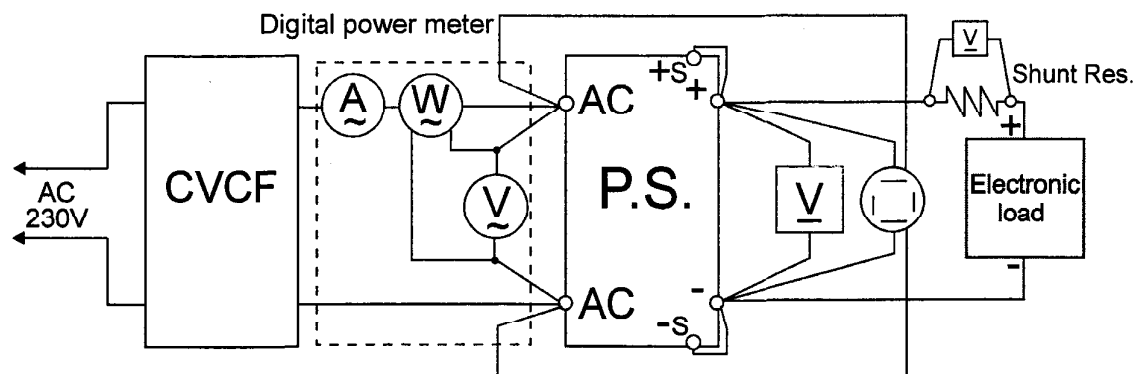

Constant Current Mode

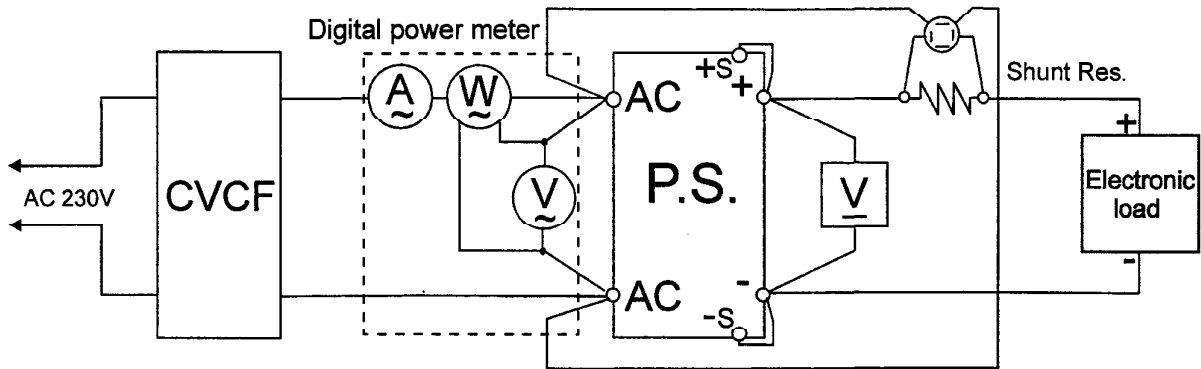

- (5) Output fall characteristics
Same as output rise characteristics

- (6) Dynamic line response characteristics
Constant Voltage Mode

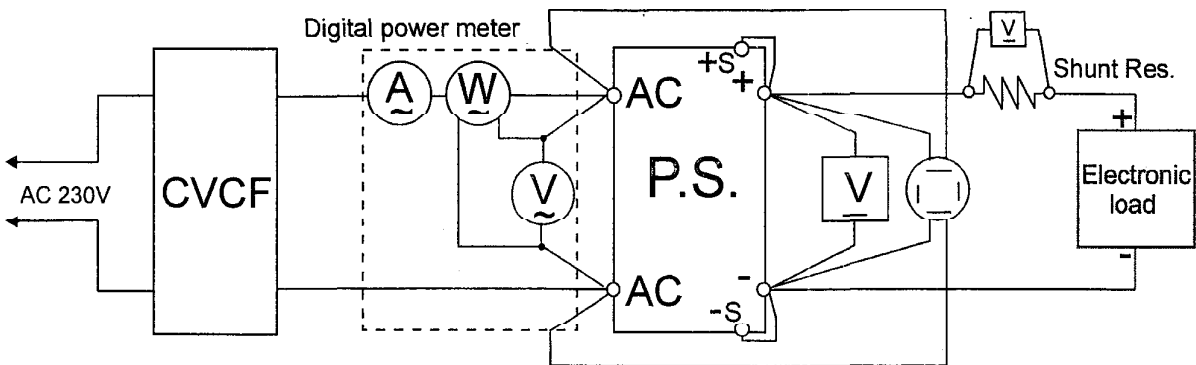

Constant Current Mode

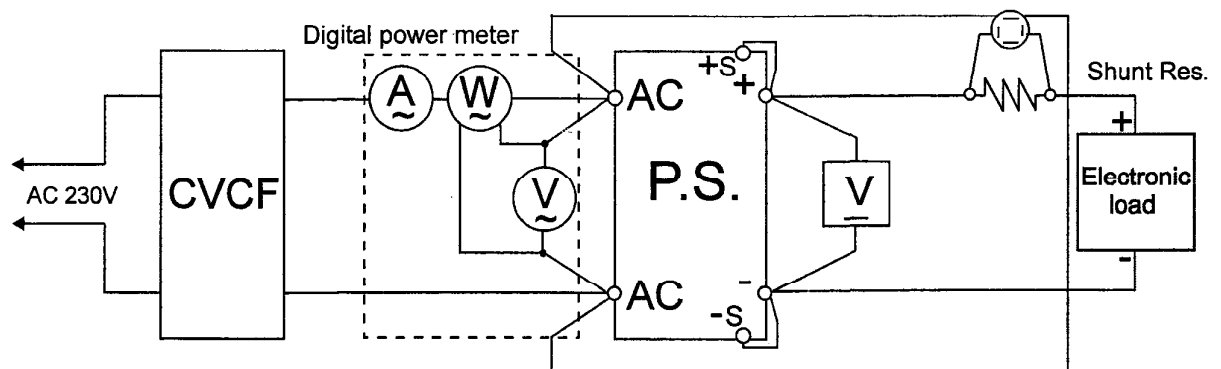

(7) Dynamic load response characteristics
Constant Voltage Mode

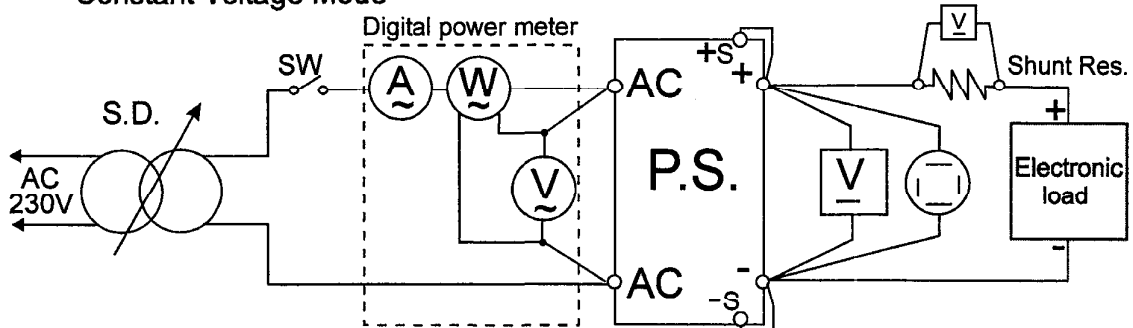

Output current waveform
I_{out} 0% ↔ 100%

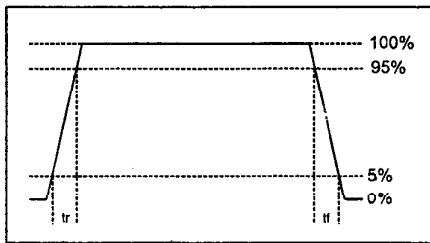

Output current waveform
I_{out} 50% ↔ 100%

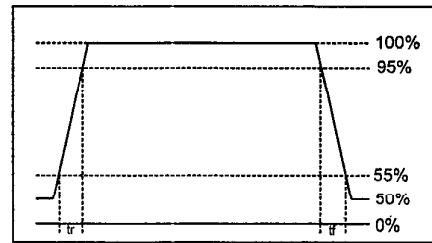

(8) Inrush current characteristics
Constant Voltage Mode

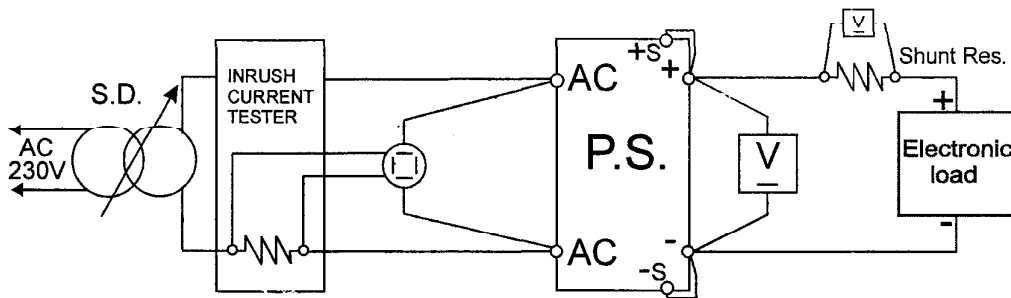

(9) Leakage current characteristics

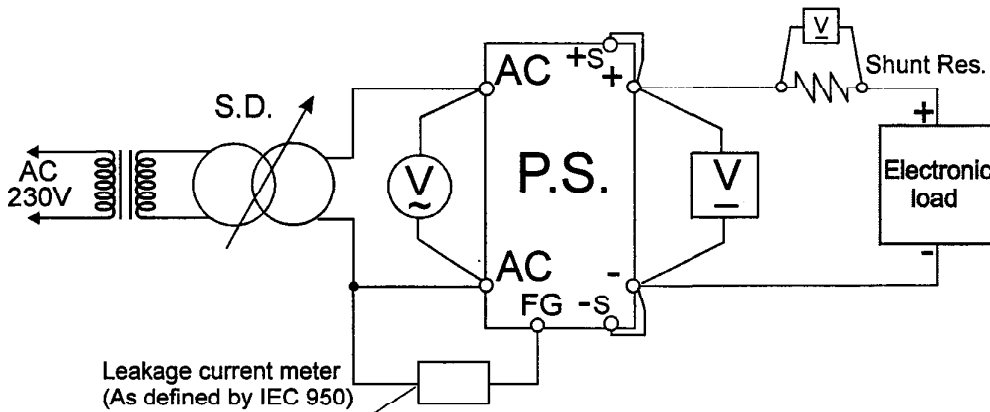

(10) Output ripple & noise waveform 6V to 100V models
Constant Voltage Mode

(a) NORMAL MODE

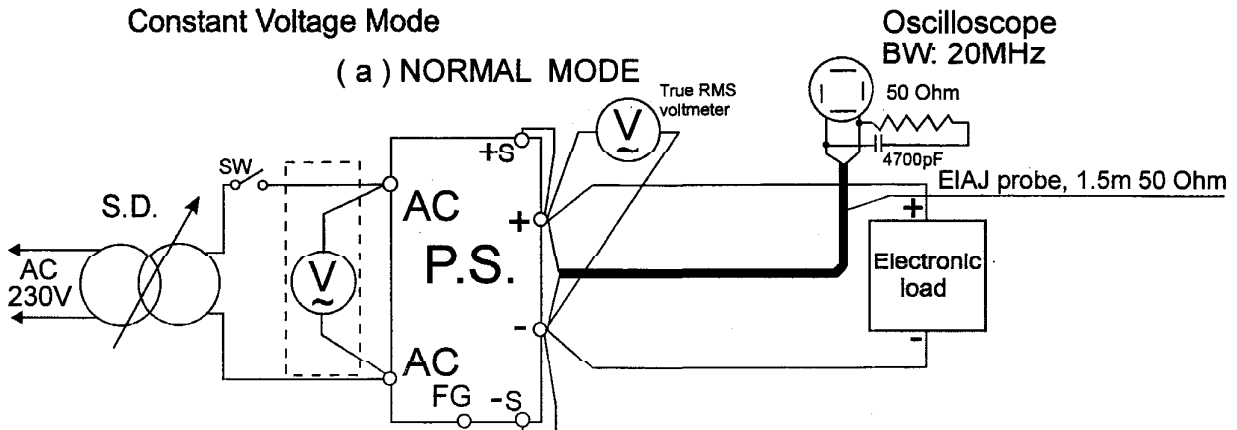

(b) NORMAL + COMMON MODE

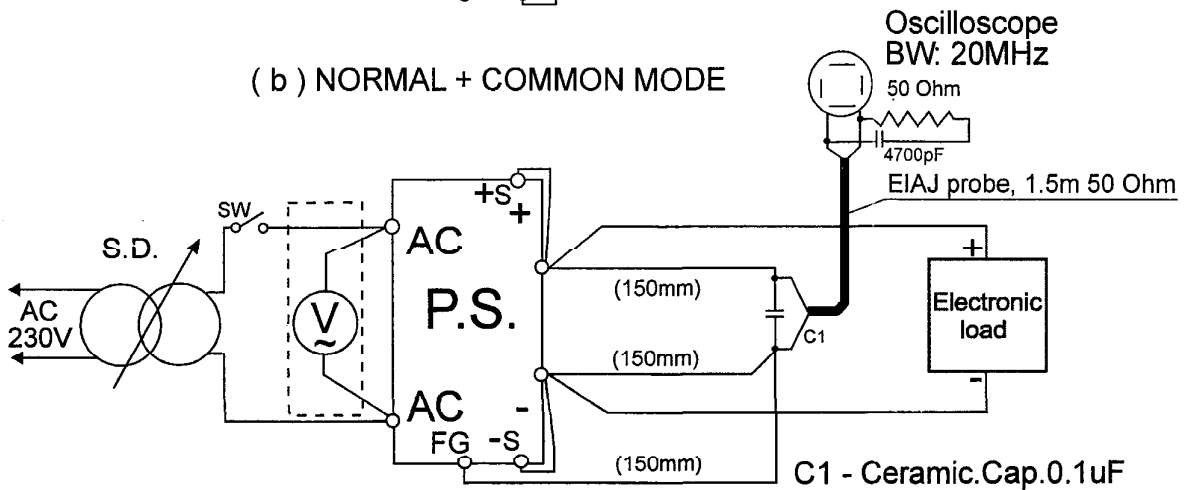

(11) Output ripple & noise waveform 600V model
Constant Voltage Mode

(a) NORMAL MODE

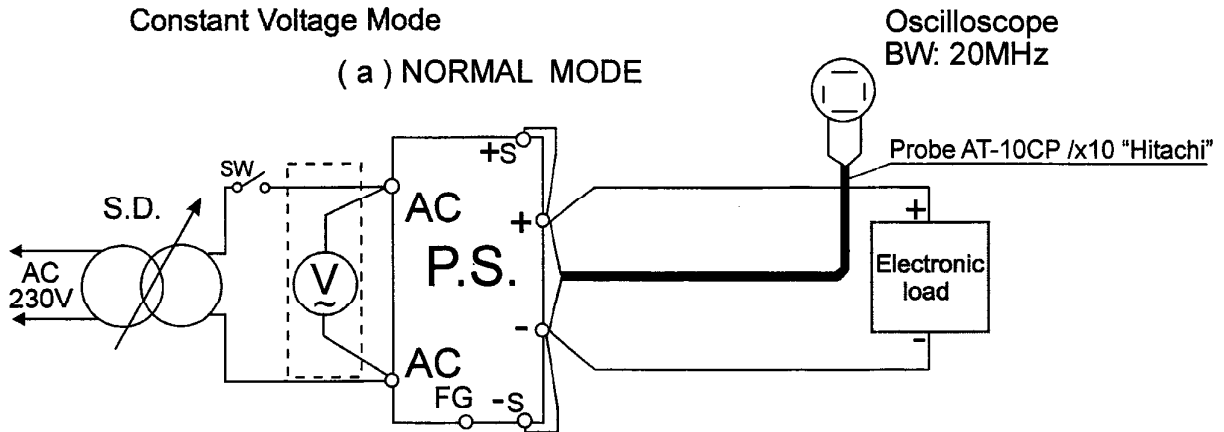

(b) NORMAL + COMMON MODE

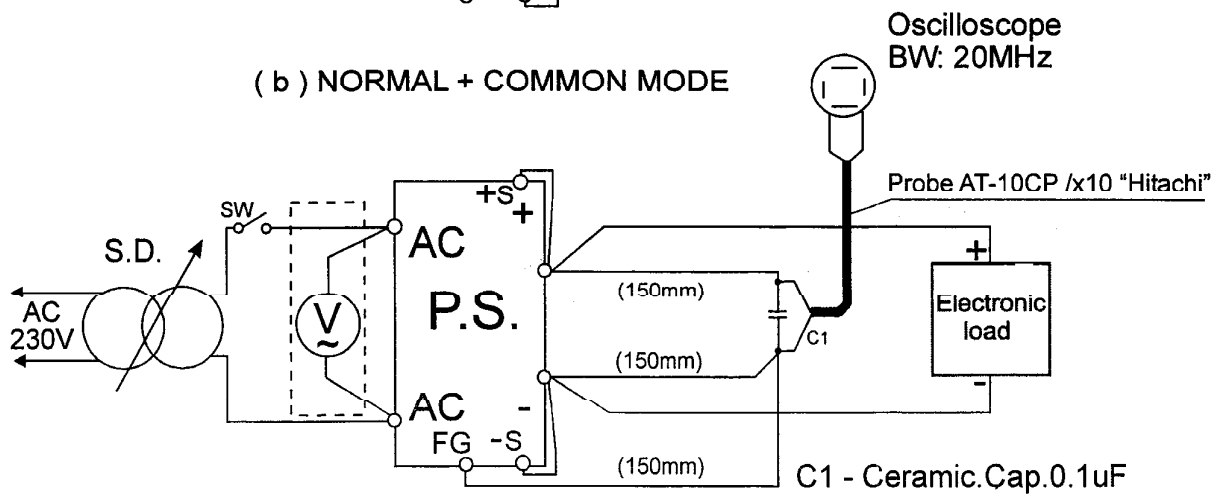

(12) Ripple RMS Current

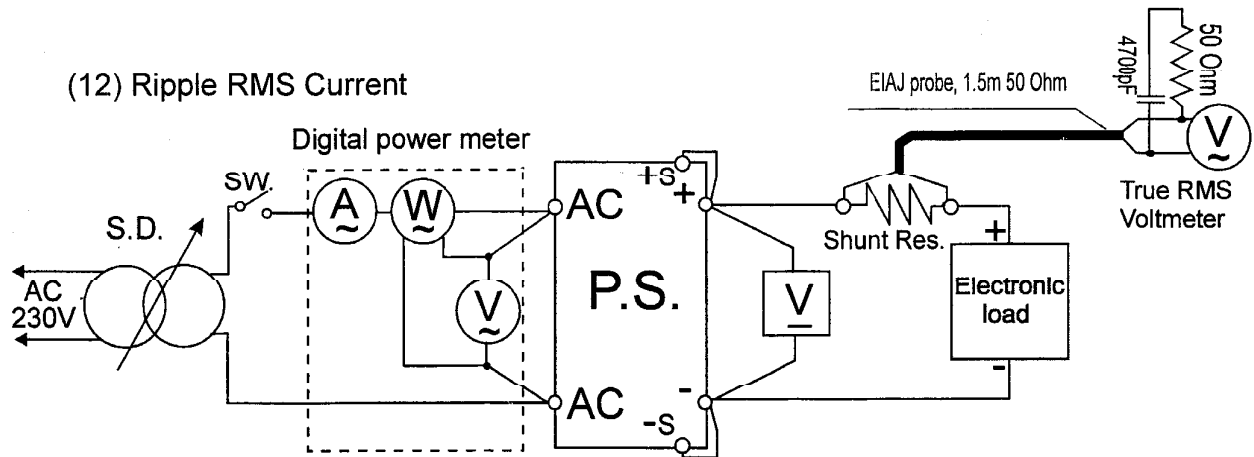

1-2 List of equipment used

	EQUIPMENT USED	MANUFACTURER	MODEL NO.
1	Storage oscilloscope	YOKOGAWA	DL7100
2	Storage oscilloscope	YOKOGAWA	DL1540
3	Analog Oscilloscope	HITACHI	V-1565
4	Digital multimeter	HP	34401A
5	Digital power meter	YOKOGAWA	WT110
6	Autotransformer	VOLTAC	B15
7	Dynamic electronic load	KIKUSUI	PLZ1003W
8	Electronic DC load	TAKASAGO	FK-1000H
9	Controlled temp. Chamber	THERMOTRON	SE-600-5-5
10	AC power supply (CVCF)	KIKUSUI	PCR4000L
11	Analyzing AC power supply	TAKASAGO	AA2000XG
12	Inrush current tester	TAKAMISAWA	PSA-210
13	Leakage current tester	HIOKI	3155
14	Current probe	TEKTRONIX	P6021
15	RMS voltmeter	HP	3400A

2.CHARACTERISTICS

GEN1500

2-1.Steady state data

(1).REGULATION - Line & Load,temperature drift
Constant Voltage Mode

1.Regulation - Line & Load

Condition Ta: 25°C

GEN6-200

lout \ Vin	AC 85V	AC 100V	AC 200V	AC 265V	Line Regulation	
	0%	6.0067 v	6.0067 v	6.0067 v	6.0067 v	0 mv
50%	6.0059 v	6.0059 v	6.0059 v	6.0059 v	0 mv	0 %
100%	6.0052 v	6.0052 v	6.0052 v	6.0052 v	0 mv	0 %
Load	1.5 mv	1.5 mv	1.5 mv	1.5 mv		
Regulation	0.025%	0.025%	0.025%	0.025%		

2.Temperature drift

Ta	0 °C	25 °C	50 °C	Temp. Stability	
Vout	5.9984 v	5.9994 v	6.0028 v	4.4 mv	0.073 %

Conditions:
Vin : 100VAC
Iout : 100%

1.Regulation - Line & Load

Condition Ta: 25°C

GEN60-25

lout \ Vin	AC 85V	AC 100V	AC 200V	AC 265V	Line Regulation	
	0%	60.000 v	59.998 v	59.998 v	60.000 v	2 mv
50%	59.998 v	59.995 v	59.996 v	59.998 v	3 mv	0.005%
100%	59.996 v	59.994 v	59.994 v	59.996 v	2 mv	0.003%
Load	4 mv	4 mV	4 mv	4 mv		
Regulation	0.0066 %	0.0066 %	0.0066 %	0.0066 %		

2.Temperature drift

Ta	0 °C	25 °C	50 °C	Temp. Stability	
Vout	60.004 v	60.010 v	60.022 v	18 mv	0.03 %

Conditions:
Vin : 100VAC
Iout : 100%

GEN1500

(1).REGULATION - Line & Load,temperature drift
Constant Voltage Mode

1.Regulation - Line & Load

Condition Ta: 25°C

GEN100-15	Iout \ Vin	AC 85V	AC 100V	AC 200V	AC 265V	Line Regulation	
		0%	100.118v	100.118v	100.118v	100.118v	0 mv
	50%	100.118v	100.118v	100.118v	100.118v	0 mv	0 %
	100%	100.119v	100.119v	100.119v	100.119v	0 mv	0 %
	Load	1 mv	1 mv	1 mv	1 mv		
	Regulation	0.001%	0.001%	0.001%	0.001%		

2.Temperature drift

Ta	0 °C	25°C	50 °C	Temp. Stability	
Vout	100.001v	100.005v	100.026v	25 mv	0.025 %

Conditions:
Vin : 100VAC
Iout : 100%

1.Regulation - Line & Load

Condition Ta: 25°C

GEN600-2.6	Iout \ Vin	AC 85V	AC 100V	AC 200V	AC 265V	Line Regulation	
		0%	600.486v	600.486v	600.486v	600.486v	0 mv
	50%	600.489v	600.489v	600.489v	600.489v	0 mv	0%
	100%	600.491v	600.491v	600.492v	600.492v	1 mv	0.0002%
	Load	5 mv	5 mV	6 mv	6 mv		
	Regulation	0.0008 %	0.0008 %	0.001 %	0.001%		

2.Temperature drift

Ta	0 °C	25°C	50 °C	Temp. Stability	
Vout	600.016v	600.093v	600.281v	265 mv	0.044 %

Conditions:
Vin : 100VAC
Iout : 100%

(1).REGULATION - Line & Load,temperature drift

GEN1500

Constant Current Mode

1.Regulation - Line & Load

Condition Ta: 25°C

GEN6-200

Vout \ Vin	AC 85V	AC 100V	AC 200V	AC 265V	Line Regulation	
SHORT	200.284A	200.284A	200.284A	200.284A	0 mA	0 %
50%	200.286 A	200.286A	200.284A	200.284A	2 mA	0.001 %
100%	200.308 A	200.308A	200.306A	200.304A	4 mA	0.002 %
Load	24 mA	24 mA	22 mA	20 mA		
Regulation	0.012 %	0.012 %	0.011 %	0.01 %		

2. Temperature drift

Ta	0 °C	25°C	50 °C	Temp. Stability	
Iout	200.404A	200.464A	200.630A	226mA	0.113 %

Conditions:
Vin : 100VAC
Vout : 90%

1.Regulation - Line & Load

Condition Ta: 25°C

GEN60-25

Vout \ Vin	AC 85V	AC 100V	AC 200V	AC 265V	Line Regulation	
SHORT	25.003A	25.003A	25.003A	25.003 A	0 mA	0 %
50%	25.007 A	25.008A	25.008A	25.008 A	1 mA	0.004 %
100%	25.005 A	25.007A	25.006A	25.006 A	2 mA	0.008 %
Load	4 mA	5 mA	5 mA	5 mA		
Regulation	0.016 %	0.02 %	0.02 %	0.02 %		

2. Temperature drift

Ta	0 °C	25°C	50 °C	Temp. Stability	
Iout	25.018 A	25.022A	25.028A	10 mA	0.04%

Conditions:
Vin : 100VAC
Vout : 90%

(1).REGULATION - Line & Load,temperature drift

GEN1500

Constant Current Mode

1.Regulation - Line & Load

Condition Ta: 25°C

GEN100-15	Vout \ Vin	AC 85V	AC 100V	AC 200V	AC 265V	Line Regulation	
	SHORT	15.024 A	15.024 A	15.024 A	15.024 A	0 mA	0 %
	50%	15.028 A	15.028 A	15.028 A	15.028 A	0 mA	0 %
	100%	15.027 A	15.027 A	15.027 A	15.027 A	0 mA	0 %
	Load	4 mA	4 mA	4 mA	4 mA		
Regulation	0.027 %	0.027 %	0.027 %	0.027 %			

2. Temperature drift

Ta	0 °C	25°C	50 °C	Temp. Stability
Iout	15.727 A	15.724 A	15.734 A	10 mA 0.067%

Conditions:
Vin : 100VAC
Vout : 90%

1.Regulation - Line & Load

Condition Ta: 25°C

GEN600-2.6	Vout \ Vin	AC 85V	AC 100V	AC 200V	AC 265V	Line Regulation	
	SHORT	2.6083A	2.6083A	2.6083A	2.6083A	0 mA	0 %
	50%	2.608 A	2.608 A	2.608 A	2.608 A	0 mA	0 %
	100%	2.605 A	2.605 A	2.605 A	2.605 A	0 mA	0 %
	Load	3.3 mA	3.3 mA	3.3 mA	3.3 mA		
Regulation	0.127 %	0.127 %	0.127 %	0.127 %			

2. Temperature drift

Ta	0 °C	25°C	50 °C	Temp. Stability
Iout	2.7265 A	2.7258 A	2.7253 A	1.2 mA 0.046%

Conditions:
Vin : 100VAC
Vout : 90%

(2) Output voltage and ripple voltage v.s. input voltage

GEN1500

Constant Voltage Mode

Conditions $I_{out} : 100\%$
 $T_a : 0^\circ\text{C}$ -----
 25°C -----
 50°C _____

GEN6-200

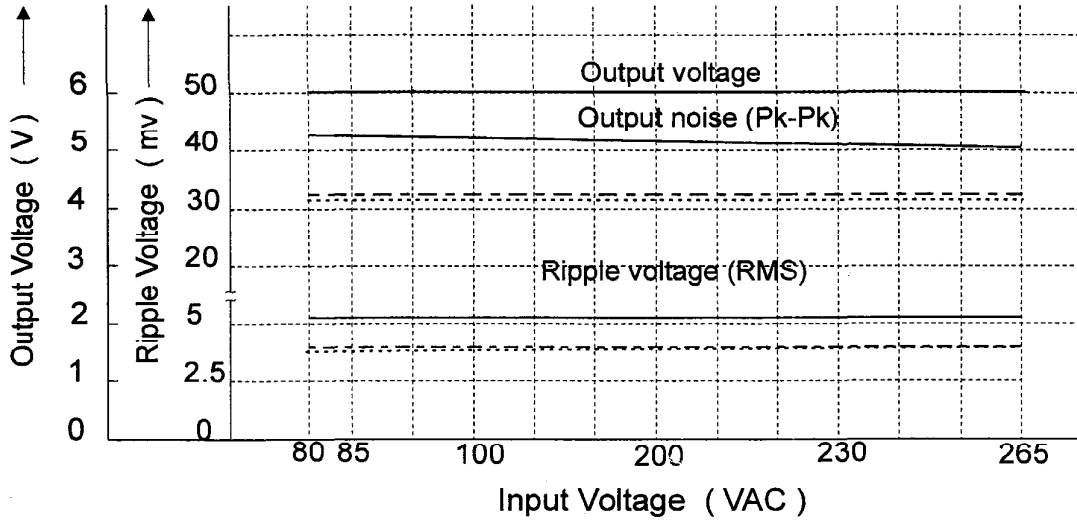

GEN60-25

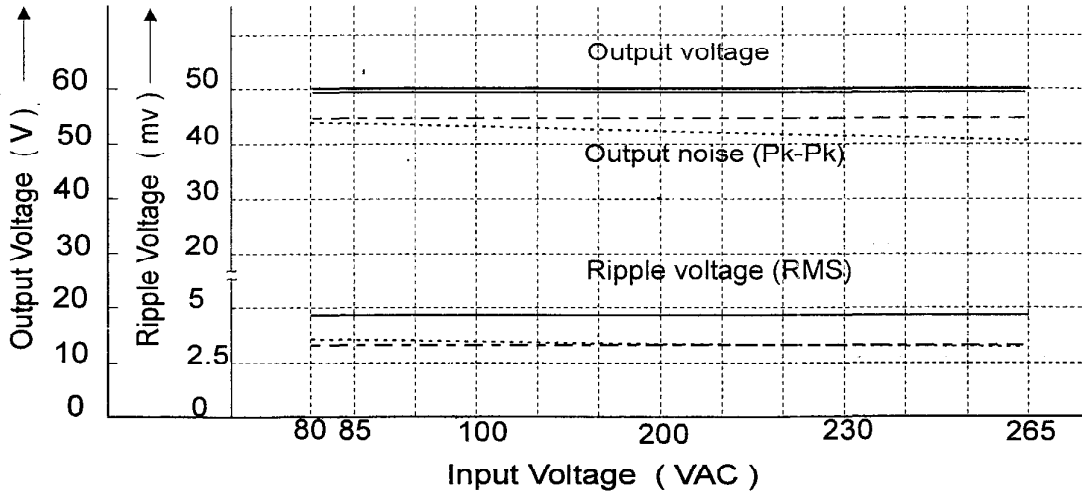

(2) Output voltage and ripple voltage v.s.input voltage

GEN1500

Constant Voltage Mode

Conditions $I_{out} : 100\%$
 $T_a : 0^\circ\text{C}$ -----
 25°C -----
 50°C _____

GEN100-15

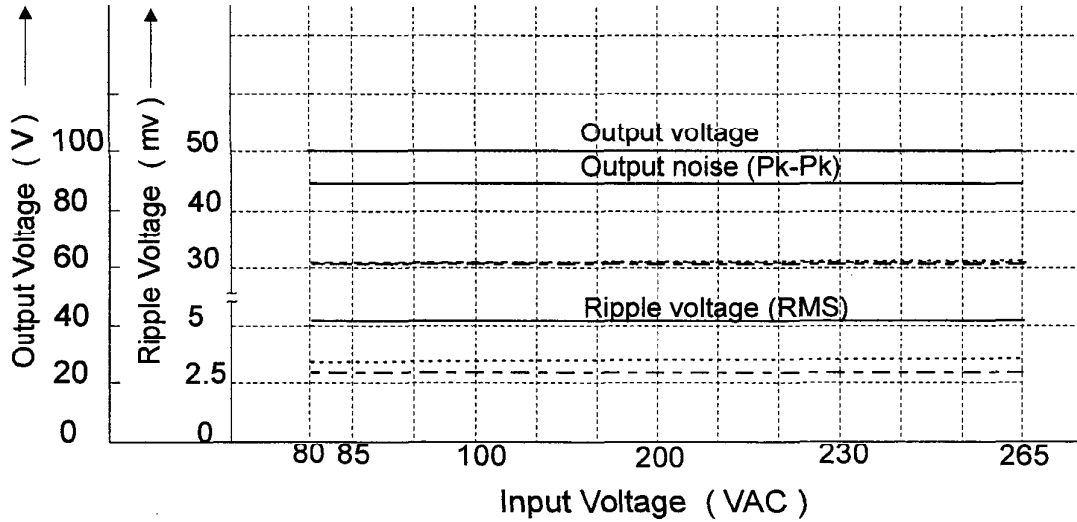

GEN600-2.6

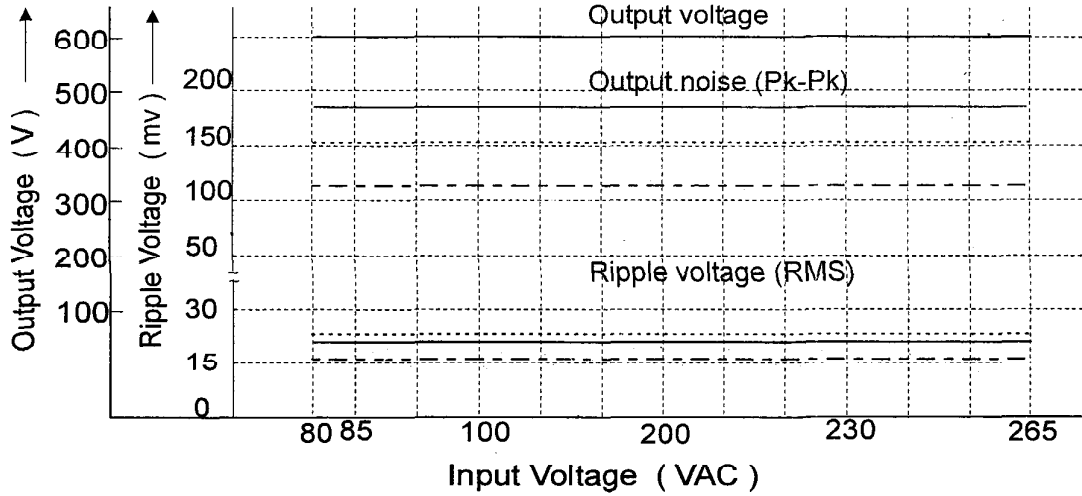

(3).Efficiency and Input current v.s. Output current

Constant Voltage Mode

GEN1500

Condition V_{in} : AC 100 V

V_{out} :100%

T_a : 25°C

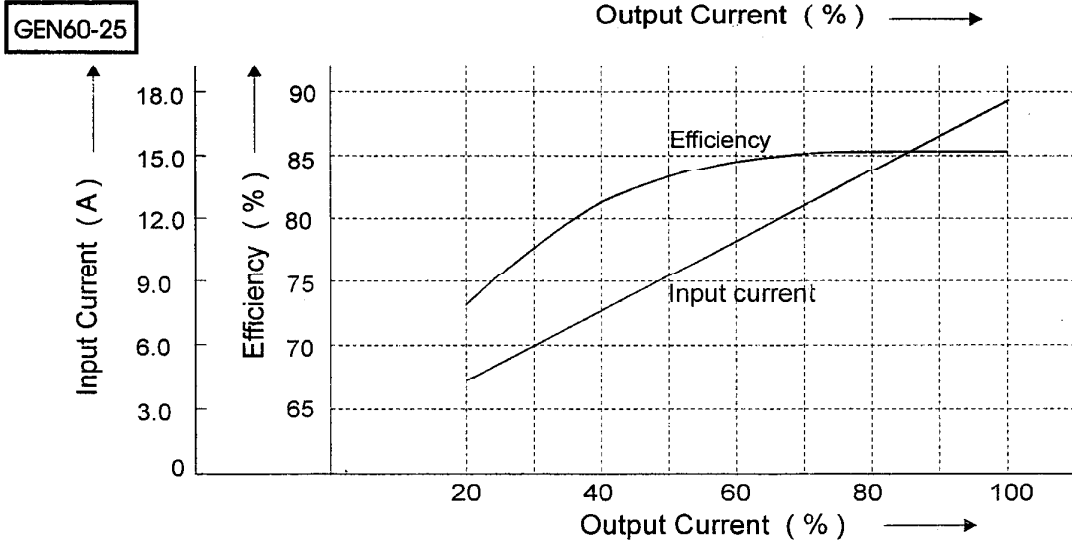
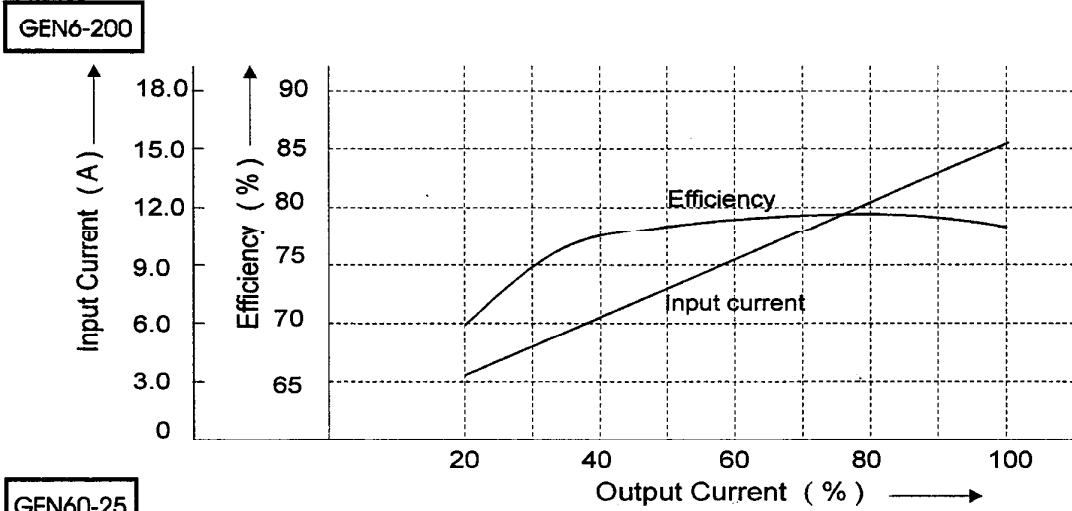

(3). Efficiency and Input current v.s. Output current

Constant Voltage Mode

GEN1500

Condition V_{in} : AC 100 V

V_{out} :100%

T_a : 25°C

GEN100-15

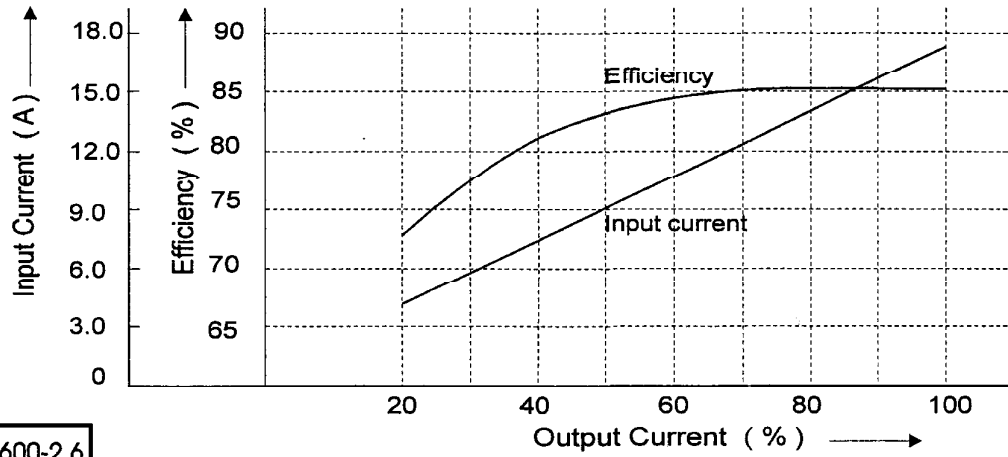

GEN600-2.6

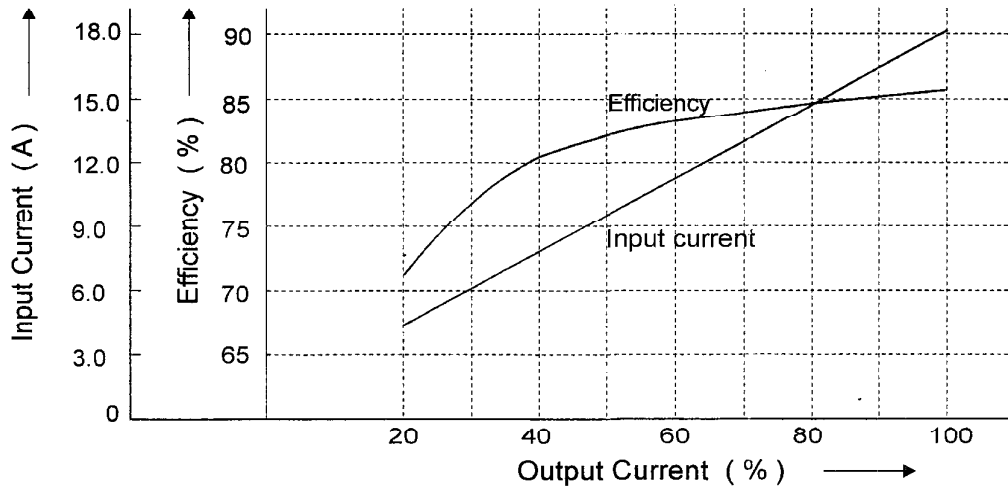

(3).Efficiency and Input current v.s. Output current

Constant Voltage Mode

GEN1500

Condition Vin : AC 200 V

Vout:100%

Ta: 25°C

GEN6-200

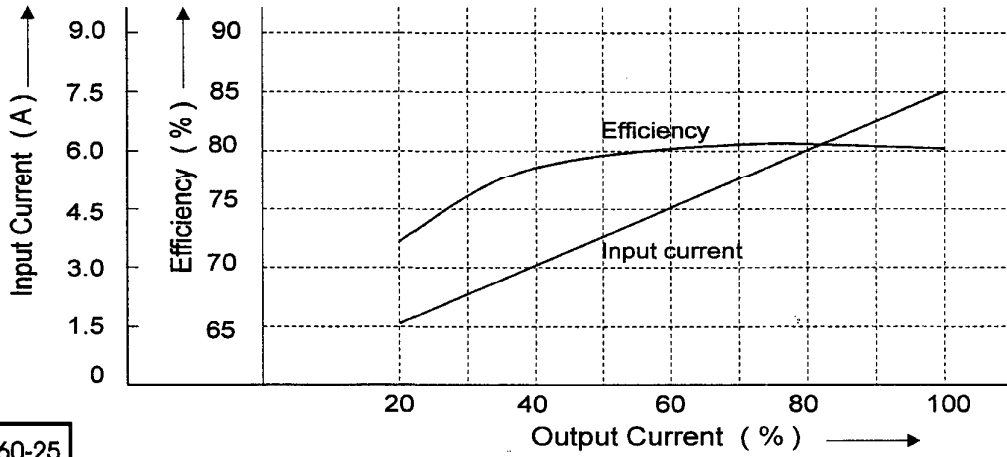

GEN60-25

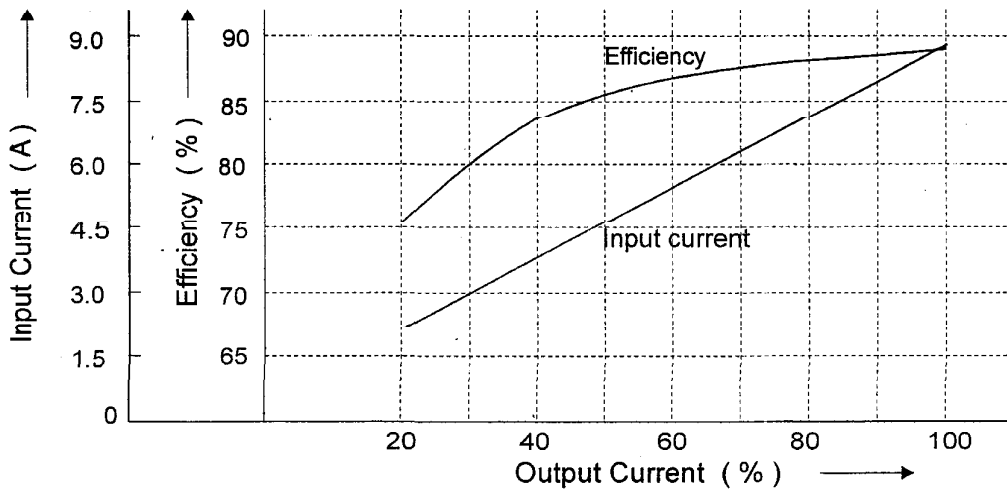

(3). Efficiency and Input current v.s. Output current

Constant Voltage Mode

GEN1500

Condition V_{in} : AC 200 V

V_{out} : 100%

T_a : 25°C

GEN100-15

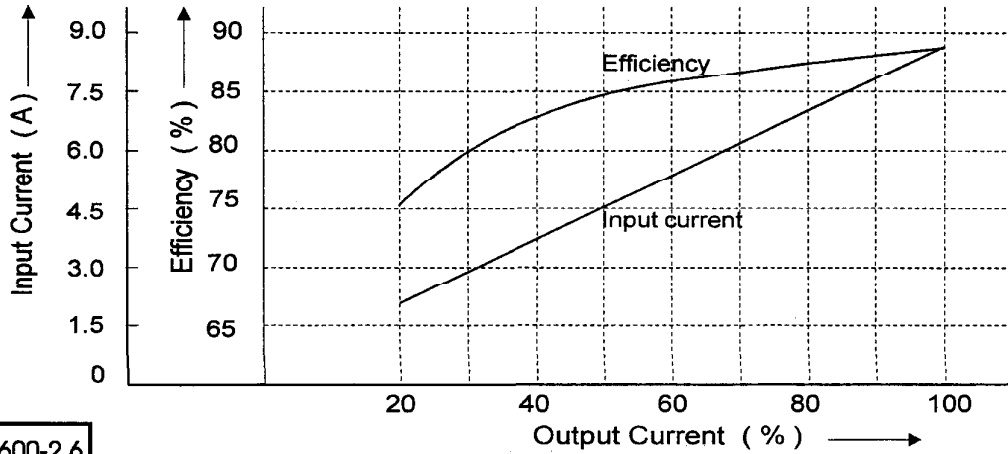

GEN600-2.6

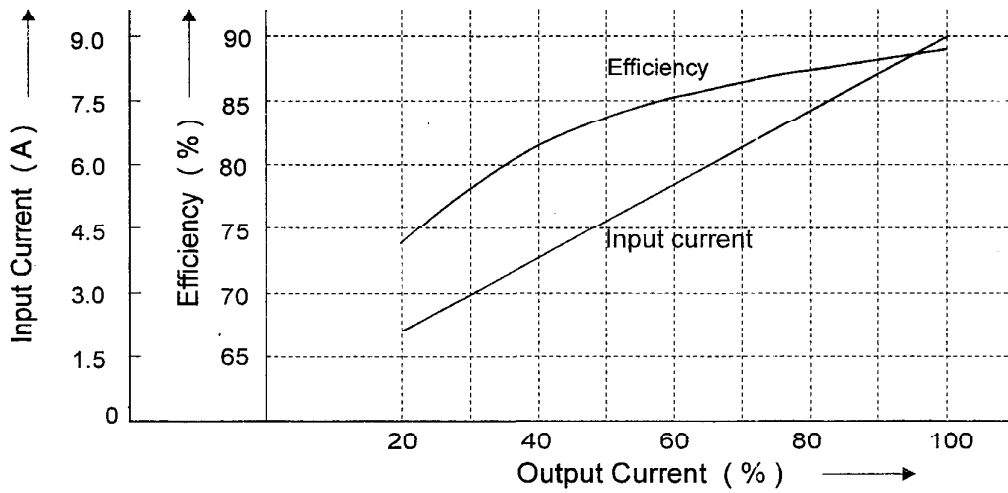

2-2. Warm up voltage drift characteristics

GEN1500

Constant Voltage Mode

Conditions Vin: 100VAC
Vout : 100%
Iout : 100%
Ta : 25°C

GEN6-200

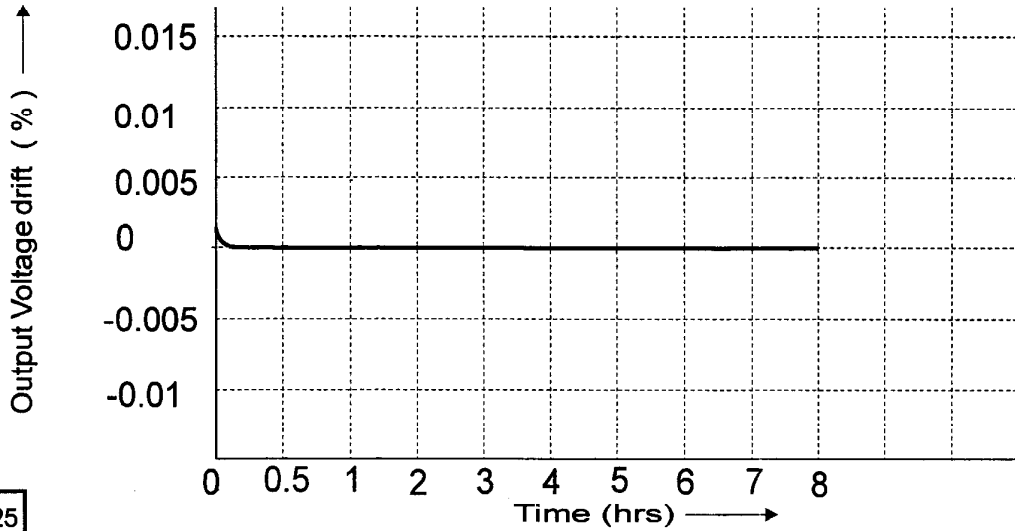

GEN60-25

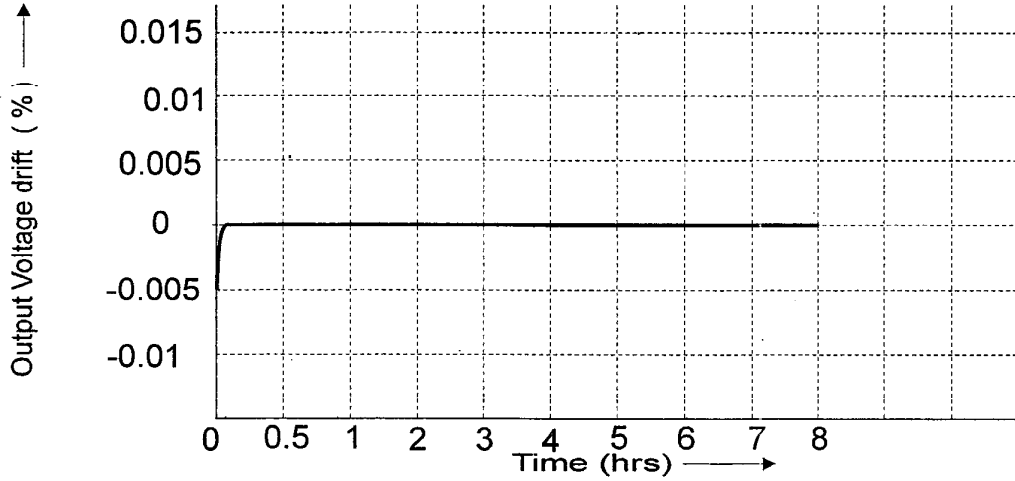

Warm up voltage drift characteristics

Constant Voltage Mode

GEN1500

Conditions Vin: 100VAC
Vout : 100%
Iout : 100%
Ta : 25°C

GEN100-15

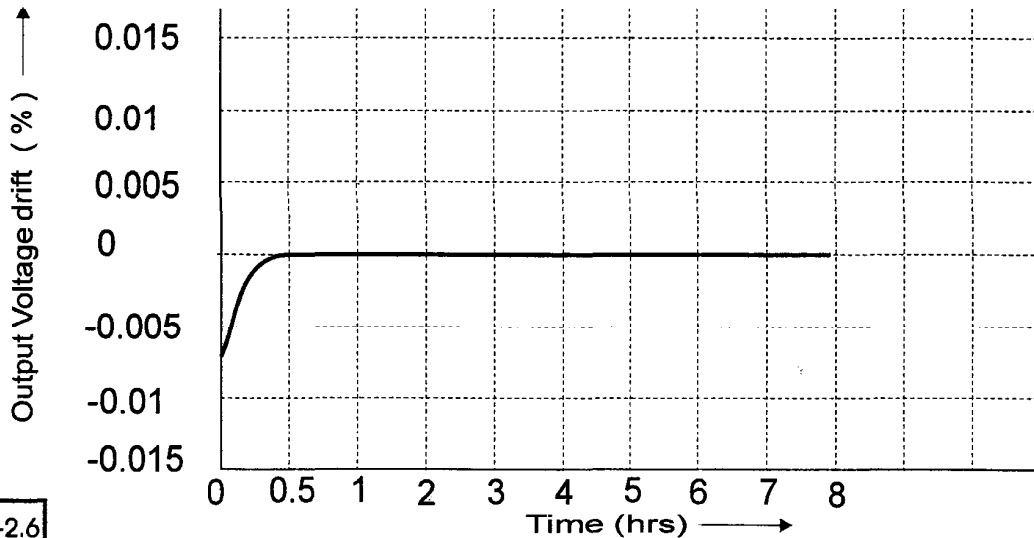

GEN600-2.6

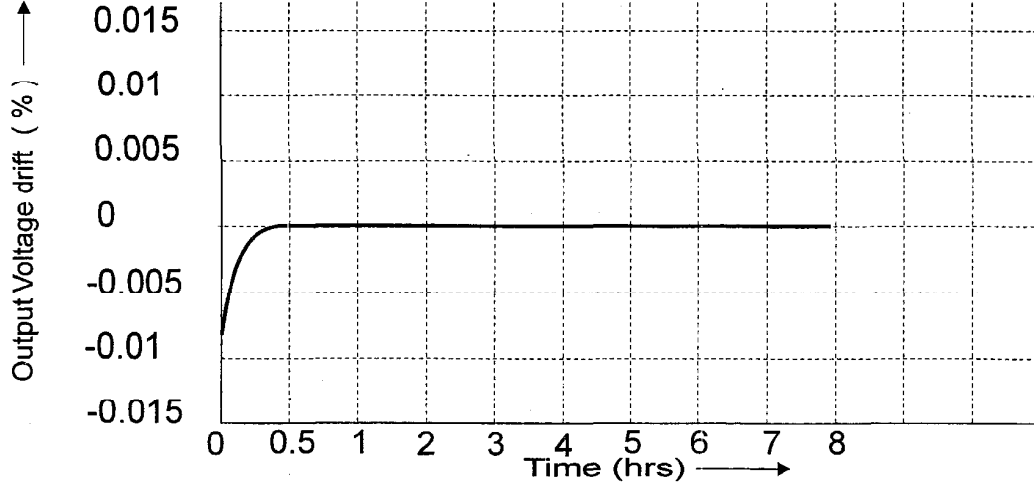

Warm up current drift characteristics

Constant Current Mode

GEN1500

Conditions V_{in} : 100VAC

V_{out} : 100%

I_{out} : 100%

T_a : 25°C

GEN6-200

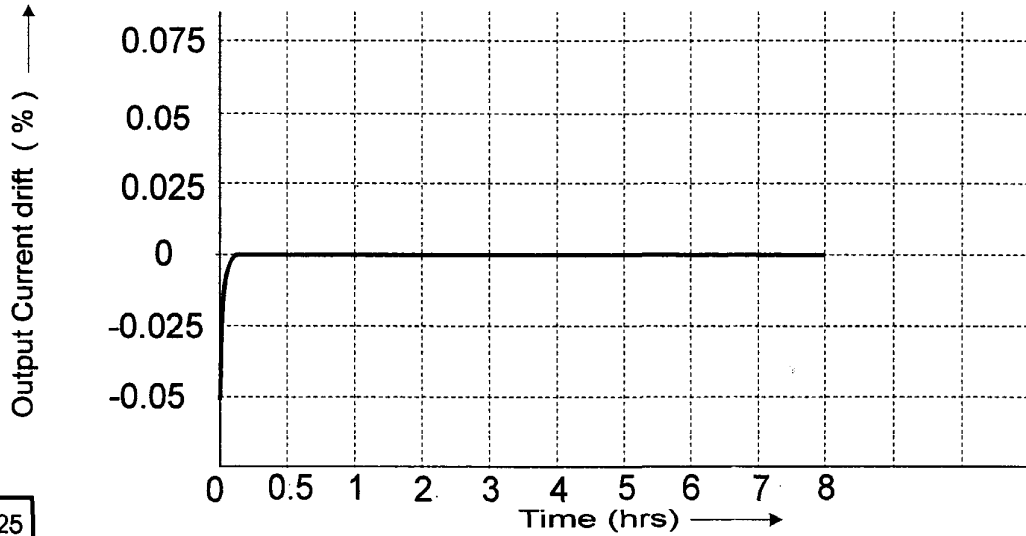

GEN60-25

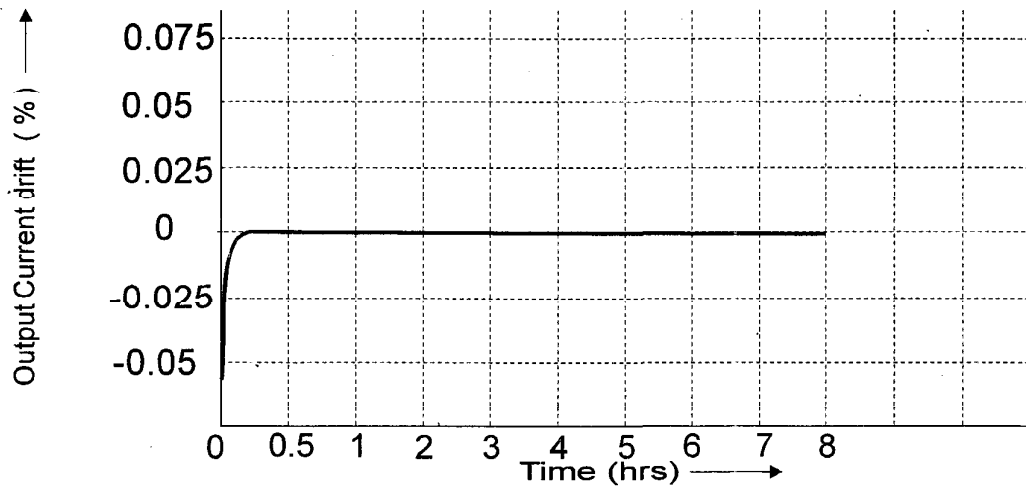

Warm up current drift characteristics

Constant Current Mode

GEN1500

Conditions Vin: 100VAC

Vout : 100%

Iout : 100%

Ta : 25°C

GEN100-15

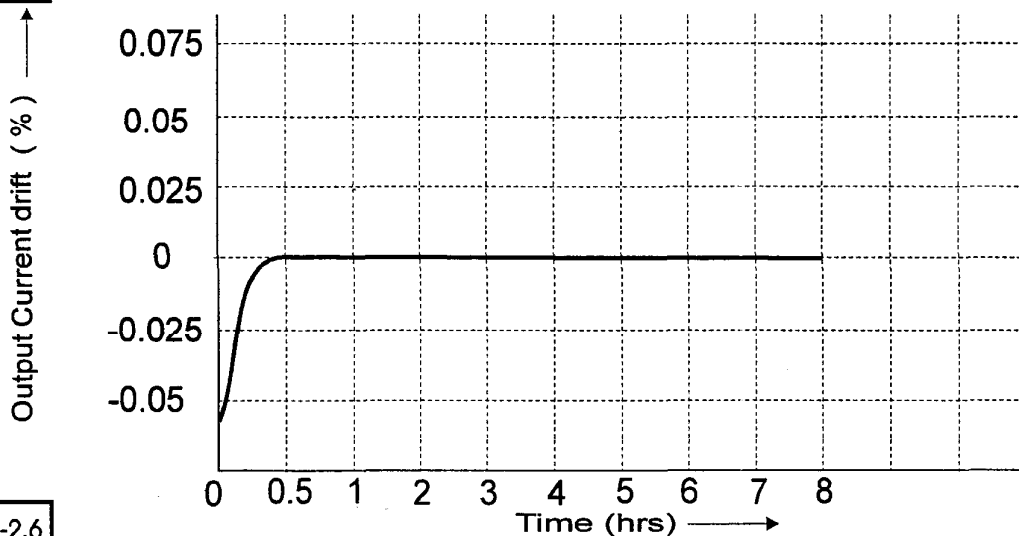

GEN600-2.6

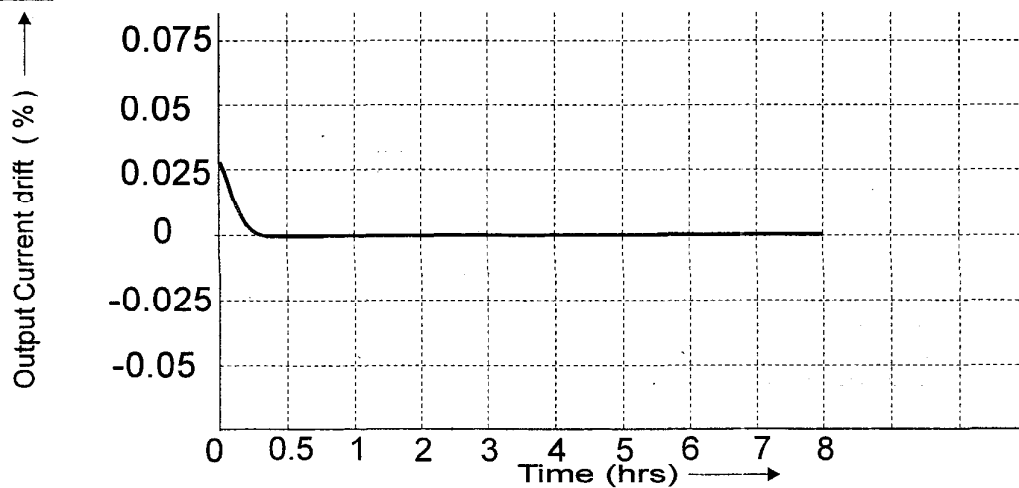

2-3. Over voltage protection (OVP) Characteristics
Constant Voltage Mode

GEN1500

Conditions Vin: 100VAC
Iout:0%
Ta:25°C

GEN6-200

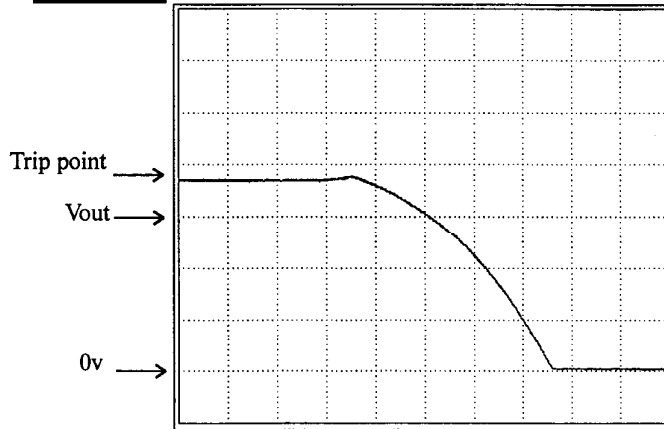

OVP setting:7.5V

2V/DIV 100ms/DIV

GEN60-25

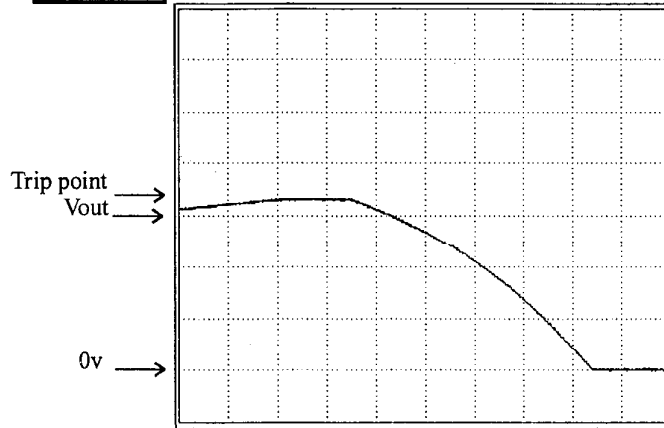

OVP setting:66V

20V/DIV 200ms/DIV

Over voltage protection (OVP) Characteristics
Constant Voltage Mode

GEN1500

Conditions Vin: 100VAC
Iout:0%
Ta:25°C

GEN100-15

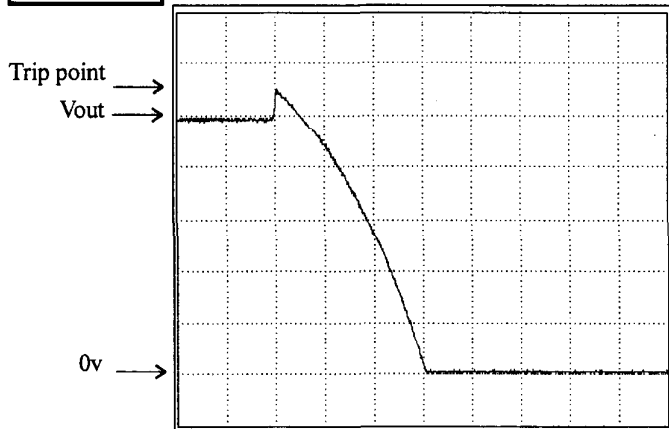

OVP setting:110V

20V/DIV 500ms/DIV

GEN600-2.6

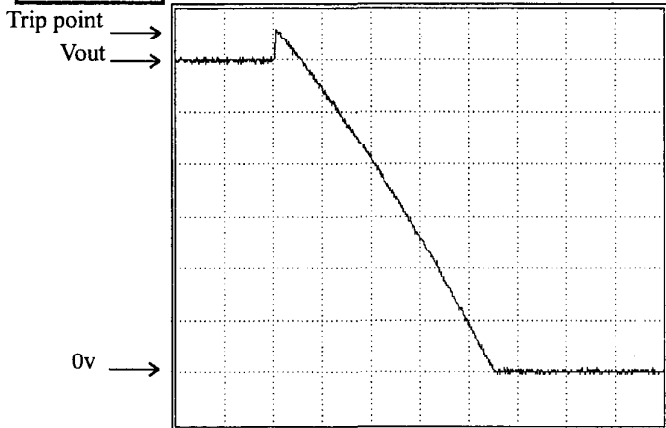

OVP setting:660V

100V/DIV 1s/DIV

2-4. Output Rise Characteristics

Constant Voltage Mode

GEN1500

Conditions Vin: 100VAC
Vout: 100%
Iout: 0%
Ta: 25°C

GEN6-200

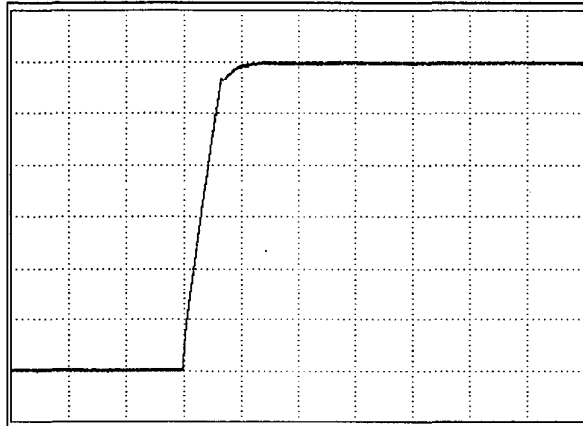

← Vout

← 0v

1V/DIV

5ms/DIV

GEN60-25

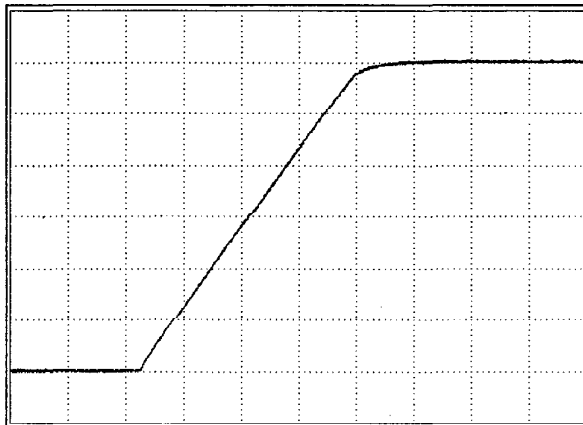

← Vout

← 0v

10V/DIV

5ms/DIV

Output Rise Characteristics
Constant Voltage Mode

GEN1500

Conditions Vin: 100VAC
Vout: 100%
Iout: 0%
Ta: 25°C

GEN100-15

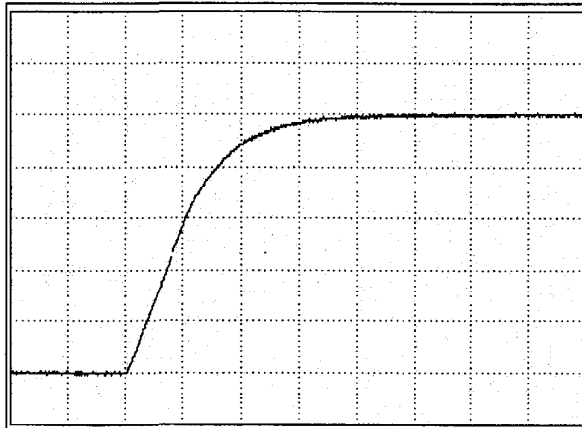

← Vout

← 0v

20V/DIV | 10ms/DIV

GEN600-2.6

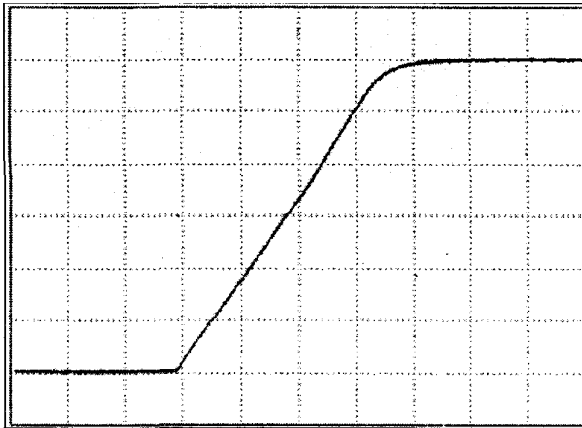

← Vout

← 0v

100V/DIV | 20ms/DIV

Output Rise Characteristics
Constant Voltage Mode

GEN1500

Conditions Vin: 100VAC
Vout: 100%
Iout: 100%
Ta: 25 °C

GEN6-200

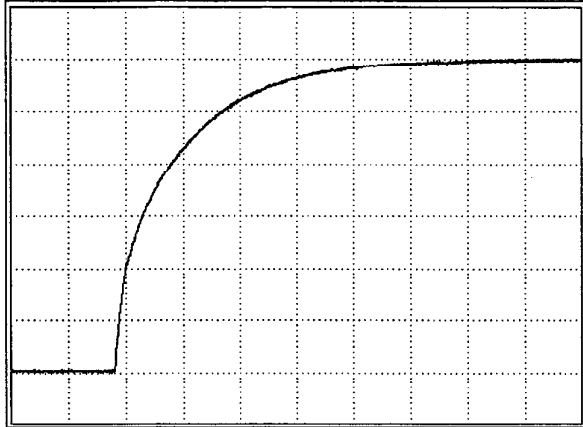

← Vout

← 0v

1V/DIV

5ms/DIV

GEN60-25

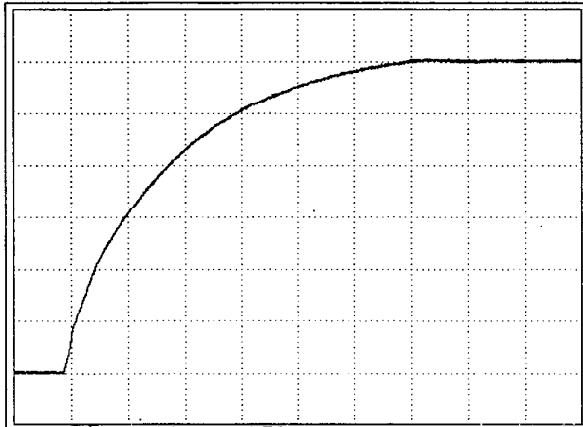

← Vout

← 0v

10V/DIV

10ms/DIV

Output Rise Characteristics
Constant Voltage Mode

GEN1500

Conditions Vin: 100VAC
Vout:100%
Iout:100%
Ta:25°C

GEN100-15

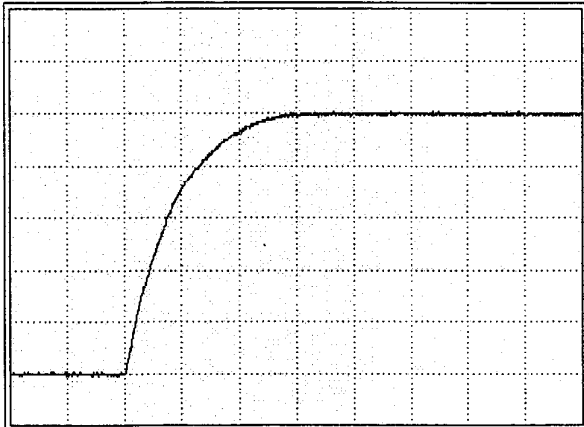

← Vout
← 0v

20V/DIV 20ms/DIV

GEN600-2.6

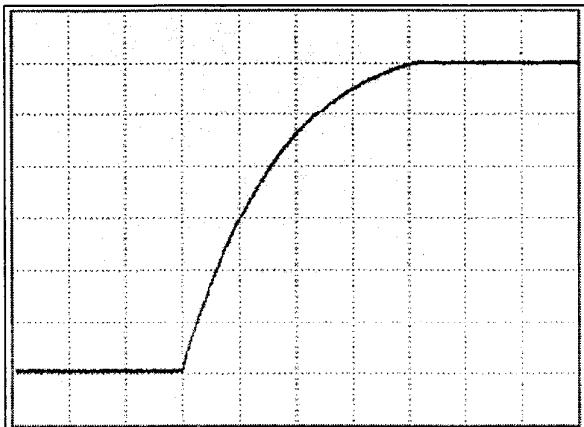

← Vout
← 0v

100V/DIV 50ms/DIV

Output Rise Characteristics
Constant Current Mode

GEN1500

Conditions V_{in} : 100VAC
 V_{out} : 100%
 I_{out} : 100%
Load: Constant Resistance
 T_a : 25°C

GEN6-200

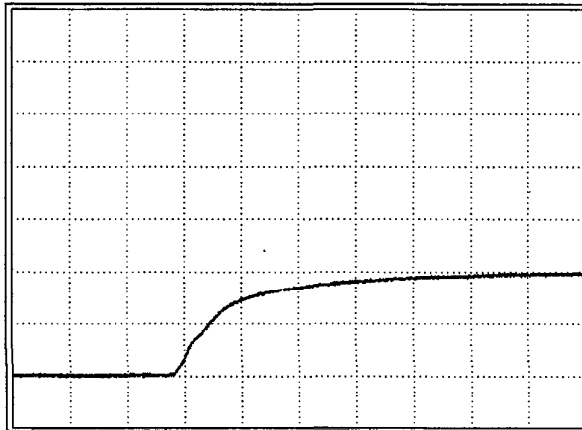

← I_{out}

← 0A

100A/DIV 2ms/DIV

GEN60-25

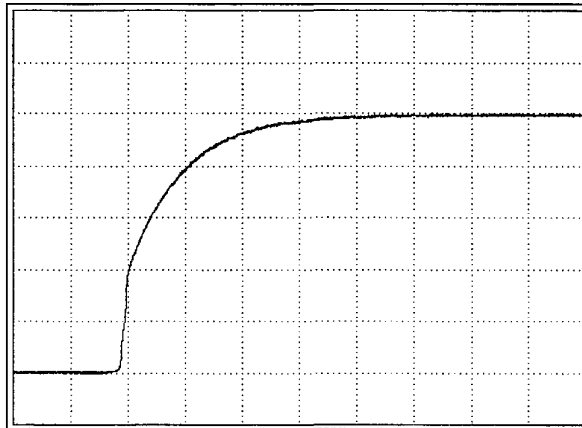

← I_{out}

← 0A

5A/DIV 20ms/DIV

Output Rise Characteristics
Constant Current Mode

GEN1500

Conditions V_{in} : 100VAC
 V_{out} : 100%
 I_{out} : 100%
Load: Constant Resistance
 T_a : 25°C

GEN100-15

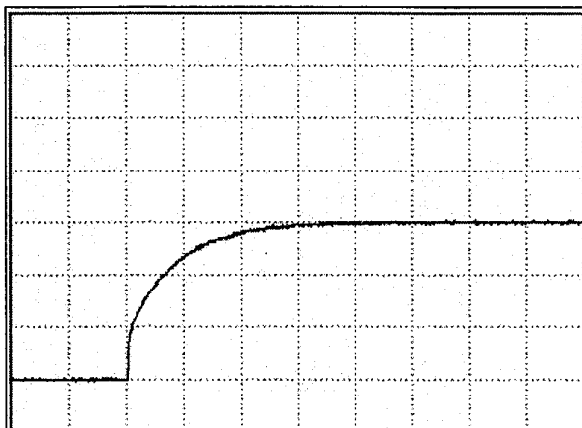

← I_{out}

← 0A

5A/DIV

20ms/DIV

GEN600-2.6

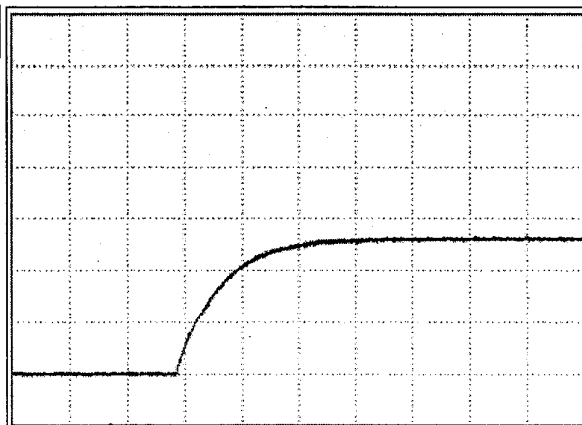

← I_{out}

← 0A

1A/DIV

100ms/DIV

Output Rise Characteristics
Constant Current Mode

GEN1500

Conditions V_{in} : 100VAC
Start to short circuit
 I_{out} : 100%
 T_a : 25°C

GEN6-200

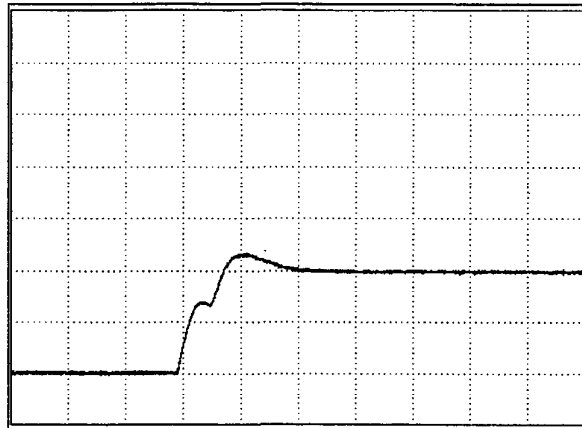

← I_{out}

← 0A

100A/DIV 2ms/DIV

GEN60-25

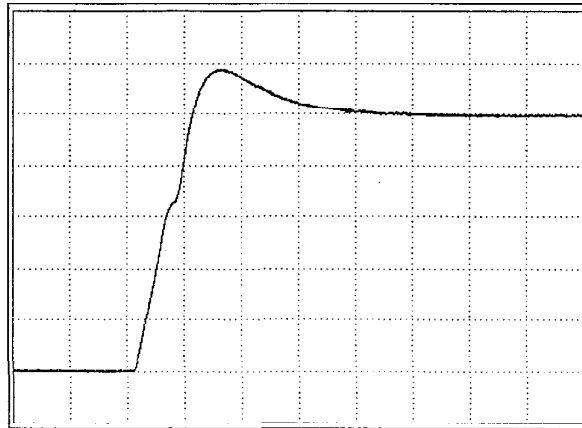

← I_{out}

← 0A

5A/DIV 0.5ms/DIV

Output Rise Characteristics
Constant Current Mode

GEN1500

Conditions V_{in} : 100VAC
Start to short circuit
 I_{out} : 100%
 T_a : 25°C

GEN100-15

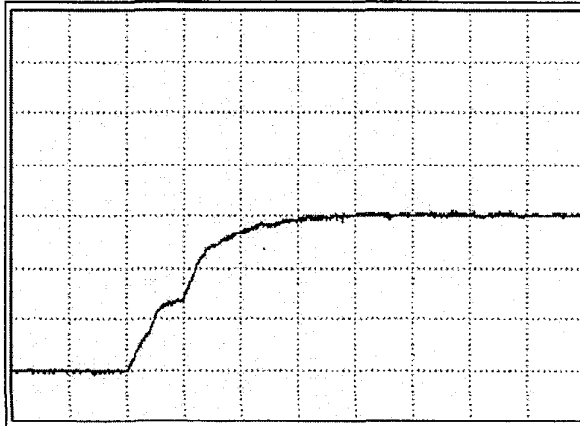

← I_{out}

← 0A

5A/DIV

20ms/DIV

GEN600-2.6

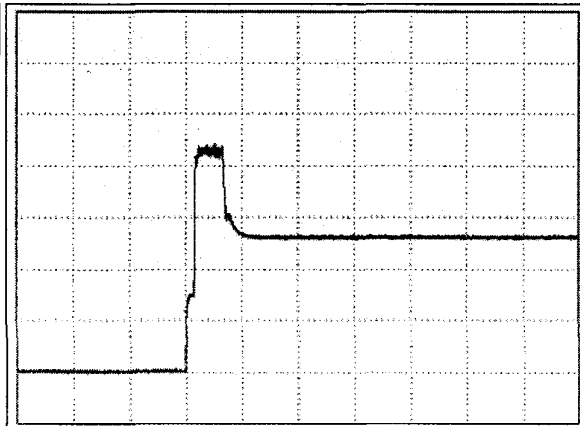

← I_{out}

← 0A

1A/DIV

5ms/DIV

2-5. Output Fall Characteristics

Constant Voltage Mode

GEN1500

Conditions Vin: 100VAC
Vout: 100%
Iout: 0%
Ta: 25°C

GEN6-200

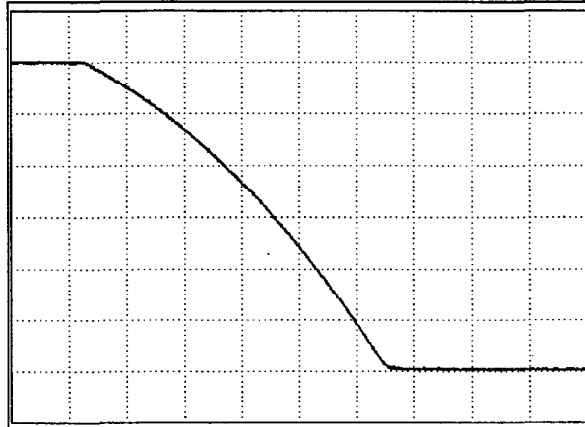

← Vout

← 0v

1V/DIV

50ms/DIV

GEN60-25

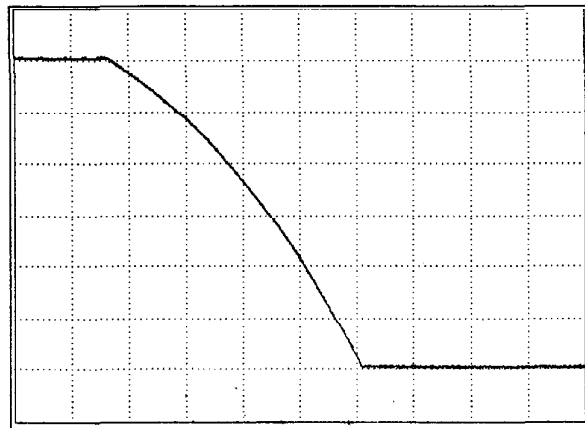

← Vout

← 0v

10V/DIV

200ms/DIV

Output Fall Characteristics
Constant Voltage Mode

GEN1500

Conditions Vin: 100VAC
Vout: 100%
Iout: 0%
Ta: 25°C

GEN100-15

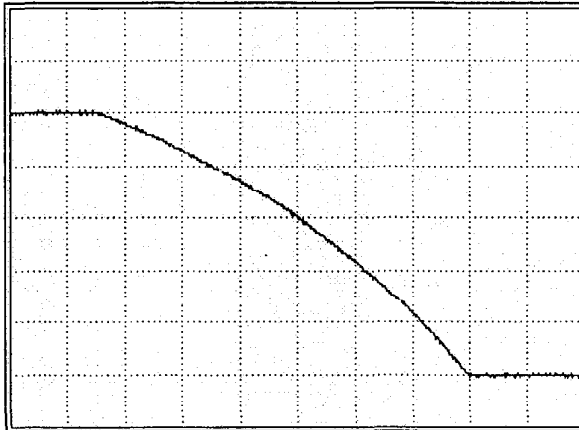

← Vout

← 0v

20V/DIV 200ms/DIV

GEN600-2.6

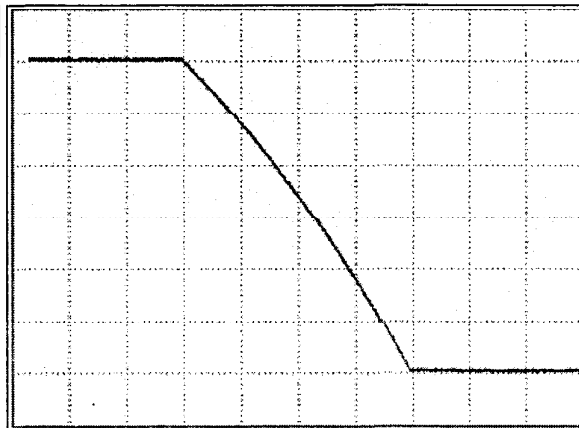

← Vout

← 0v

100V/DIV 1s/DIV

Output Fall Characteristics
Constant Voltage Mode

GEN1500

Conditions Vin: 100VAC
Vout: 100%
Iout: 100%
Ta: 25°C

GEN6-200

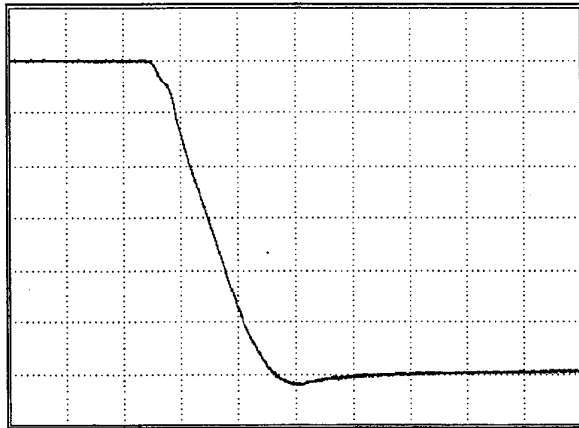

← Vout

← 0v

1V/DIV 0.5ms/DIV

GEN60-25

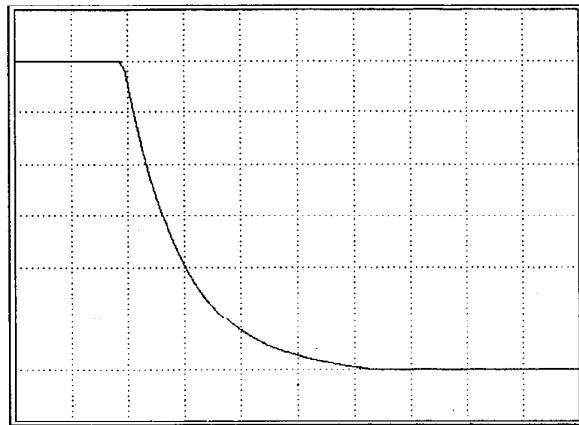

← Vout

← 0v

10V/DIV 5ms/DIV

Output Fall Characteristics
Constant Voltage Mode

GEN1500

Conditions Vin: 100VAC
Vout: 100%
Iout: 100%
Ta: 25°C

GEN100-15

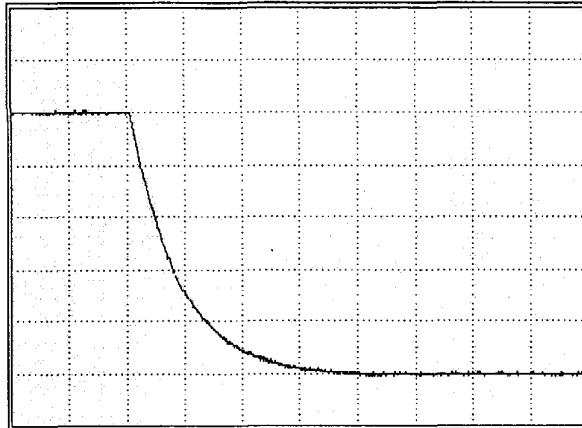

← Vout

← 0v

20V/DIV 10ms/DIV

GEN600-2.6

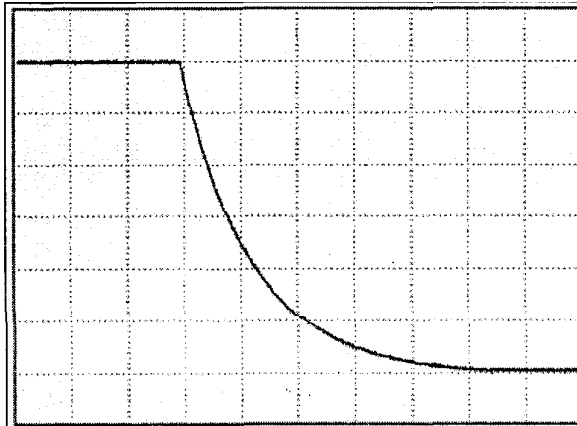

← Vout

← 0v

100V/DIV 50ms/DIV

Output Fall Characteristics
Constant Current Mode

GEN1500

Conditions V_{in} : 100VAC
 V_{out} : 100%
 I_{out} : 100%
Load: Constant Resistance
 T_a : 25°C

GEN6-200

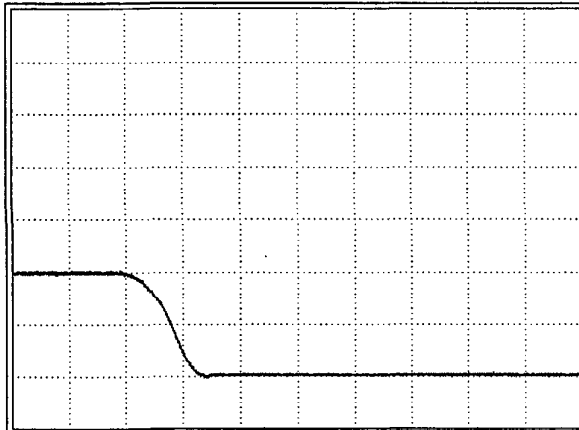

← I_{out}

← 0A

100A/DIV 1ms/DIV

GEN60-25

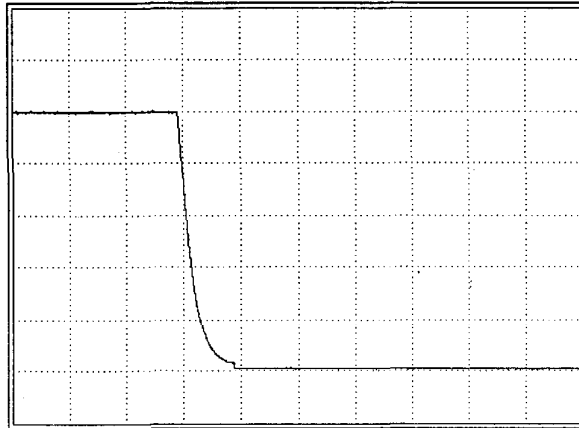

← I_{out}

← 0A

5A/DIV 20ms/DIV

Output Fall Characteristics
Constant Current Mode

GEN1500

Conditions V_{in} : 100VAC
 V_{out} : 100%
 I_{out} : 100%
Load: Constant Resistance
 T_a : 25°C

GEN100-15

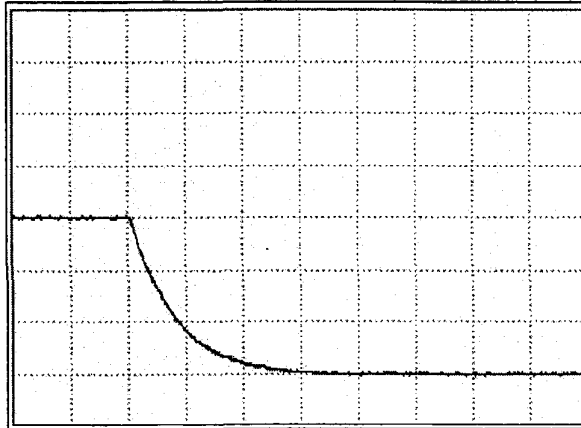

← I_{out}

← 0A

5A/DIV

10ms/DIV

GEN600-2.6

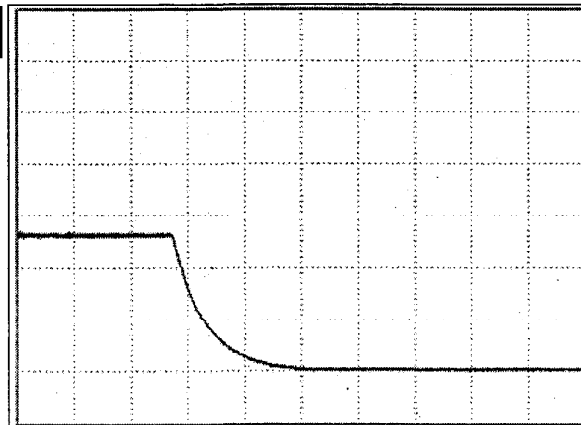

← I_{out}

← 0A

1A/DIV

100ms/DIV

Output Fall Characteristics
Constant Current Mode

GEN1500

Conditions Vin: 100VAC
Fall to short circuit
Iout: 100%
Ta: 25°C

GEN6-200

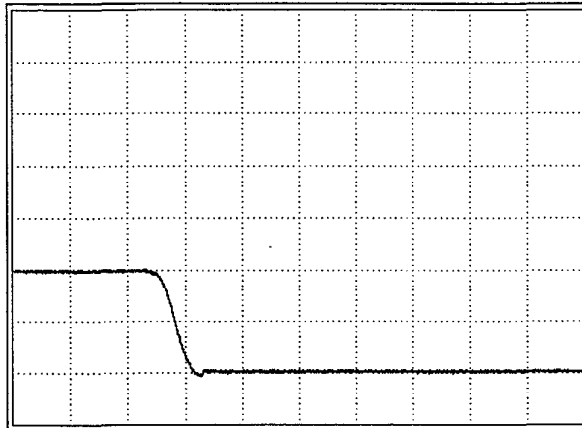

← Iout

← 0A

100A/DIV

1ms/DIV

GEN60-25

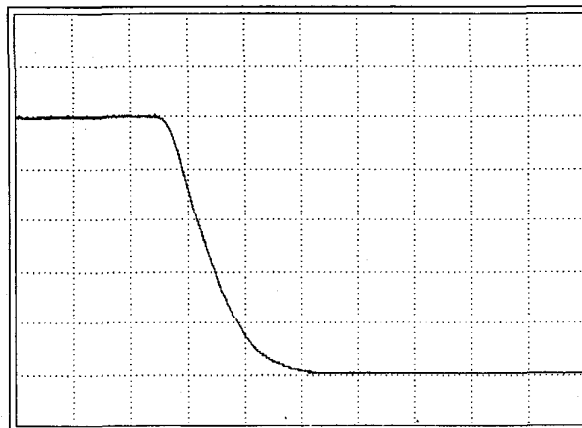

← Iout

← 0A

5A/DIV

0.5ms/DIV

Output Fall Characteristics
Constant Current Mode

GEN1500

Conditions V_{in} : 100VAC
Fall to short circuit
 I_{out} : 100%
 T_a : 25°C

GEN100-15

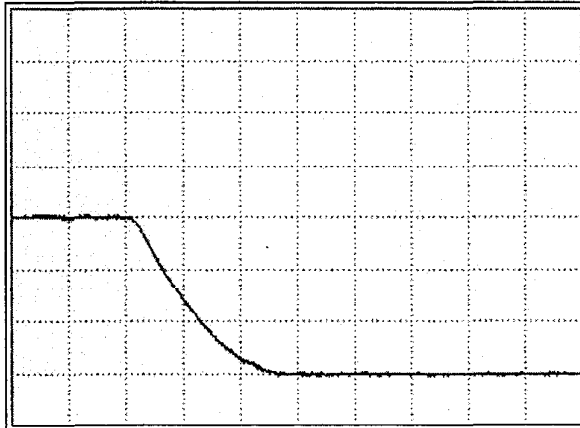

← I_{out}

← 0A

5A/DIV 0.5ms/DIV

GEN600-2.6

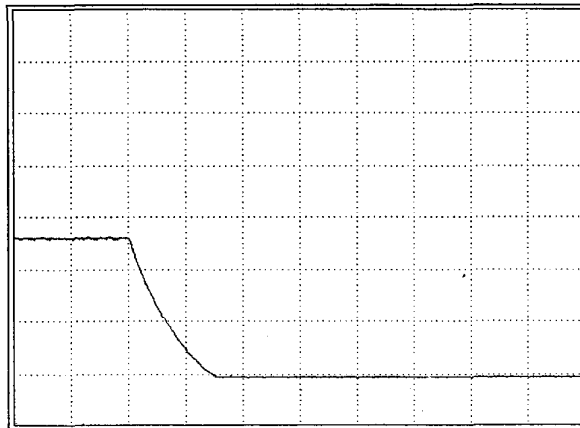

← I_{out}

← 0A

1A/DIV 1ms/DIV

2-6. Hold Up Time Characteristics

Constant Voltage Mode

GEN1500

Conditions: Vout: 100%

AC 100 V ———

AC 200V - - - - -

Ta : 25°C

GEN6-200

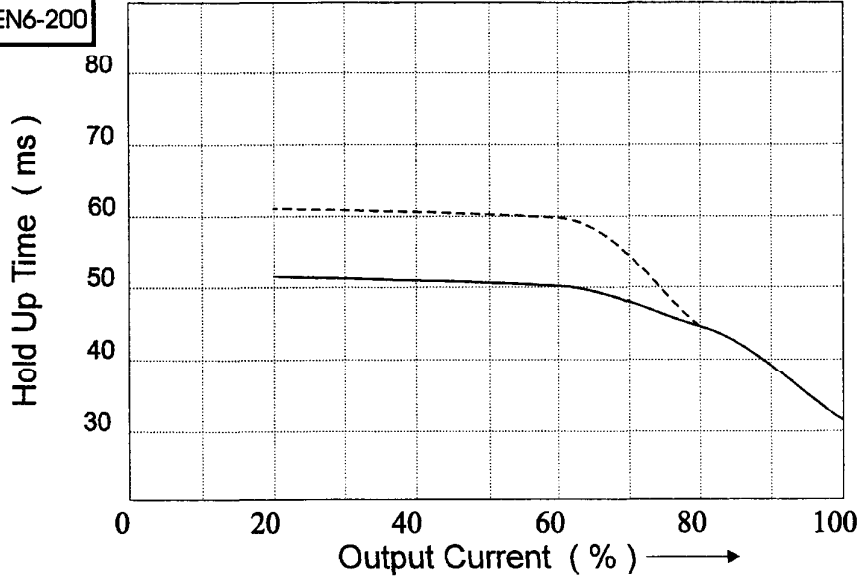

GEN60-25

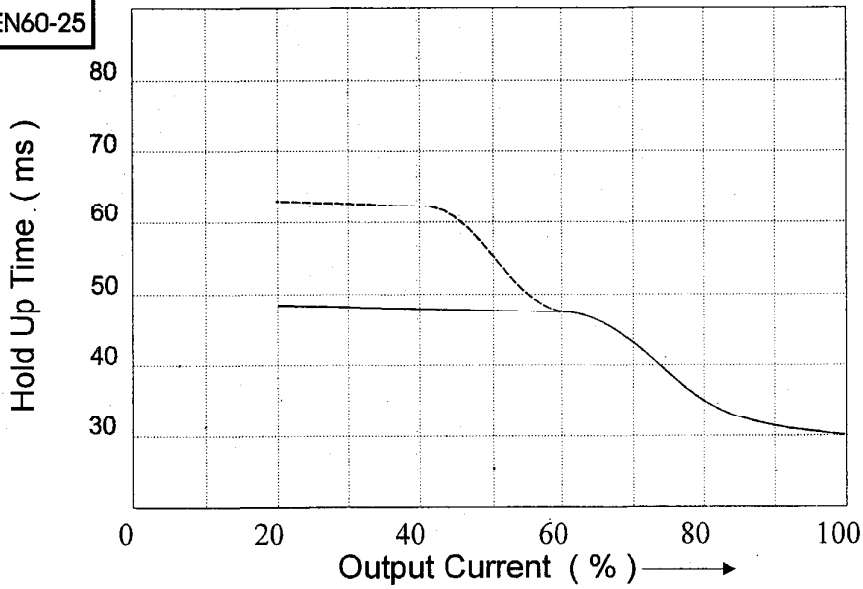

Hold Up Time Characteristics

Constant Voltage Mode

GEN1500

Conditions: Vout: 100%

AC 100V

AC 200V

Ta : 25°C

GEN100-15

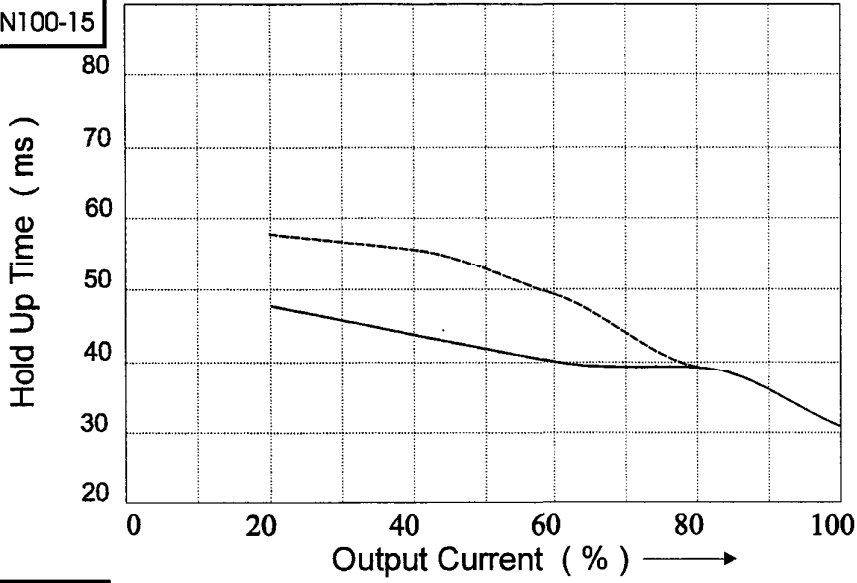

GEN600-2.6

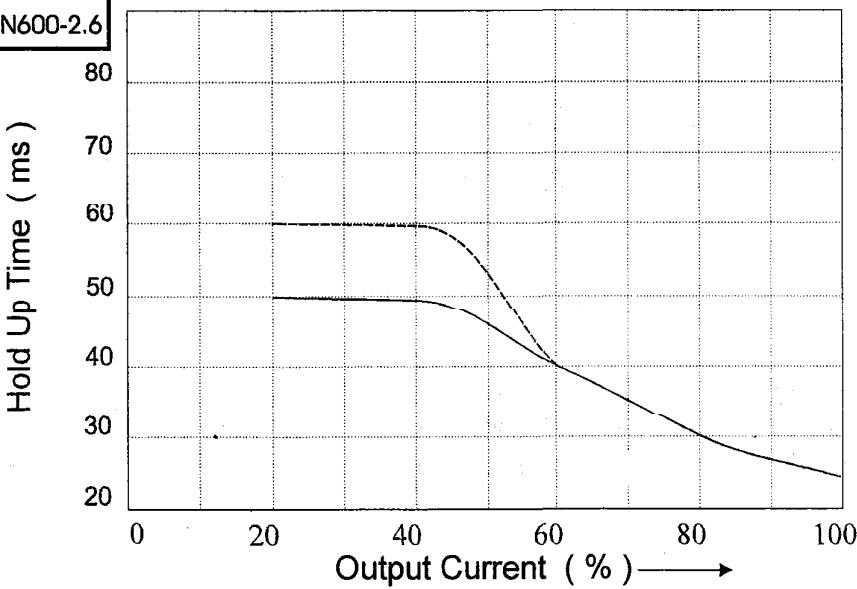

2-7. Dynamic Line Response
Constant Voltage Mode

GEN1500

Conditions : Vout:100%
Iout:100%
Vin: 85 \longleftrightarrow 132 VAC
Ta : 25°C

GEN6-200

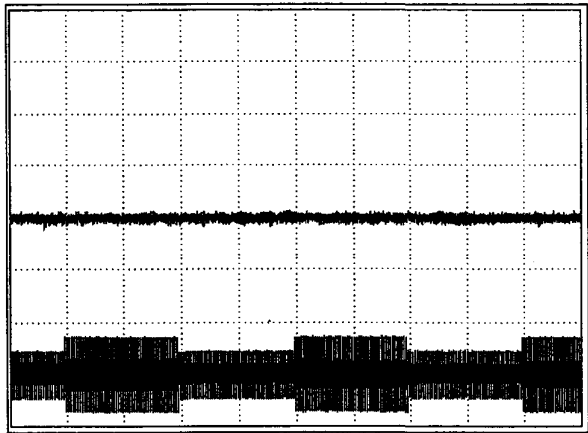

← Vout
← Vin

50mV/DIV | 500mS / DIV

GEN60-25

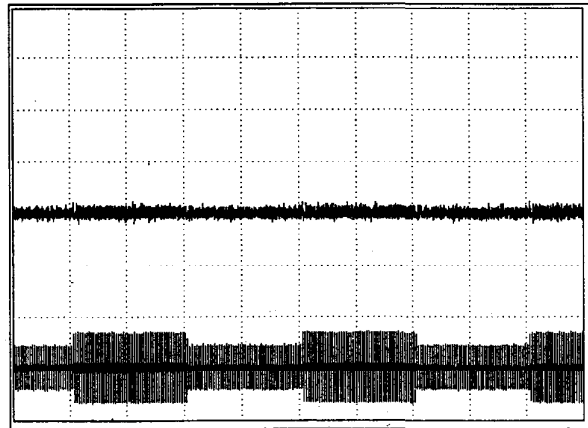

← Vout
← Vin

50mV/DIV | 500mS / DIV

Dynamic Line Response
Constant Voltage Mode

GEN1500

Conditions : Vout:100%
Iout:100%
Vin: 85 \longleftrightarrow 132 VAC
Ta : 25°C

GEN100-15

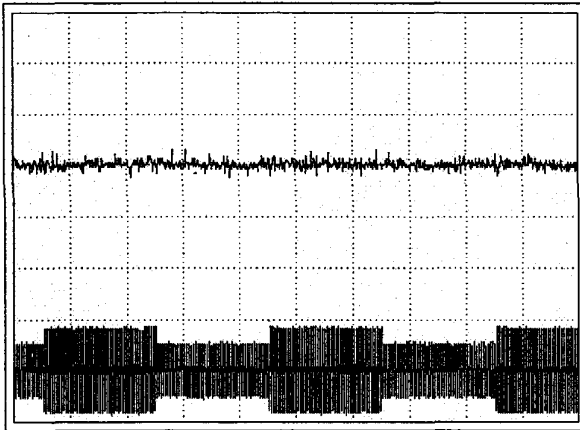

← Vout

← Vin

50mV/DIV 500mS / DIV

GEN600-2.6

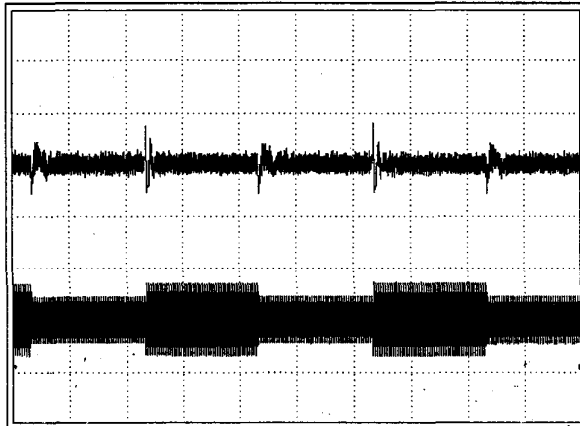

← Vout

← Vin

100mV/DIV 500mS / DIV

Dynamic Line Response
Constant Voltage Mode

GEN1500

Conditions : Vout:100%
Iout:100%
Vin:170 \longleftrightarrow 265VAC
Ta : 25°C

GEN6-200

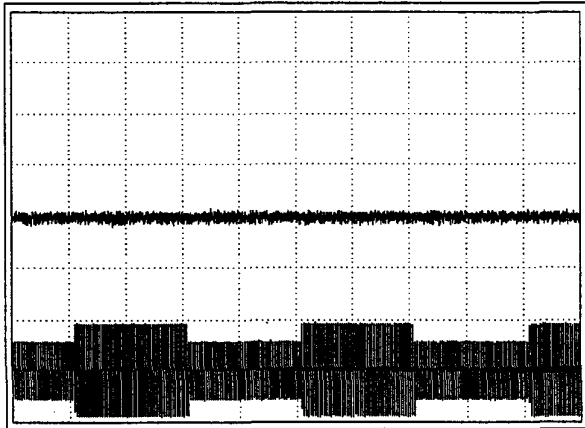

← Vout

← Vin

50mV/DIV | 500mS / DIV

GEN60-25

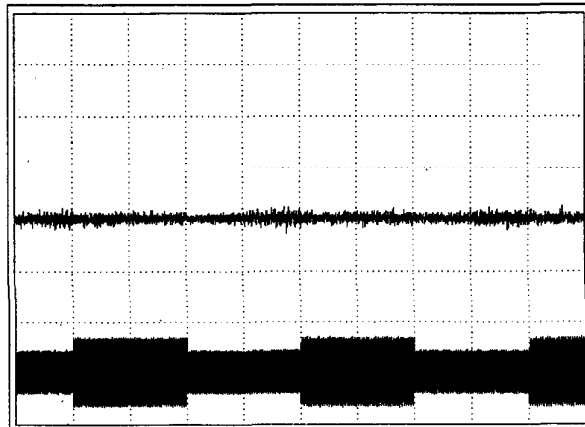

← Vout

← Vin

50mV/DIV | 500mS / DIV

Dynamic Line Response
Constant Voltage Mode

GEN1500

Conditions : $V_{out}: 100\%$
 $I_{out}: 100\%$
 $V_{in}: 170 \rightleftarrows 265VAC$
 $T_a : 25^\circ C$

GEN100-15

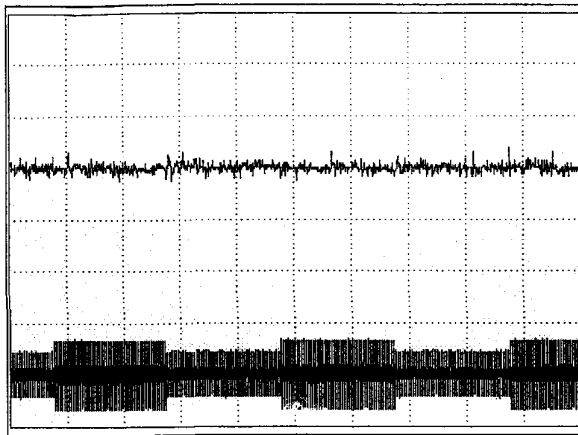

← Vout

← Vin

50mV/DIV 500mS / DIV

GEN600-2.6

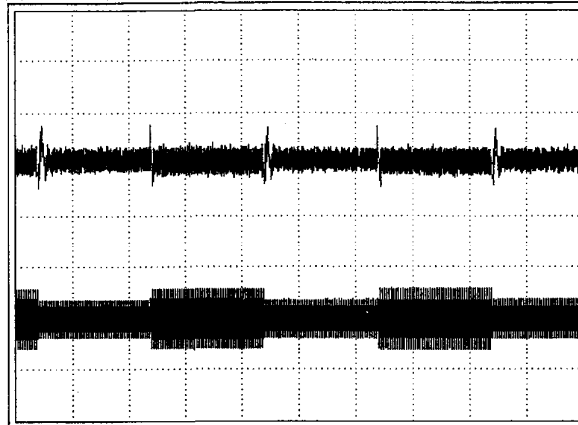

← Vout

← Vin

100mV/DIV 500mS / DIV

Dynamic Line Response
Constant Current Mode

GEN1500

Conditions : Iout:100%
Vout:90%
Vin: 85 \longleftrightarrow 132 VAC
Ta : 25°C

GEN6-200

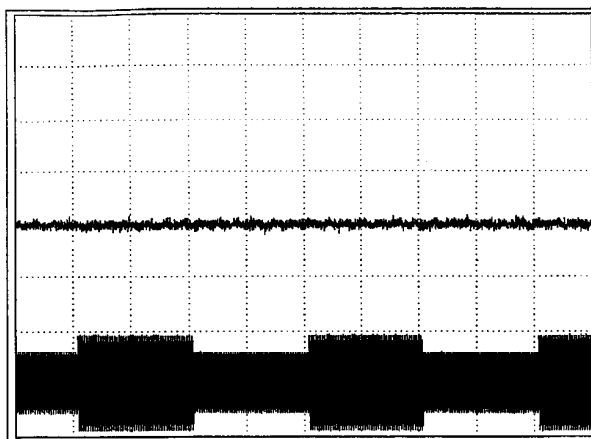

← Iout

← Vin

10A/DIV | 500mS / DIV

GEN60-25

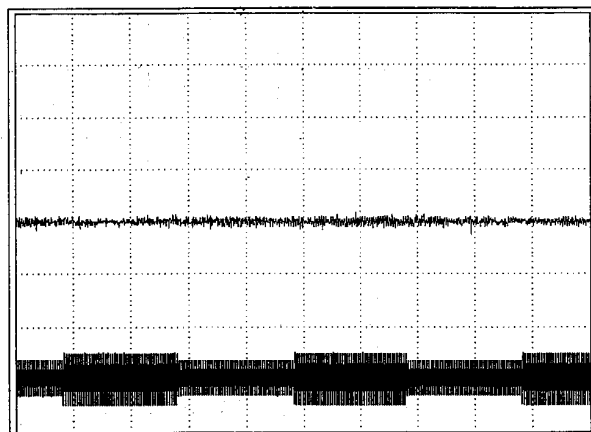

← Iout

← Vin

1A/DIV | 500mS / DIV

Dynamic Line Response
Constant Current Mode

GEN1500

Conditions : Iout:100%
Vout:90%
Vin: 85 \longleftrightarrow 132 VAC
Ta : 25°C

GEN100-15

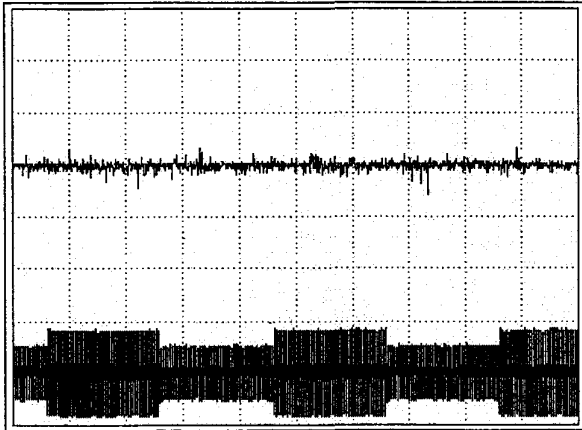

← Iout

← Vin

200mA/DIV 500ms / DIV

GEN600-2.6

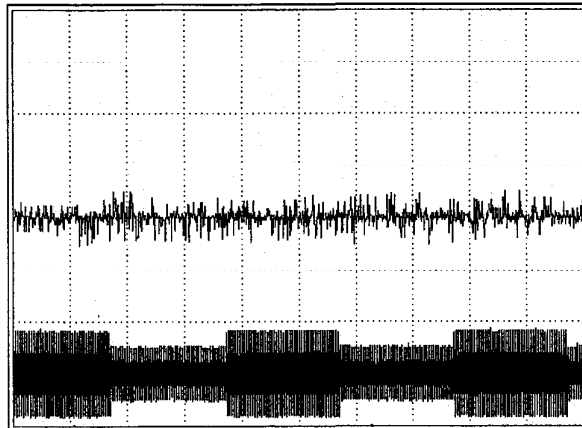

← Iout

← Vin

50mA/DIV 500ms / DIV

Dynamic Line Response
Constant Current Mode

GEN1500

Conditions : I_{out}:100%
V_{out}:90%
V_{in}:170 \longleftrightarrow 265 VAC
T_a : 25°C

GEN6-200

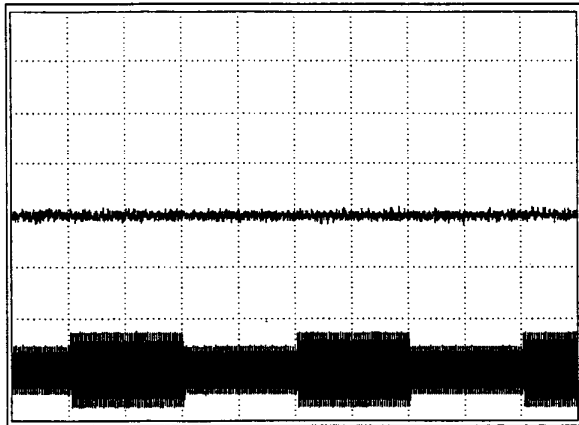

← I_{out}

← V_{in}

10A/DIV 500mS / DIV

GEN60-25

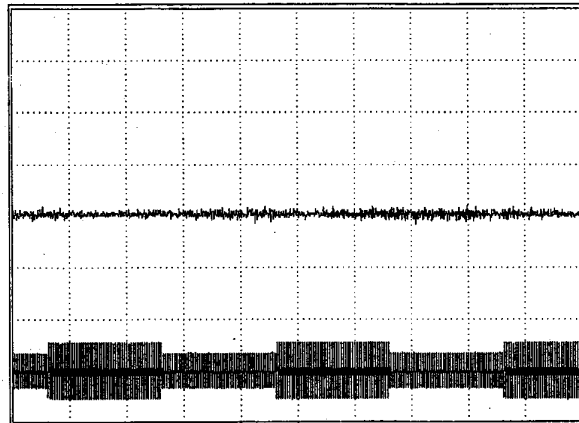

← I_{out}

← V_{in}

1A/DIV 500mS / DIV

Dynamic Line Response
Constant Current Mode

GEN1500

Conditions : Iout:100%
Vout:90%
Vin:170 \longleftrightarrow 265 VAC
Ta : 25°C

GEN100-15

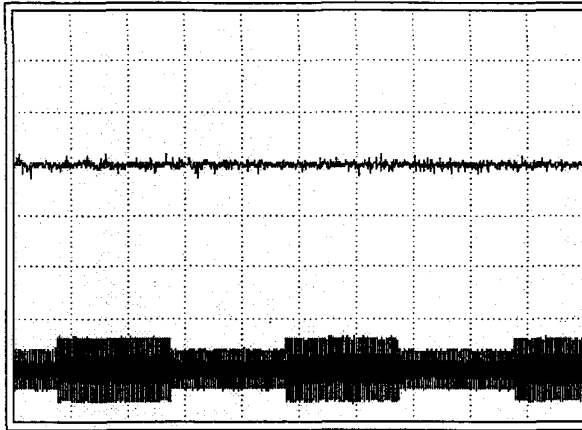

← Iout

← Vin

200mA/DIV 500mS / DIV

GEN600-2.6

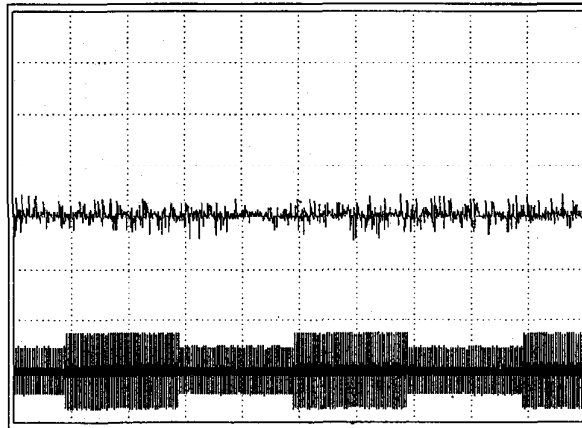

← Iout

← Vin

50mA/DIV 500mS / DIV

2-8. Dynamic Load Response Characteristics
Constant Voltage Mode

GEN1500

Conditions : V_{in} : 100VAC
 V_{out} : 100%
 Load current $t_r = t_f = 100\mu s$
 T_a : 25°C

GEN6-200

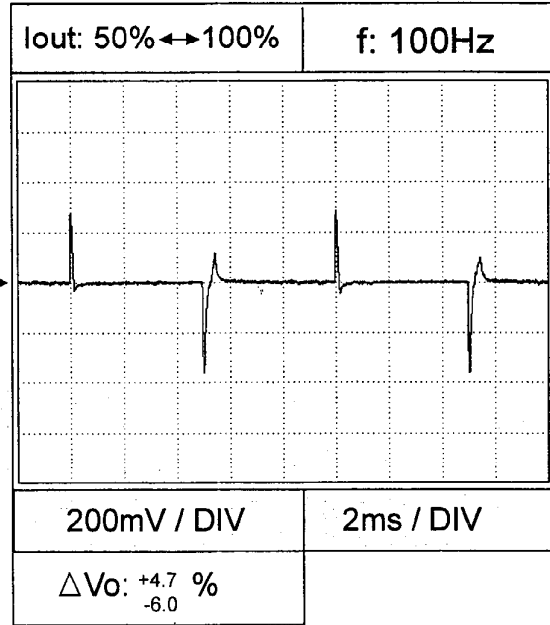
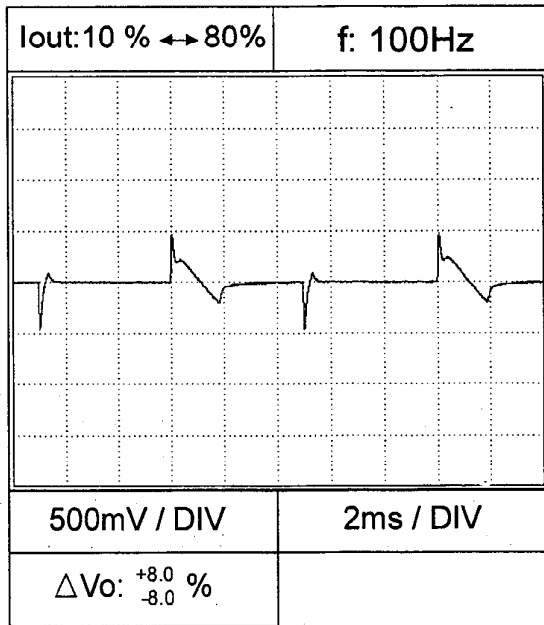

Vout

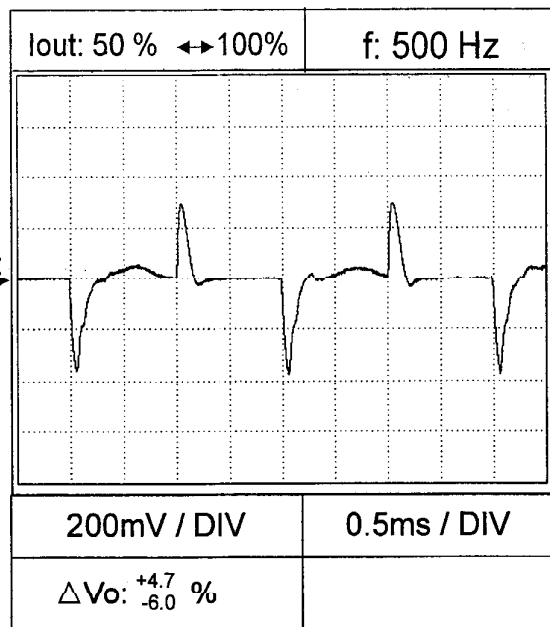
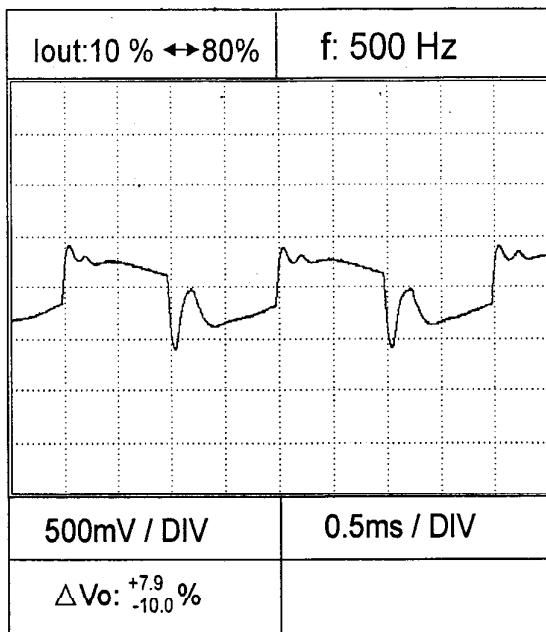

Vout

Dynamic Load Response Characteristics
Constant Voltage Mode

GEN1500

Conditions : V_{in} : 100VAC
 V_{out} : 100%
 Load current $t_r = t_f = 100\mu s$
 T_a : 25°C

GEN60-25

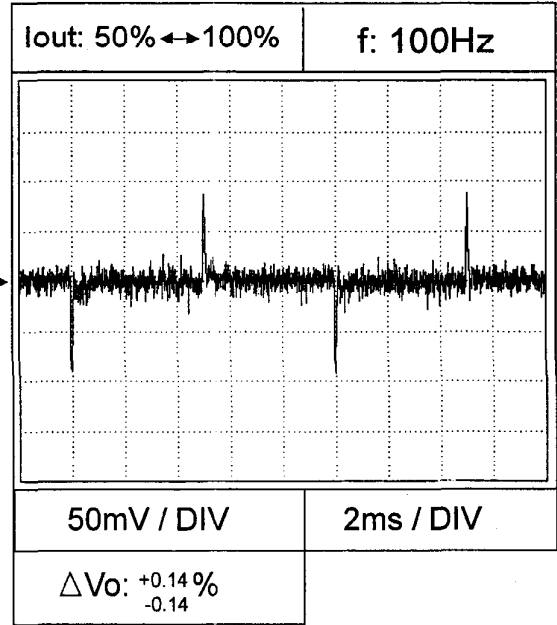
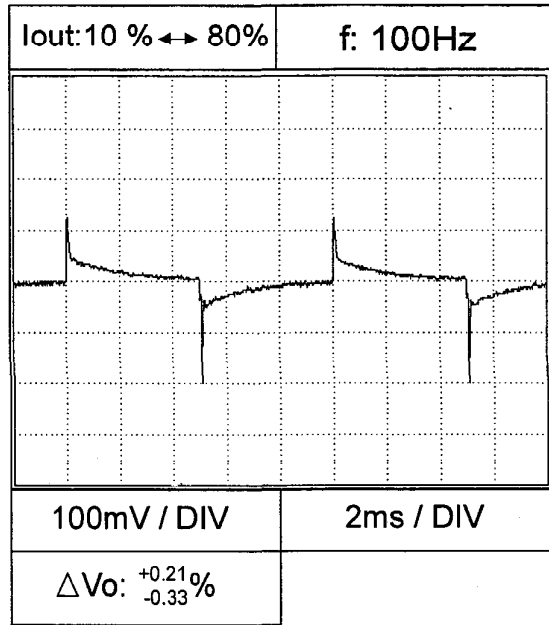

Vout

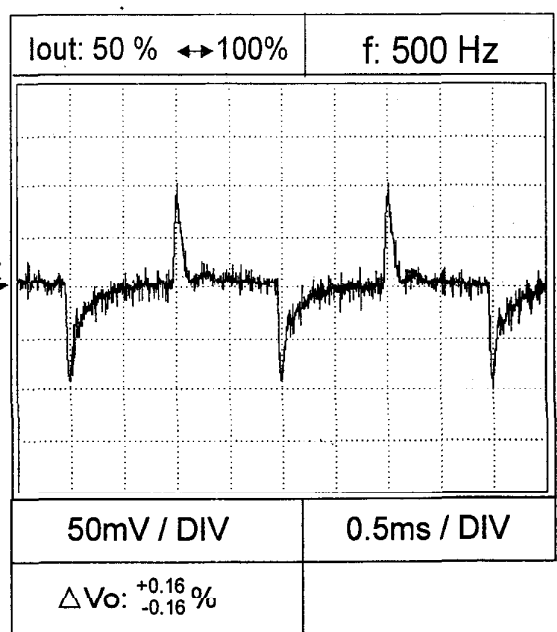
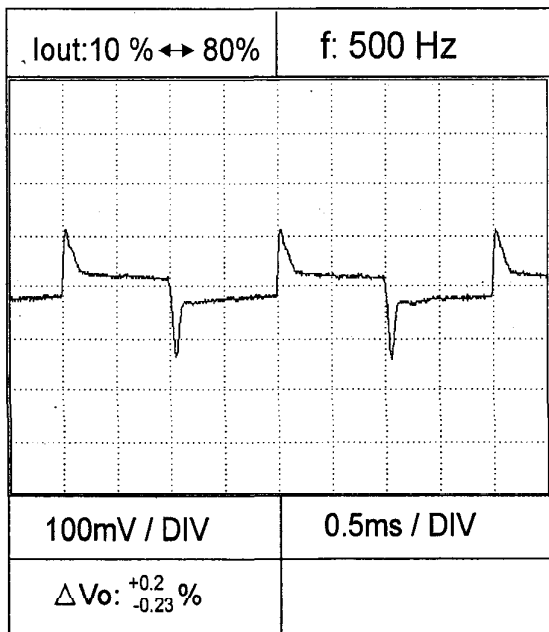

Vout

Dynamic Load Response Characteristics
Constant Voltage Mode

GEN1500

Conditions : V_{in} : 100VAC
 V_{out} : 100%
 Load current $t_r = t_f = 100\mu s$
 T_a : 25°C

GEN100-15

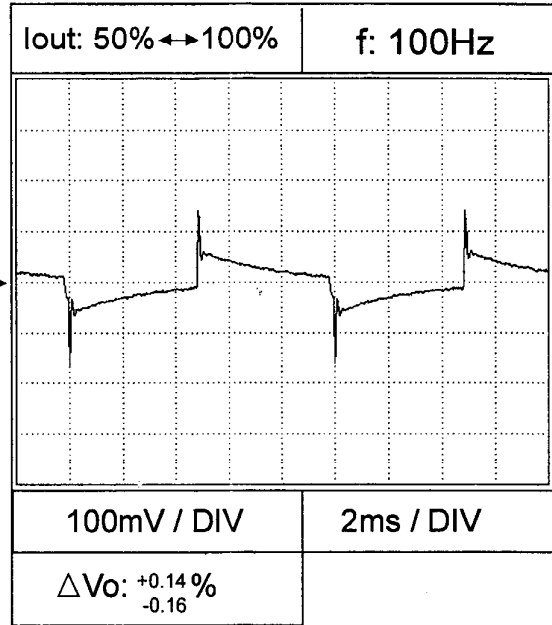
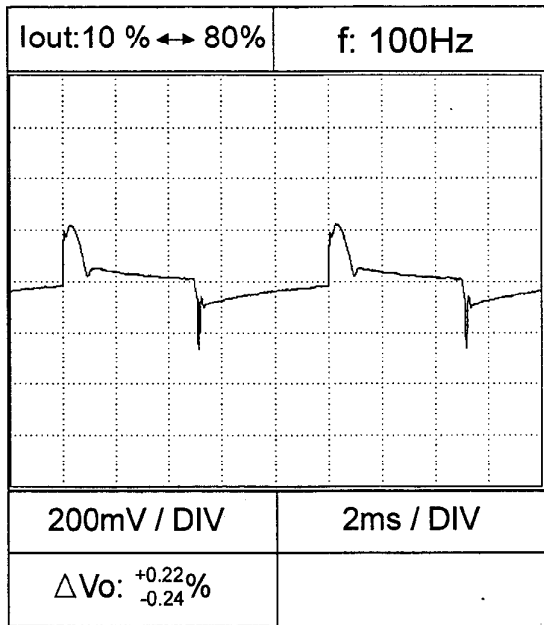

Vout

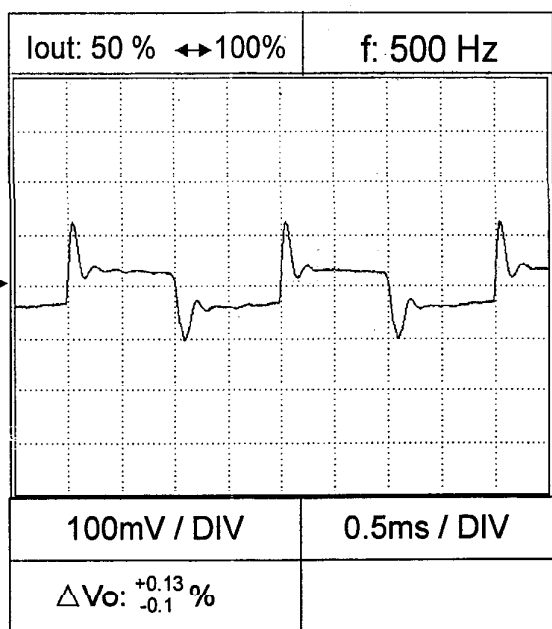
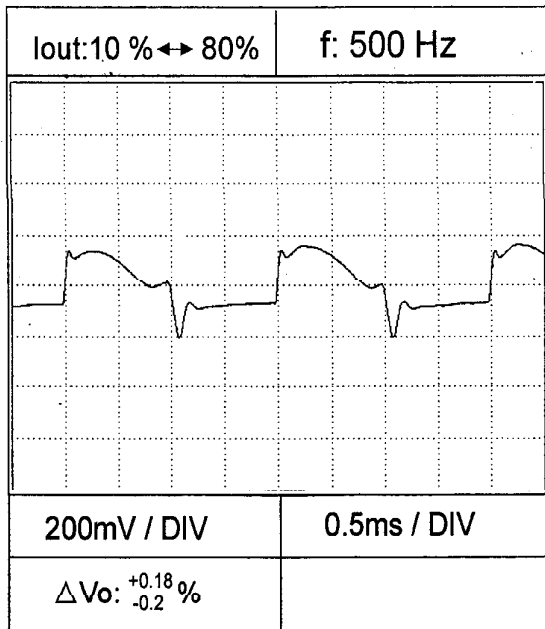

Vout

Dynamic Load Response Characteristics
Constant Voltage Mode

GEN1500

Conditions : V_{in} : 100VAC
 V_{out} : 100%
 Load current $t_r = t_f = 100\mu s$
 T_a : 25°C

GEN600-2.6

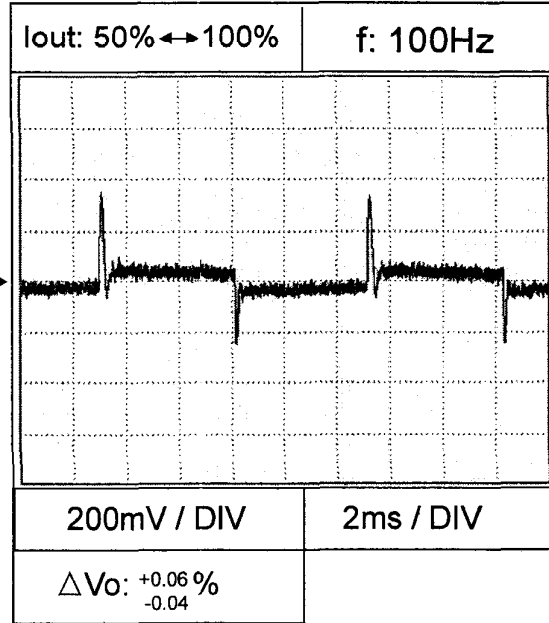
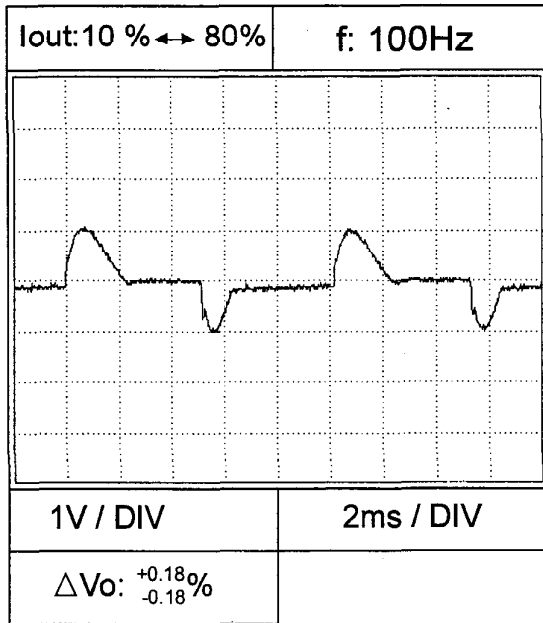

Vout

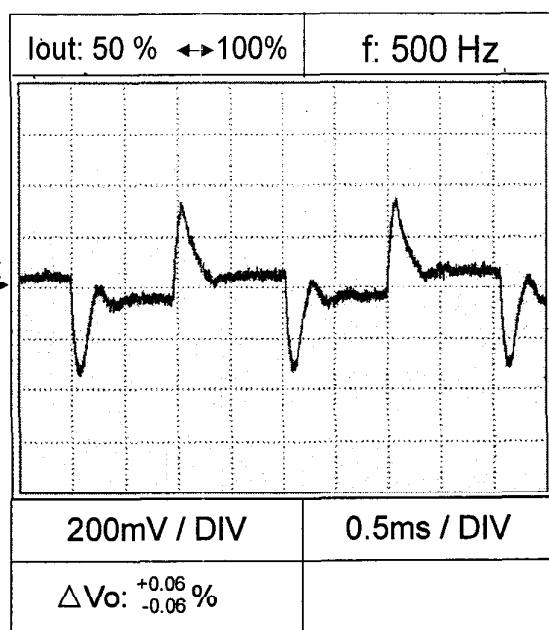
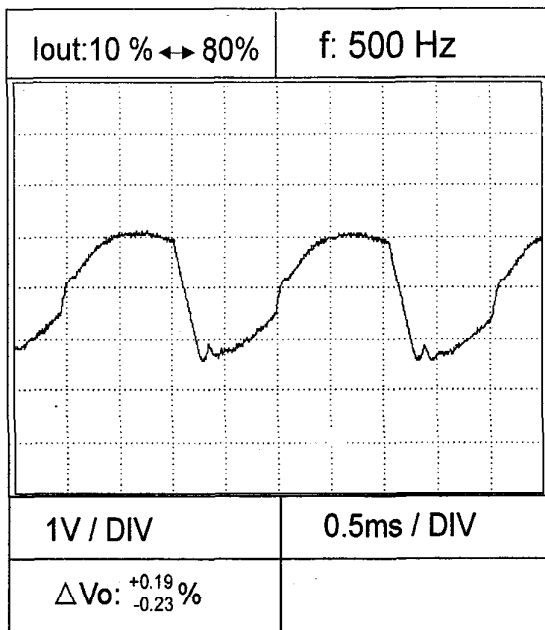

Vout

Dynamic Load Response Characteristics
Constant Current Mode

GEN1500

Conditions : $V_{in} : 100VAC$

Load current $t_r = t_f = 100\mu s$
 $T_a : 25^\circ C$

GEN6-200

$I_{out} : 180A$

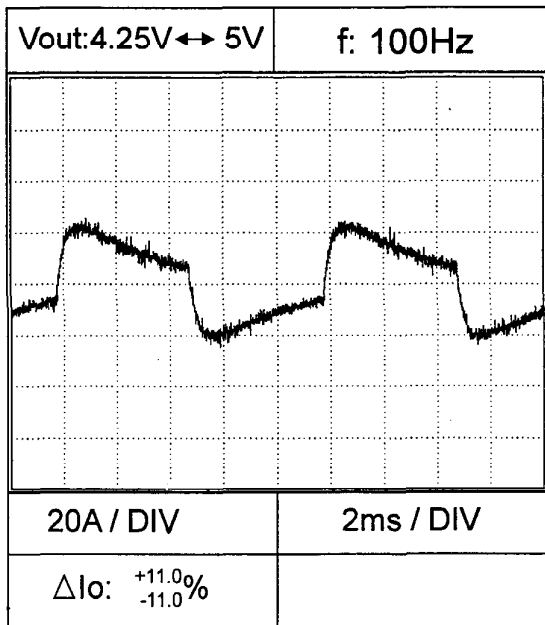

$I_{out} : 100A$

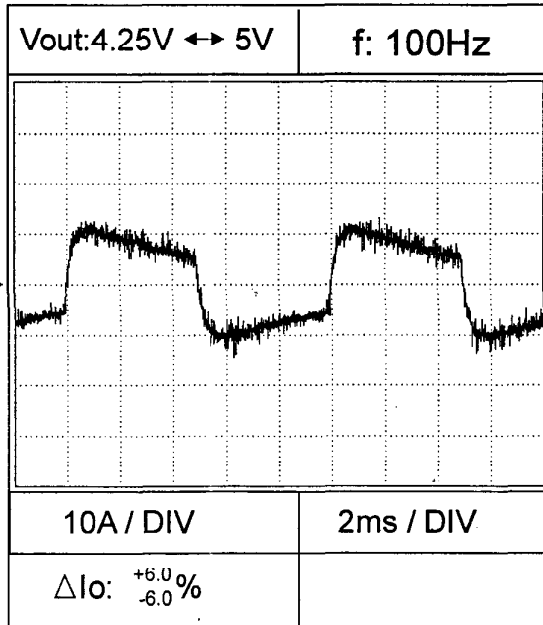

I_{out}

$I_{out} : 180A$

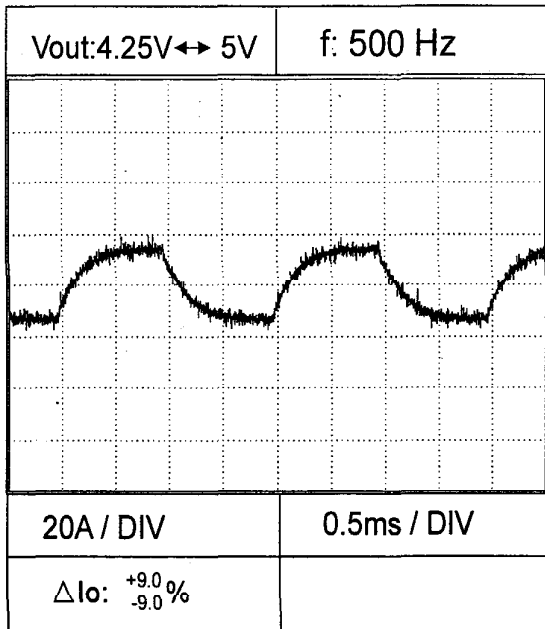

$I_{out} : 100A$

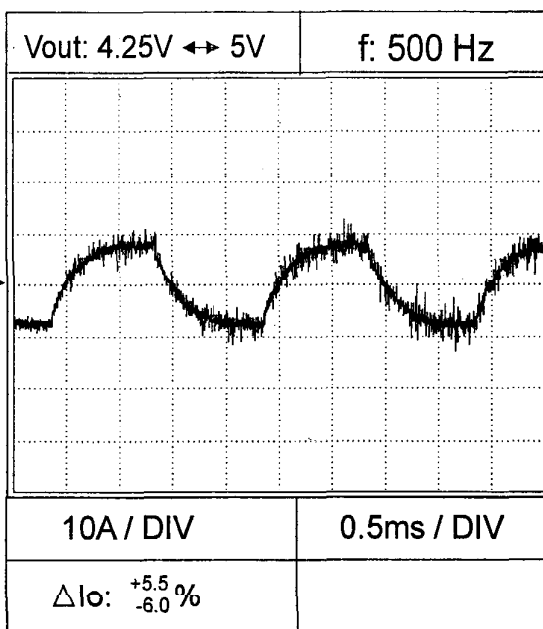

I_{out}

Dynamic Load Response Characteristics
Constant Current Mode

GEN1500

Conditions : $V_{in} : 100VAC$

Load current $t_r = t_f = 100\mu s$

$T_a : 25^\circ C$

GEN60-25

$I_{out} : 25A$

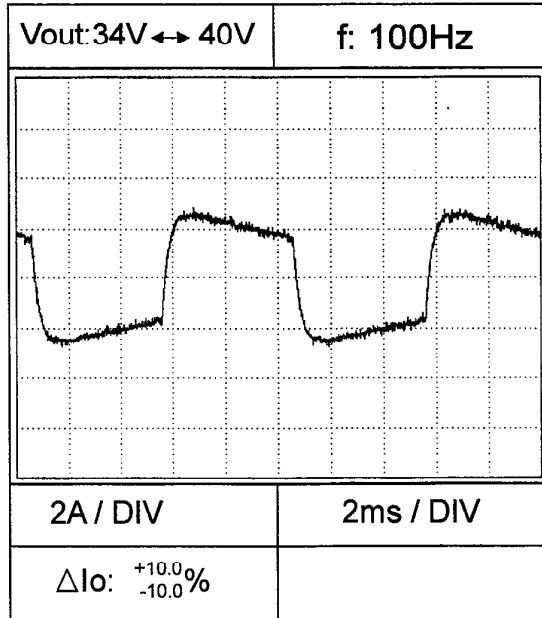

$I_{out} : 12.5A$

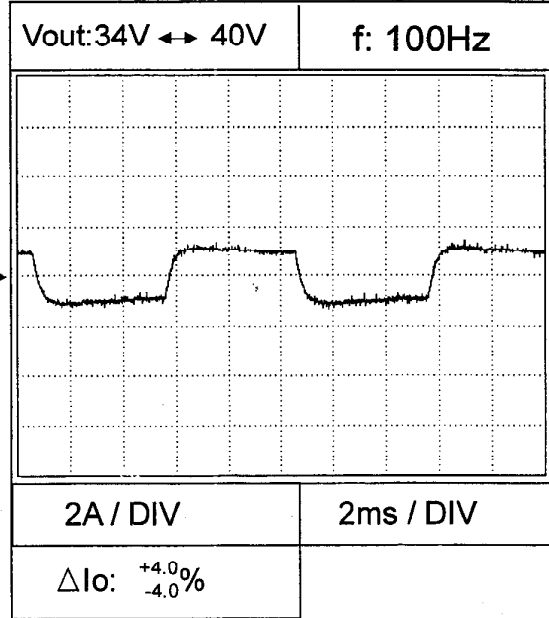

$I_{out} : 25A$

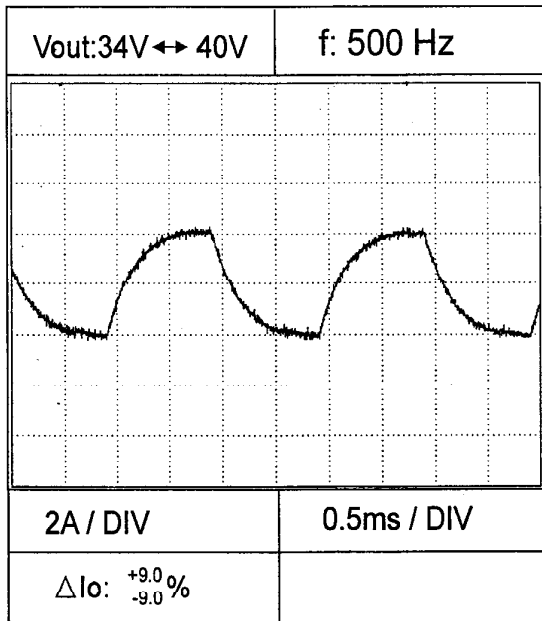

$I_{out} : 12.5A$

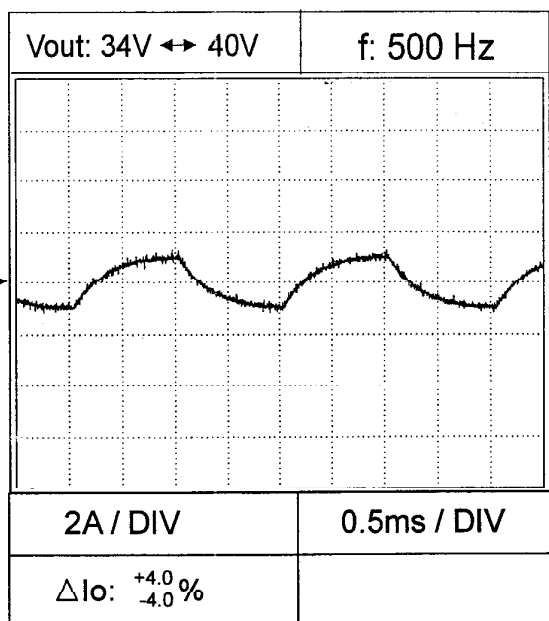

Dynamic Load Response Characteristics
Constant Current Mode

GEN1500

Conditions : $V_{in} : 100VAC$

Load current $t_r = t_f = 100\mu s$

$T_a : 25^{\circ}C$

GEN100-15

$I_{out} : 15A$

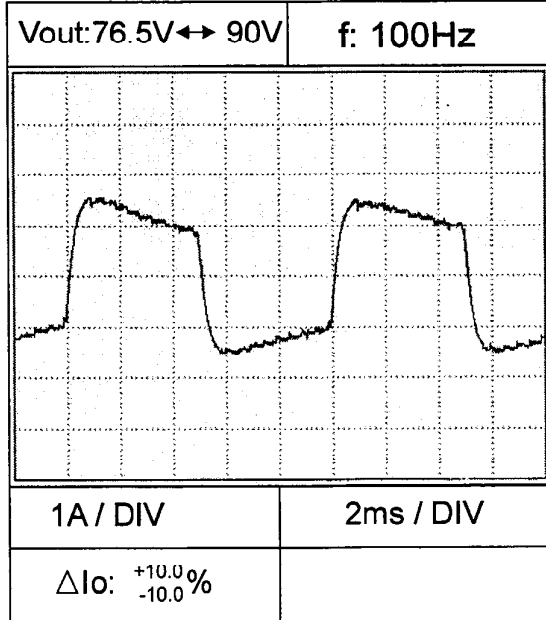

I_{out}

$I_{out} : 7.5A$

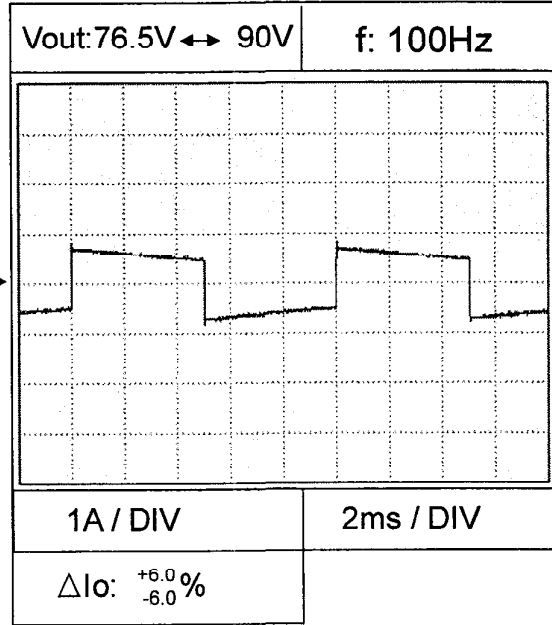

$I_{out} : 15A$

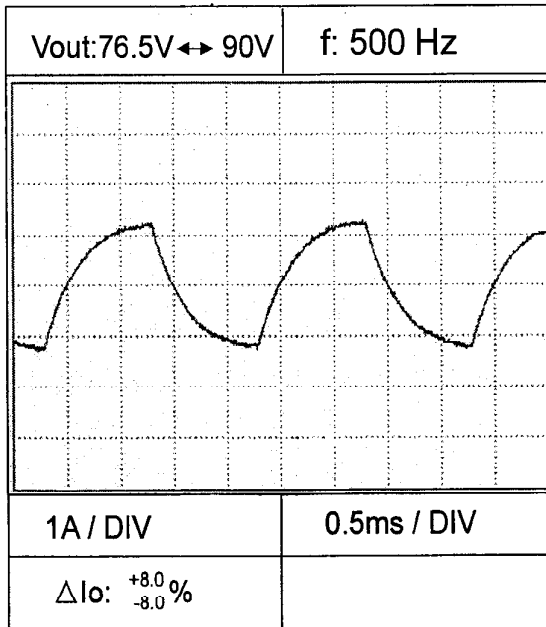

I_{out}

$I_{out} : 7.5A$

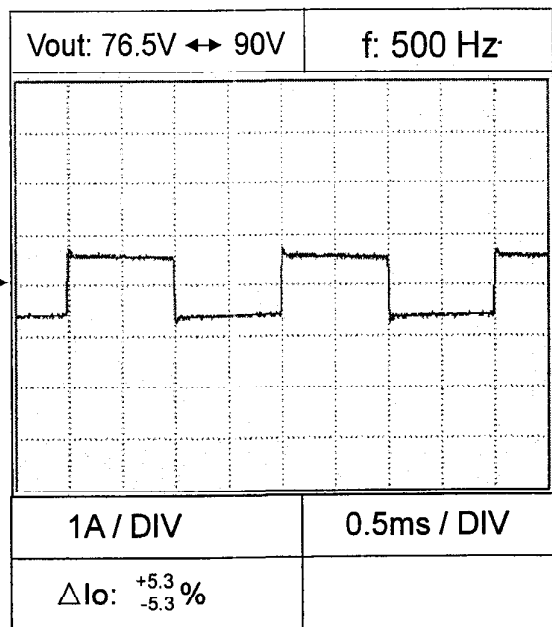

Dynamic Load Response Characteristics
Constant Current Mode

GEN1500

Conditions : $V_{in} : 100VAC$

Load current $t_r = t_f = 100\mu s$
 $T_a : 25^\circ C$

GEN600-2.6

$I_{out} : 2.6A$

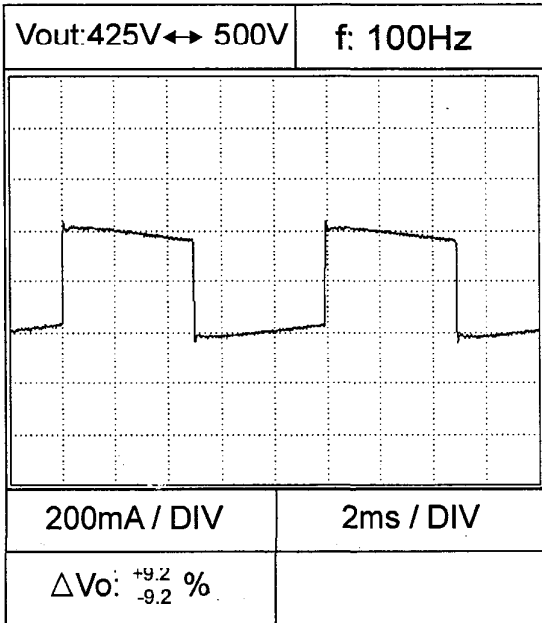

I_{out}

$I_{out} : 1.3A$

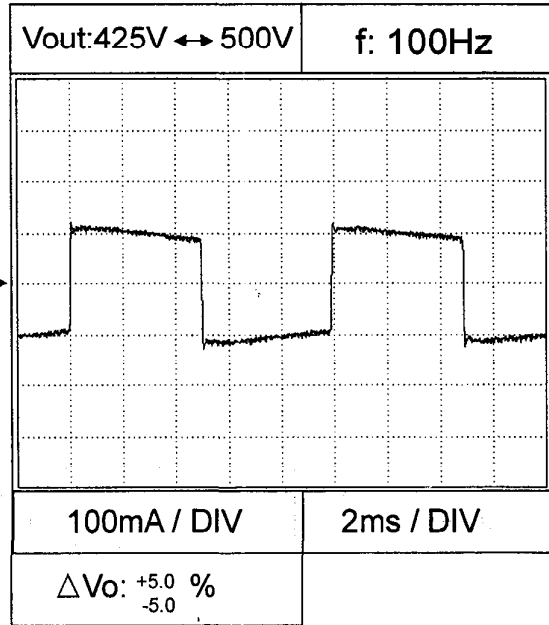

$I_{out} : 2.6A$

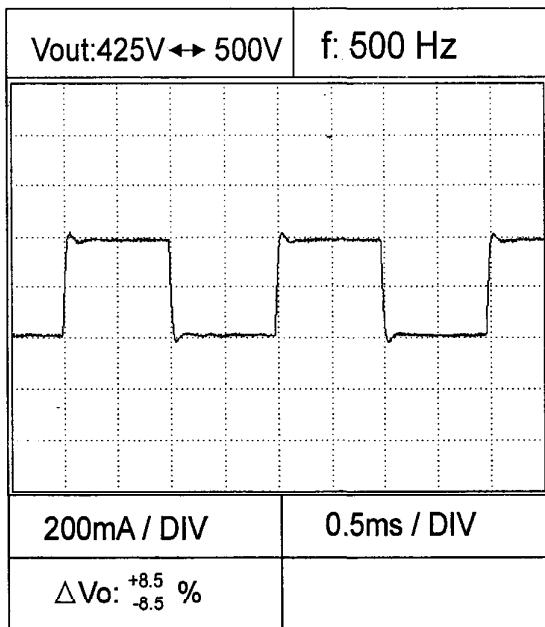

I_{out}

$I_{out} : 1.3A$

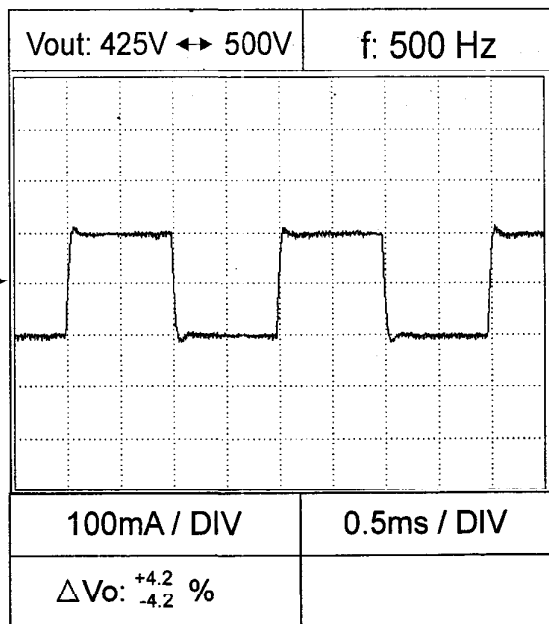

2-9. Response to Brown-out Characteristics
Constant Voltage Mode

GEN1500

Conditions Vin: 100VAC
Vout: 100%
Iout: 100%
Ta: 25°C

GEN6-200

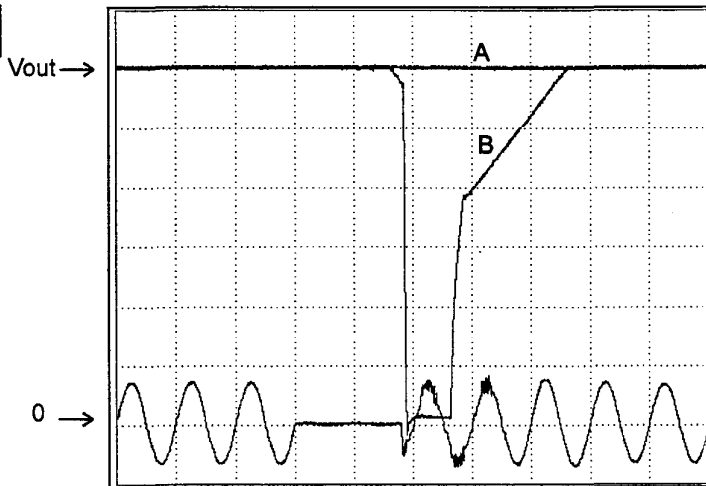

Brown-out Time
A-26mS
B-36mS

1V/DIV 20ms/DIV

GEN60-25

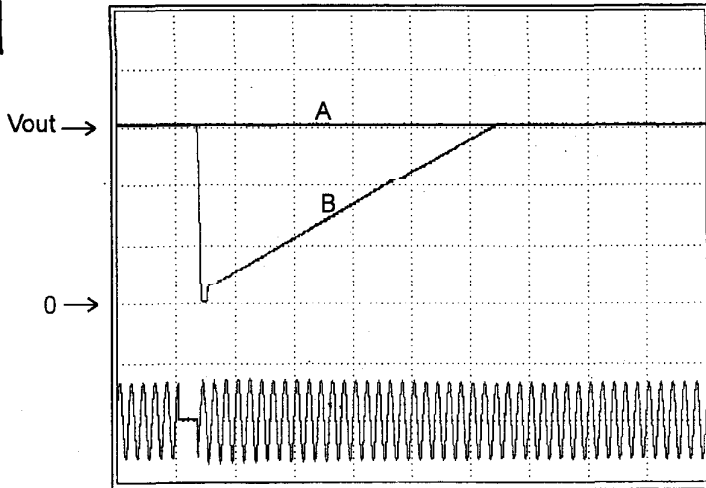

Brown-out Time
A-29mS
B-31mS

20V/DIV 100ms/DIV

Response to Brown-out Characteristics
Constant Voltage Mode

GEN1500

Conditions Vin: 200VAC
Vout: 100%
Iout: 100%
Ta: 25°C

GEN6-200

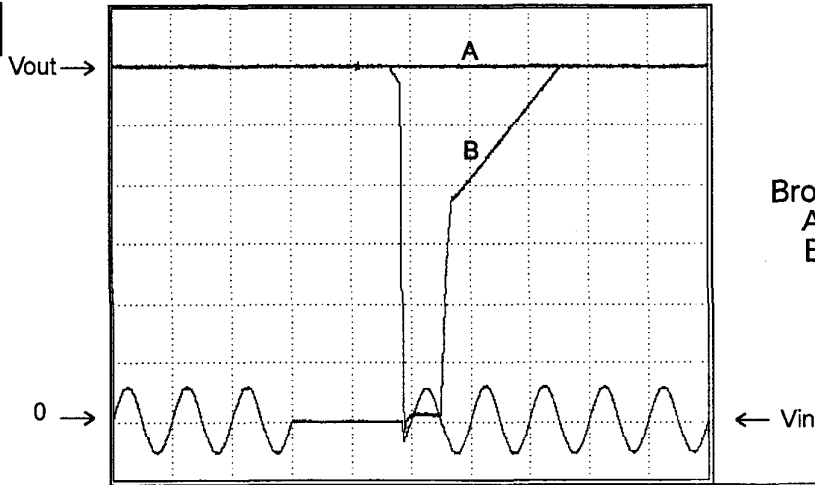

Brown-out Time
A-20mS
B-37mS

1V/DIV 20ms/DIV

GEN60-25

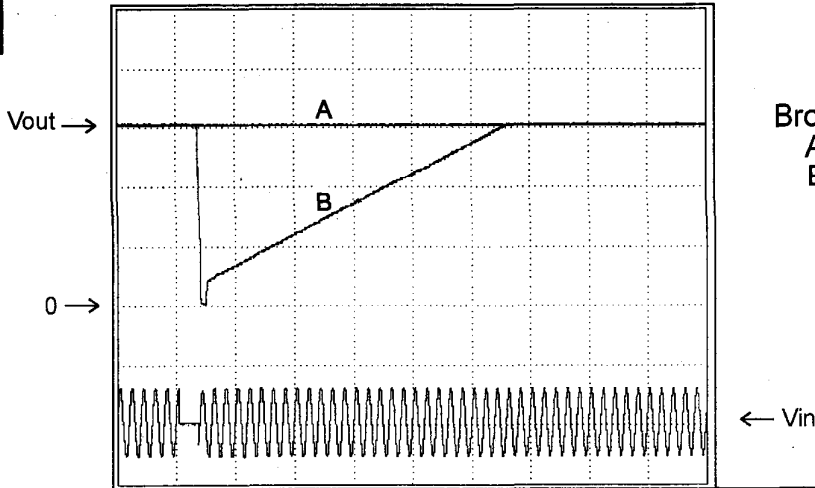

Brown-out Time
A-30mS
B-32mS

20V/DIV 100ms/DIV

Response to Brown-out Characteristics
Constant Voltage Mode

GEN1500

Conditions V_{in} : 100VAC
 V_{out} : 100%
 I_{out} : 100%
 T_a : 25°C

GEN100-15

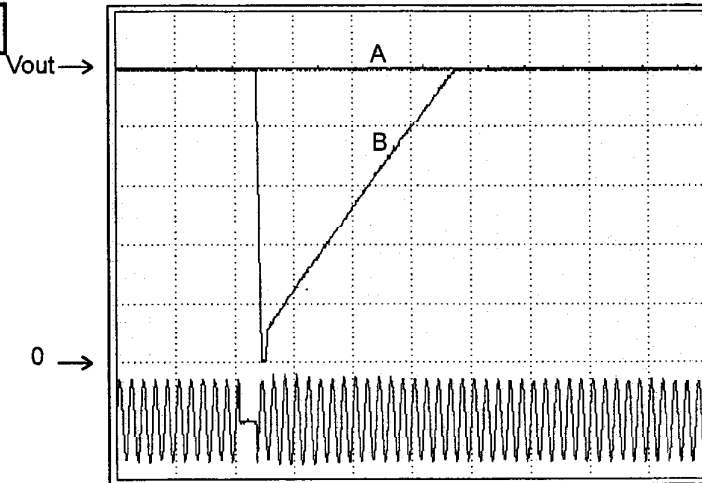

Brown-out Time
A-29mS
B-31mS

20V/DIV | 100ms/DIV

GEN600-2.6

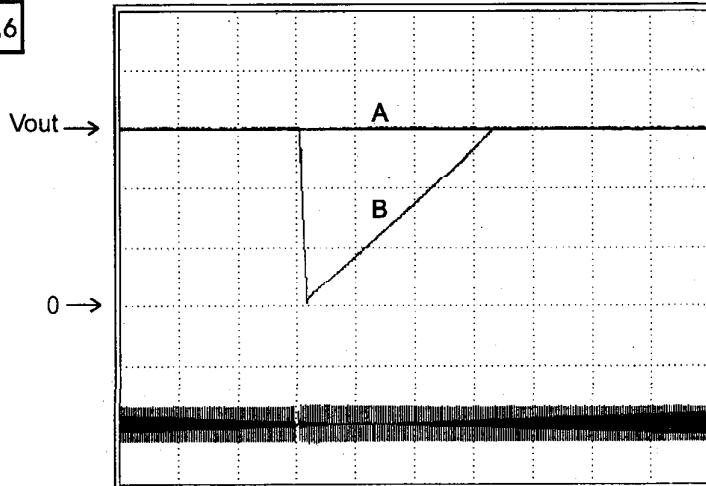

Brown-out Time
A-25mS
B-67mS

200V/DIV | 500ms/DIV

Response to Brown-out Characteristics
Constant Voltage Mode

GEN1500

Conditions V_{in} : 200VAC
 V_{out} : 100%
 I_{out} : 100%
 T_a : 25°C

GEN100-15

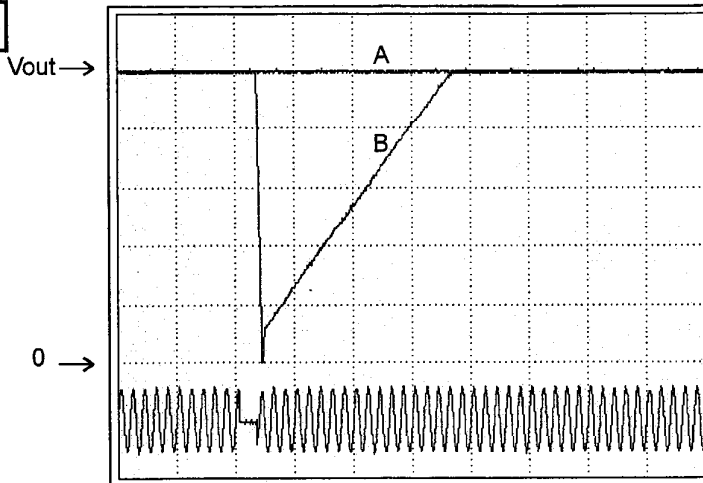

Brown-out Time
A-30mS
B-32mS

20V/DIV | 100ms/DIV

GEN600-2.6

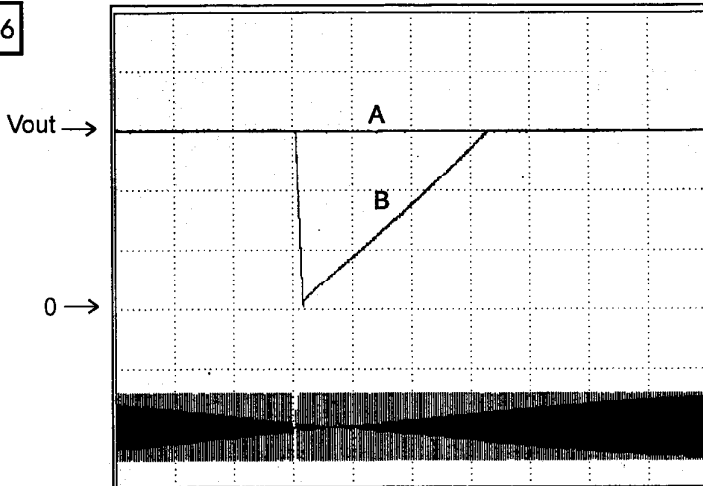

Brown-out Time
A-27mS
B-67mS

200V/DIV | 500ms/DIV

2 -10. Inrush Current Characteristic

GEN1500

Conditions: Vout: 100%
Iout: 0% -----
Iout: 100% ————
Vin : 100VAC
Ta : 25°C

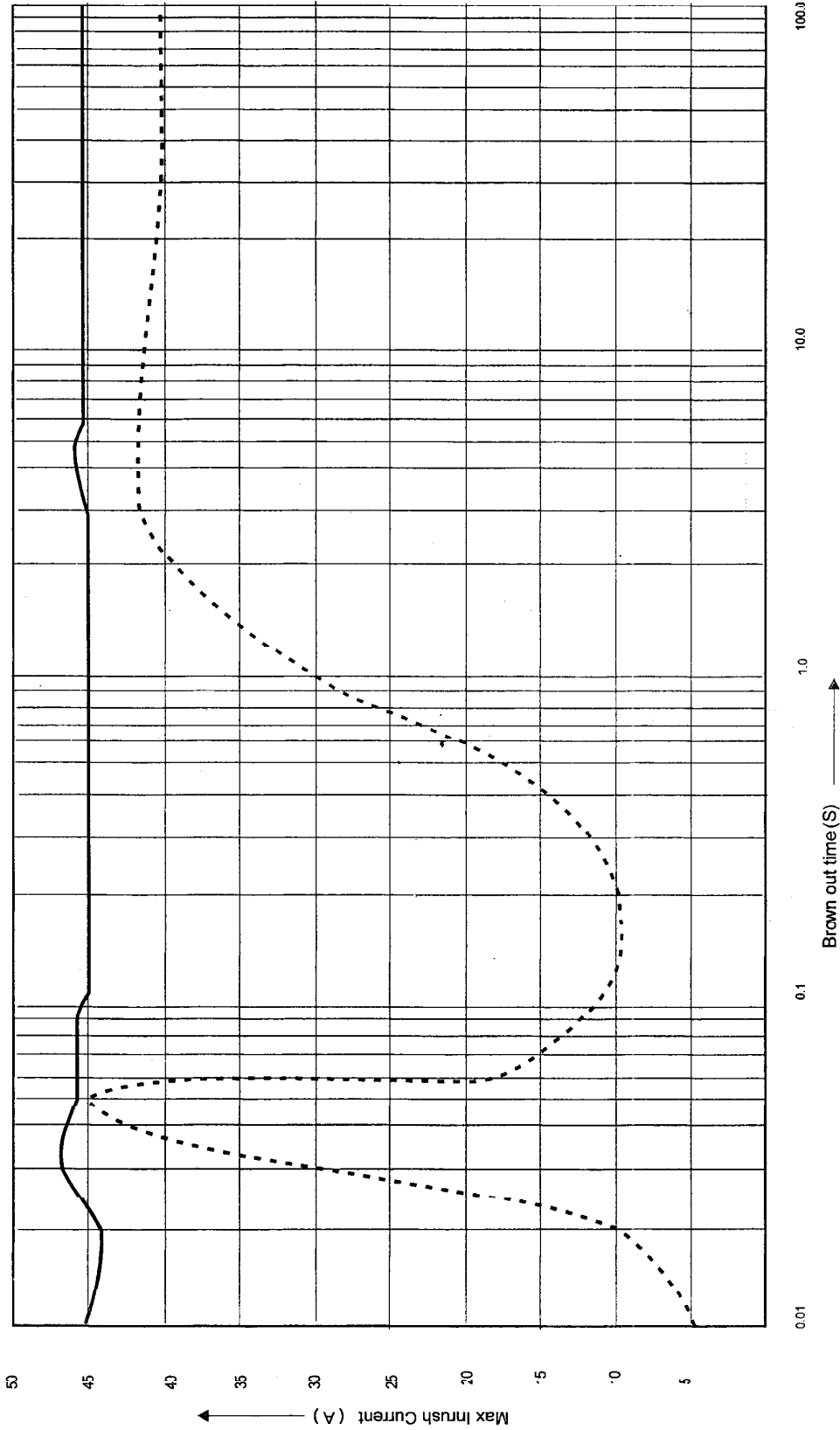

NEMIC-LAMBDA

T-62

Inrush Current Characteristic

GEN1500

Conditions: Vout: 100%
Iout: 0% -----
Iout: 100% ———
Vin : 200VAC
Ta : 25°C

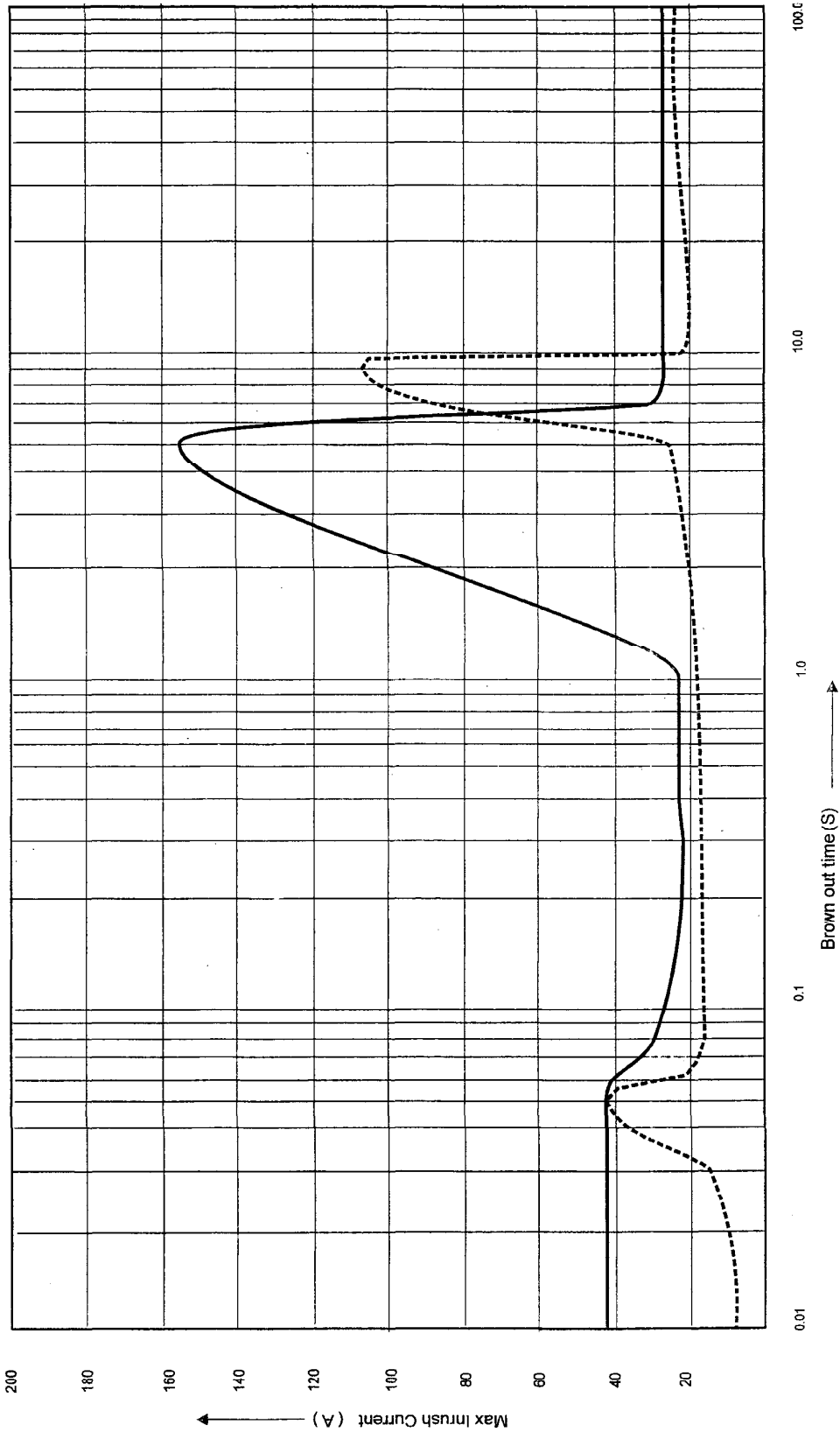

NEMIC-LAMBDA

T-63

2-11. Inrush Current Waveform

GEN1500

Conditions: V_{in} : 100VAC
 V_{out} : 100%
 I_{out} : 100 %
 T_a : 25°C

GEN6-200

SWITCH ON PHASE
ANGLE OF INPUT
AC VOLTAGE

$$\phi = 0^\circ$$

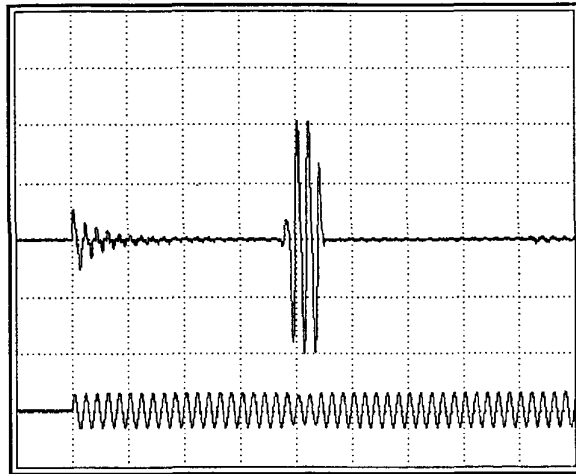

← I_{in}

← V_{in}

20A/DIV 100ms/DIV

GEN6-200

SWITCH ON PHASE
ANGLE OF INPUT
AC VOLTAGE

$$\phi = 90^\circ$$

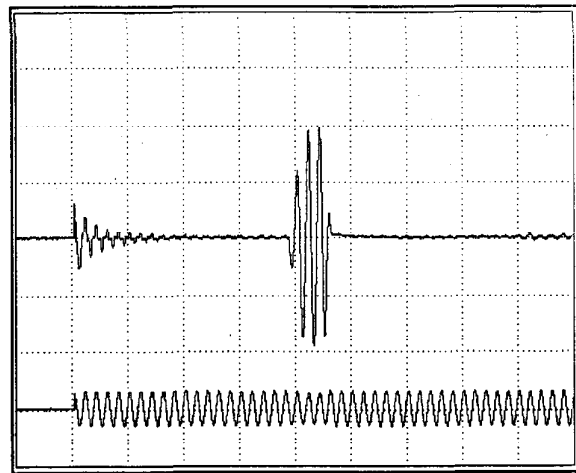

← I_{in}

← V_{in}

20A/DIV 100ms/DIV

Inrush Current Waveform

GEN1500

Conditions: V_{in} : 200VAC
 V_{out} : 100%
 I_{out} : 100 %
 T_a : 25°C

GEN6-200

SWITCH ON PHASE
ANGLE OF INPUT
AC VOLTAGE

$$\phi = 0^\circ$$

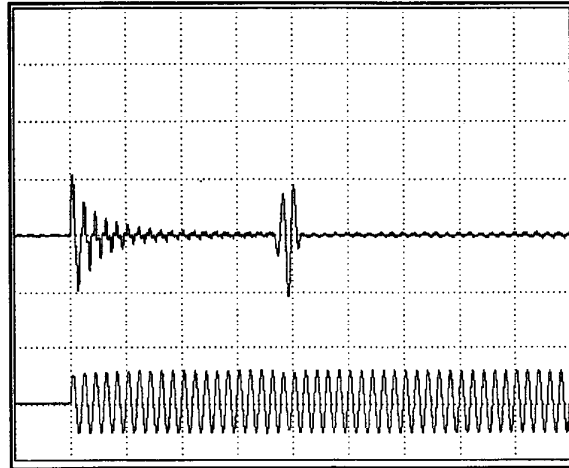

← I_{in}

← V_{in}

20A/DIV | 100ms/DIV

GEN6-200

SWITCH ON PHASE
ANGLE OF INPUT
AC VOLTAGE

$$\phi = 90^\circ$$

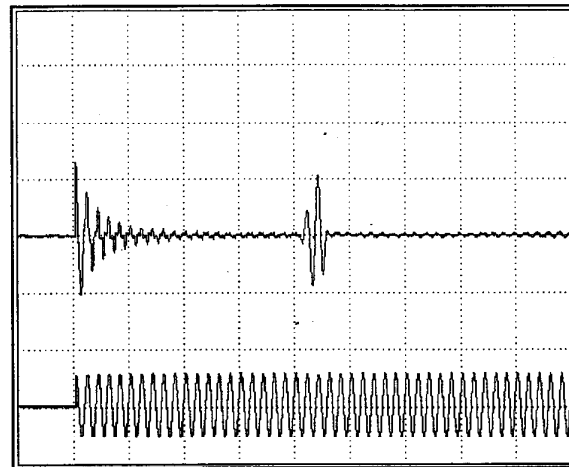

← I_{in}

← V_{in}

20A/DIV | 100ms/DIV

Inrush Current Waveform

GEN1500

Conditions: V_{in} : 100VAC
 V_{out} : 100%
 I_{out} : 100 %
 T_a : 25°C

GEN100-15

SWITCH ON PHASE
ANGLE OF INPUT
AC VOLTAGE

$$\phi = 0^\circ$$

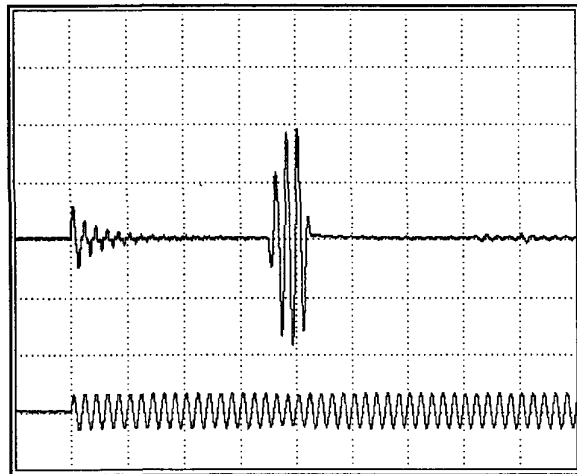

← I_{in}

← V_{in}

20A/DIV | 100ms/DIV

GEN100-15

SWITCH ON PHASE
ANGLE OF INPUT
AC VOLTAGE

$$\phi = 90^\circ$$

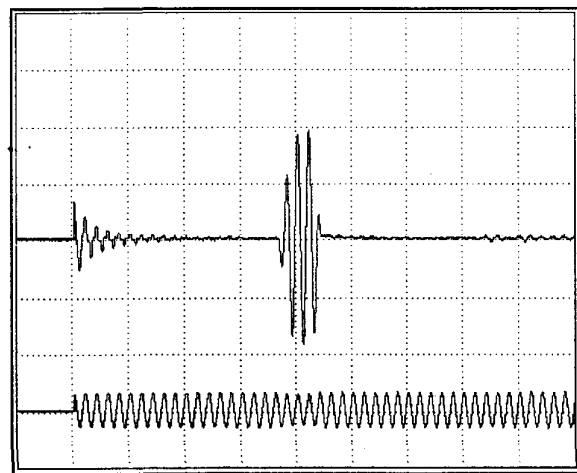

← I_{in}

← V_{in}

20A/DIV | 100ms/DIV

Inrush Current Waveform

GEN1500

Conditions: V_{in} : 200VAC
 V_{out} : 100%
 I_{out} : 100 %
 T_a : 25°C

GEN100-15

SWITCH ON PHASE
ANGLE OF INPUT
AC VOLTAGE

$$\phi = 0^\circ$$

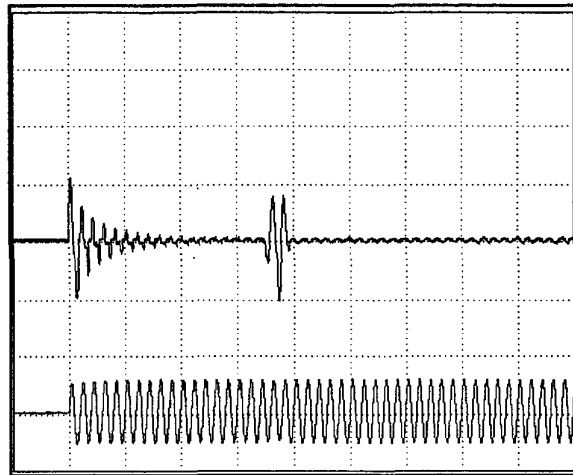

← I_{in}

← V_{in}

20A/DIV | 100ms/DIV

GEN100-15

SWITCH ON PHASE
ANGLE OF INPUT
AC VOLTAGE

$$\phi = 90^\circ$$

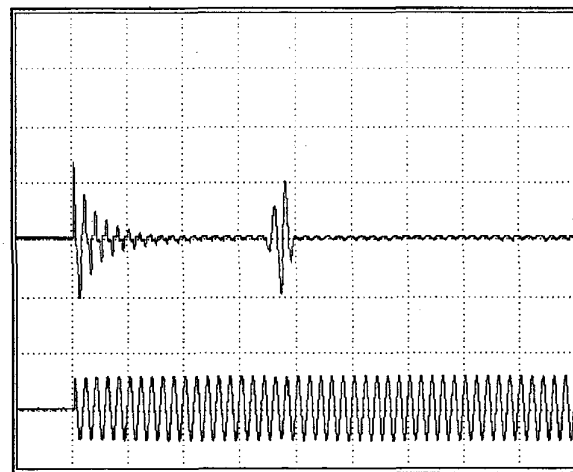

← I_{in}

← V_{in}

20A/DIV | 100ms/DIV

Inrush Current Waveform

GEN1500

Conditions: V_{in} : 100VAC
 V_{out} : 100%
 I_{out} : 100 %
 T_a : 25°C

GEN600-2.6

SWITCH ON PHASE
ANGLE OF INPUT
AC VOLTAGE

$$\phi = 0^\circ$$

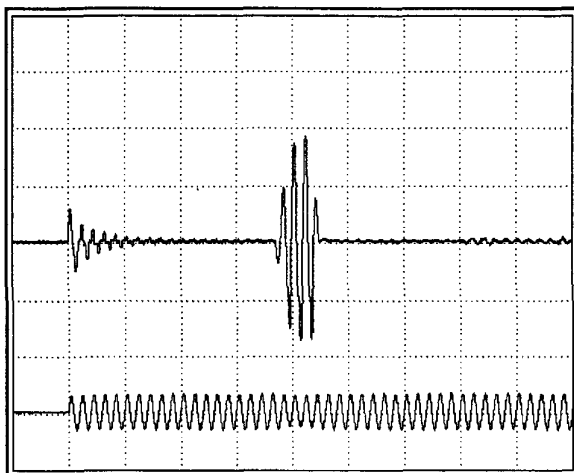

← I_{in}

← V_{in}

20A/DIV | 100ms/DIV

GEN600-2.6

SWITCH ON PHASE
ANGLE OF INPUT
AC VOLTAGE

$$\phi = 90^\circ$$

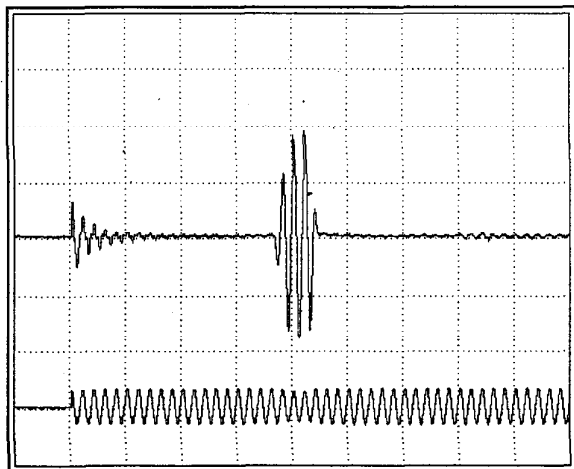

← I_{in}

← V_{in}

20A/DIV | 100ms/DIV

Inrush Current Waveform

GEN1500

Conditions: V_{in} : 200VAC
 V_{out} : 100%
 I_{out} : 100 %
 T_a : 25°C

GEN600-2.6

SWITCH ON PHASE
ANGLE OF INPUT
AC VOLTAGE

$$\phi = 0^\circ$$

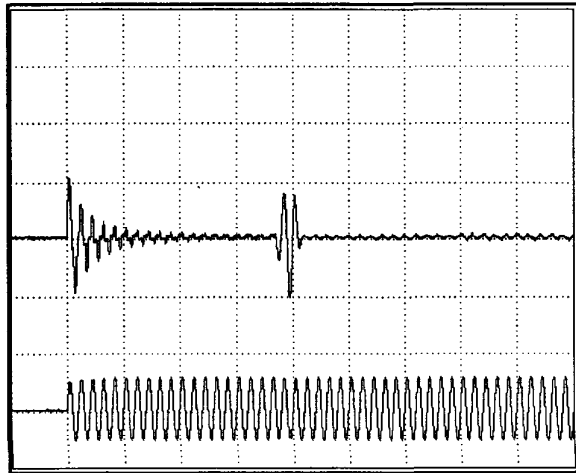

20A/DIV | 100ms/DIV

GEN600-2.6

SWITCH ON PHASE
ANGLE OF INPUT
AC VOLTAGE

$$\phi = 90^\circ$$

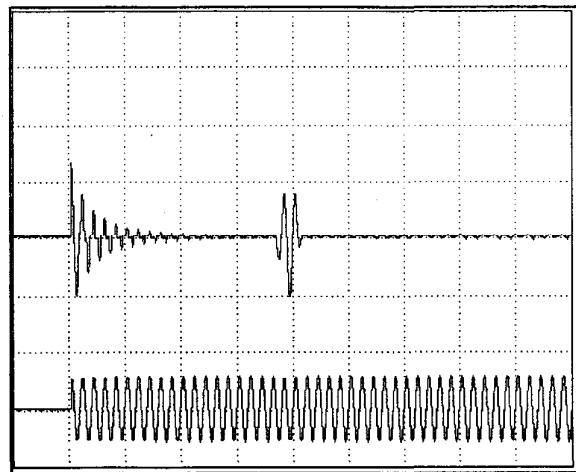

20A/DIV | 100ms/DIV

2-12. Input Current Waveform

GEN1500

Conditions: V_{in} : 100VAC
 V_{out} : 100%
 I_{out} : 100 %
 T_a : 25°C

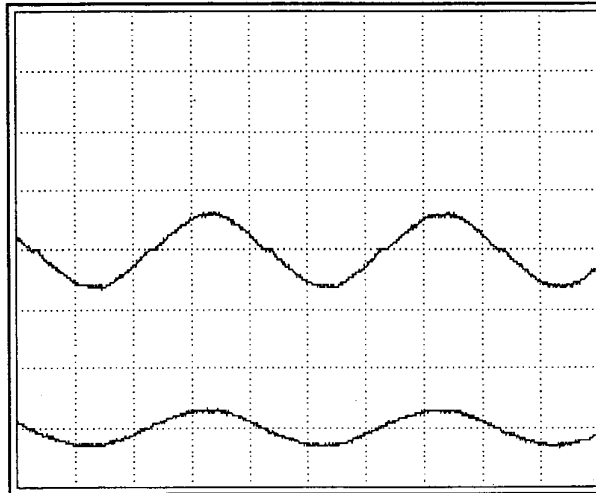

← I_{in}

← V_{in}

40A/DIV 5ms/DIV

Conditions: V_{in} : 200VAC
 V_{out} : 100%
 I_{out} : 100 %
 T_a : 25°C

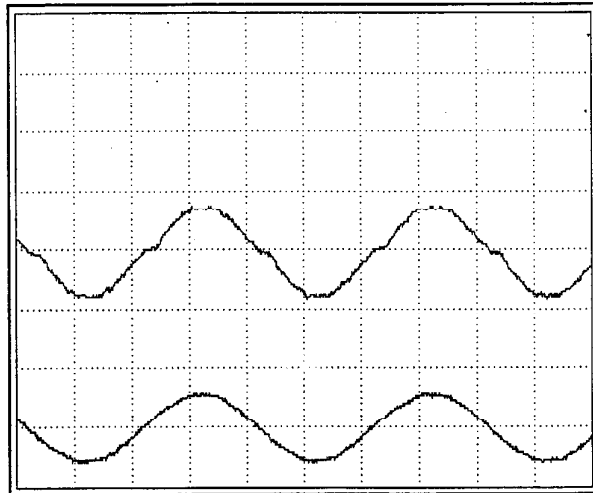

← I_{in}

← V_{in}

15A/DIV 5ms/DIV

2-13. Leakage current characteristics

GEN1500

Conditions: Vout:100%
 Iout: 100% ———
 0% - - - -
 Ta:25°C

LINE-GND.

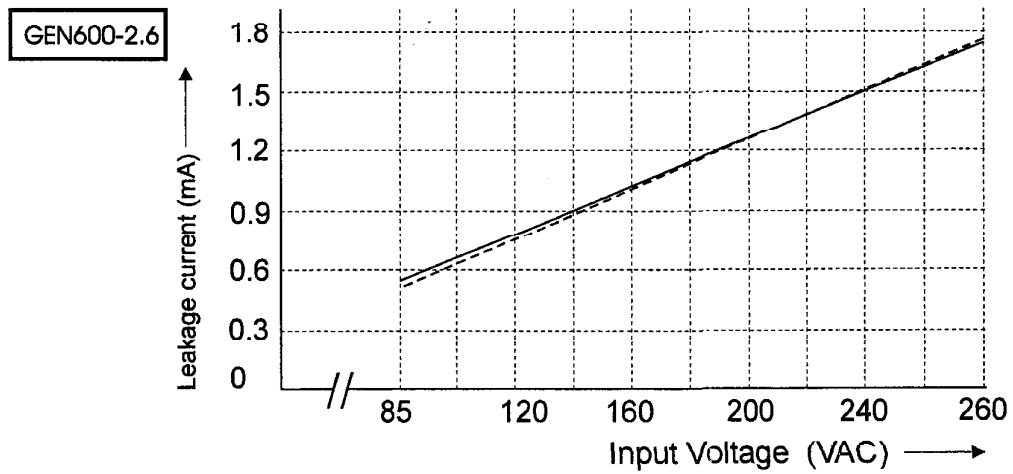
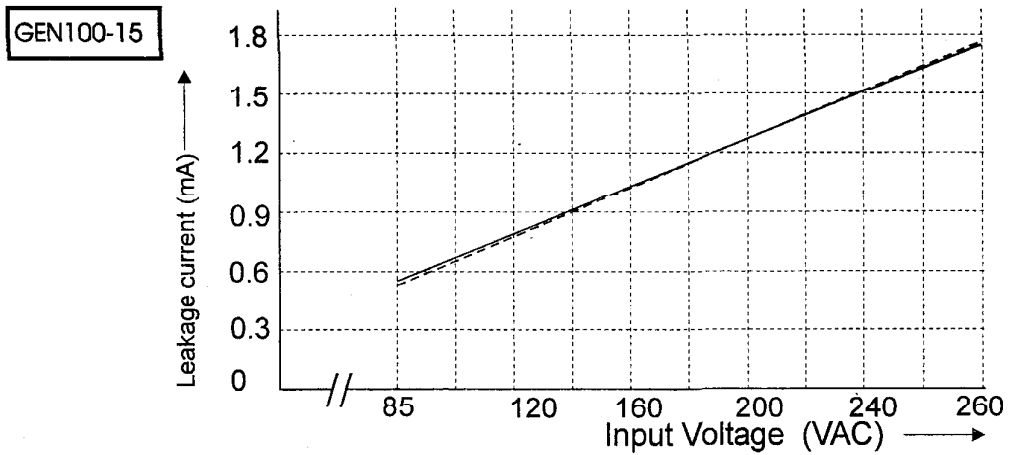
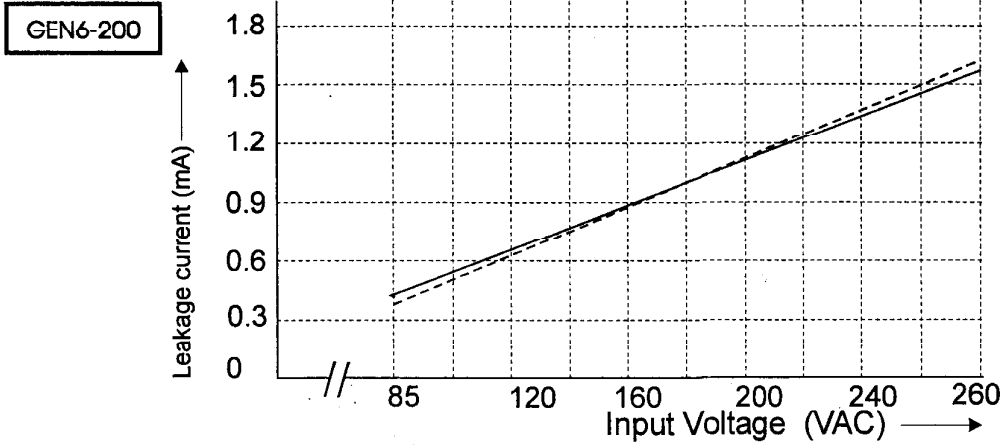

Leakage current characteristics

GEN1500

Conditions: Vout:100%
 Iout: 100% ———
 0% - - - -
 Ta:25°C

NEUTRAL-GND.

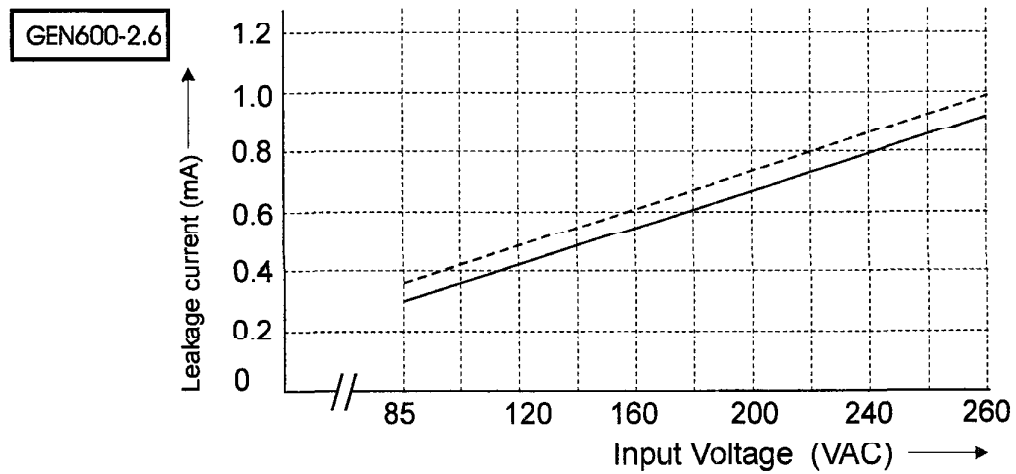
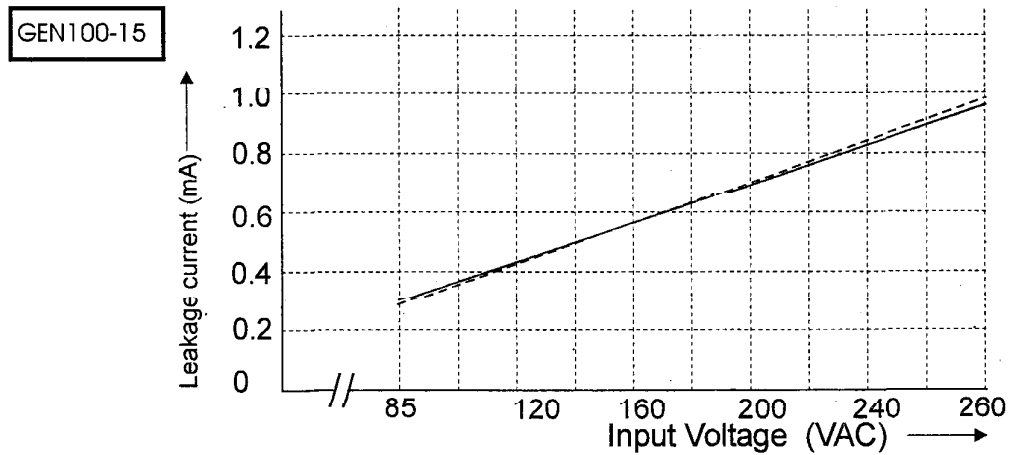
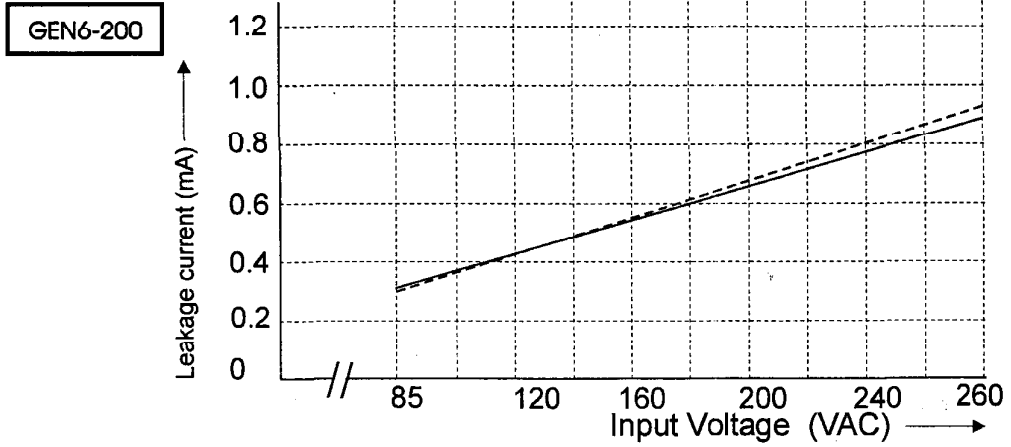

2-14. Output Ripple & Noise waveform
Constant Voltage Mode

GEN1500

Normal Mode

Conditions: V_{in} : 85-265VAC
 V_{out} : 100%
 I_{out} : 100 %
 T_a : 25°C

GEN6-200

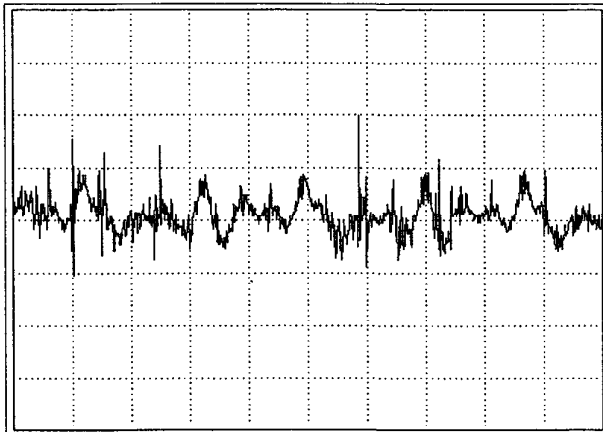

← V_{out}

10mV/DIV 2 μ s/DIV

GEN60-25

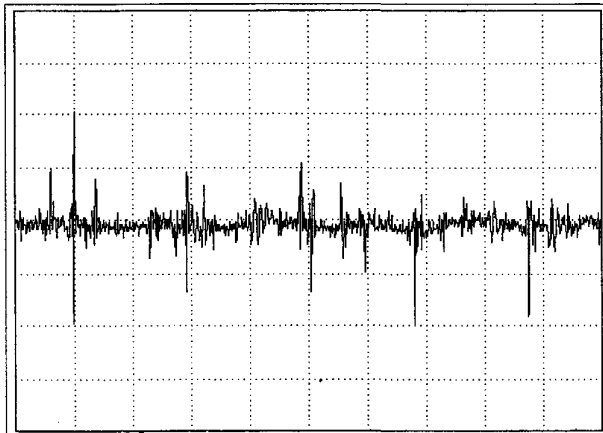

← V_{out}

10mV/DIV 2 μ s/DIV

Output Ripple & Noise waveform
Constant Voltage Mode

GEN1500

Normal Mode

Conditions: V_{in} :85-265VAC
 V_{out} : 100%
 I_{out} :100 %
 T_a :25°C

GEN100-15

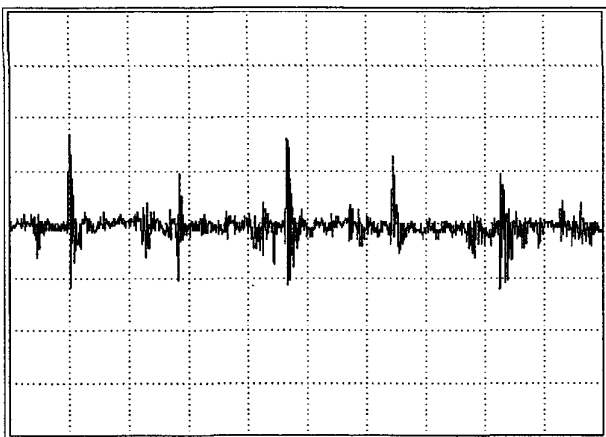

← V_{out}

10mV/DIV 2 μ s/DIV

GEN600-2.6

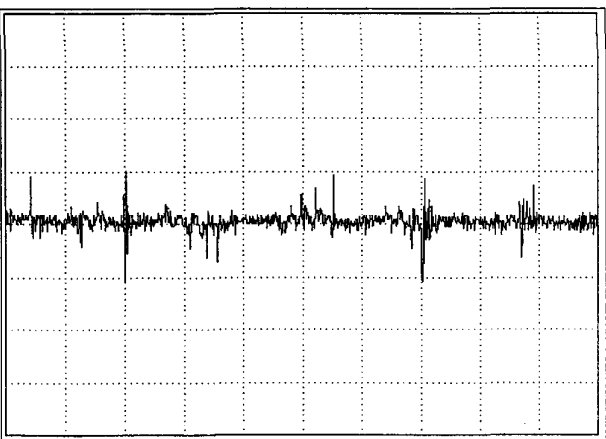

← V_{out}

50mV/DIV 2 μ s/DIV

Output Ripple & Noise waveform
Constant Voltage Mode

GEN1500

Normal & Common Mode

Conditions: V_{in} :85-265VAC
 V_{out} : 100%
 I_{out} : 100 %
 T_a :25°C

GEN6-200

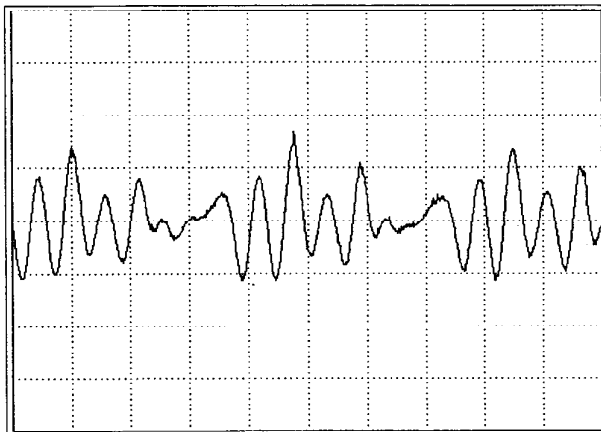

20mV/DIV 2µs/DIV

GEN60-25

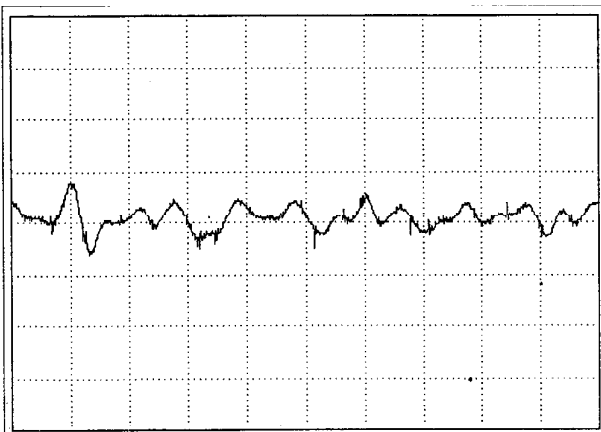

50mV/DIV 2µs/DIV

Output Ripple & Noise waveform
Constant Voltage Mode

GEN1500

Normal & Common Mode

Conditions: V_{in} :85-265VAC
 V_{out} : 100%
 I_{out} :100 %
 T_a :25°C

GEN100-15

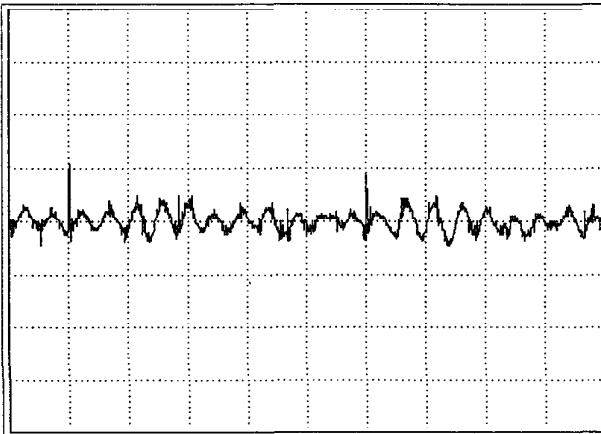

← Vout

10mV/DIV 2μs/DIV

GEN600-2.6

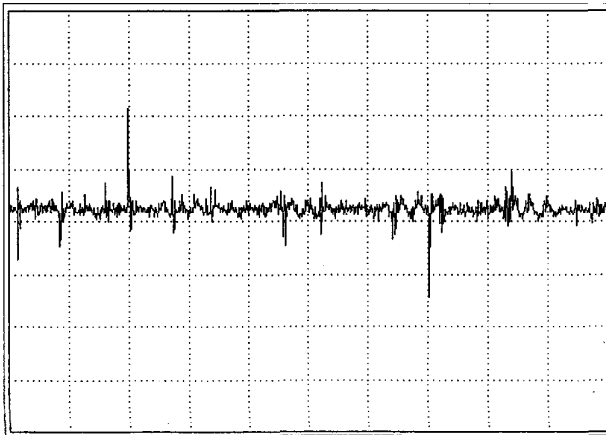

← Vout

20mV/DIV 2μs/DIV