

GSP 10kW

EVALUATION

DATA

DWG: IA813-53-01		
APPD	CHK	DWG
Yaniv 18/11/18	Yaniv 18/11/18	MICHAEL G. 19. 11. 2018

TDK-LAMBDA

INDEX**PAGE****1. EVALUATION METHOD****1.1 Circuit used for determination**

(1) Steady state data	T-1
(2) Over voltage protection (OVP) characteristics	T-1
(3) Output rise/fall characteristics	T-1
(4) Dynamic line response characteristic	T-2
(5) Dynamic load response characteristics	T-2
(6) Inrush current characteristics	T-3
(7) Leakage current characteristics	T-3
(8) Output ripple & noise waveform 10V to 300V models	T-3
(9) Output ripple & noise waveform for models higher than 300V	T-4

1.2 List of equipment used

T-5

2. CHARACTERISTICS**2.1 Steady state data**

(1) Regulation - Line & Load, Temperature drift	T-6~13
(2) Output voltage and ripple voltage VS input voltage	T-14~17
(3) Efficiency and Input current VS Output current	T-18~21

2.2 Warm up voltage drift & temperature stability

T-22~23

2.3 Over voltage protection (OVP) characteristic

T-24~25

2.4 ON/OFF Output rise characteristics

T-26~33

2.5 ON/OFF Output fall characteristics

T-34~41

2.6 Hold up time characteristic

T-42~45

2.7 Dynamic line response

T-46~55

2.8 Dynamic load response

T-56~61

2.9 Response to brown-out characteristic

T-62~73

2.10 Inrush current waveform

T-74~75

2.11 Input current waveform

T-76~78

2.12 Leakage current characteristic

T-79

2.13 Output ripple & noise waveform

T-80~81

TERMINOLOGY USED**Definition**

V_{in}	Input voltage
V_{out}	Output voltage
I_{in}	Input current
I_{out}	Output current
T_a	Ambient temperature
C.V	Constant voltage mode
C.C	Constant current mode

1. EVALUATION METHOD

1.1 Circuit used for determination

(1) Steady state data

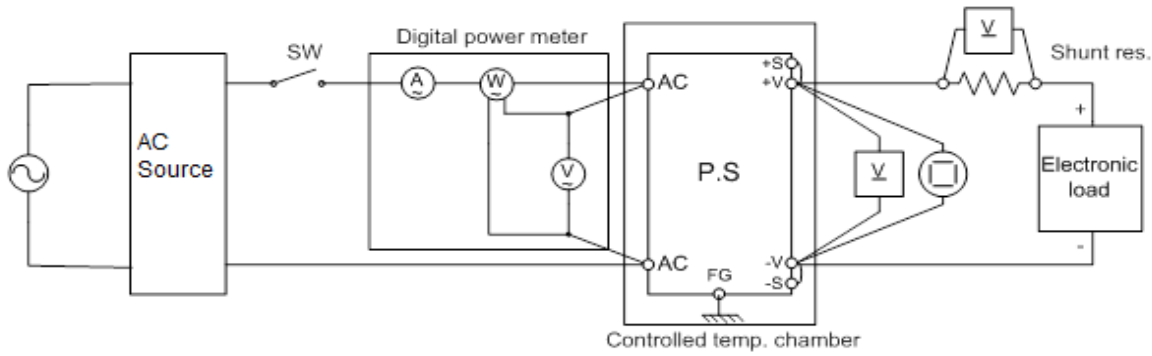

(2) Over voltage protection (OVP) characteristics

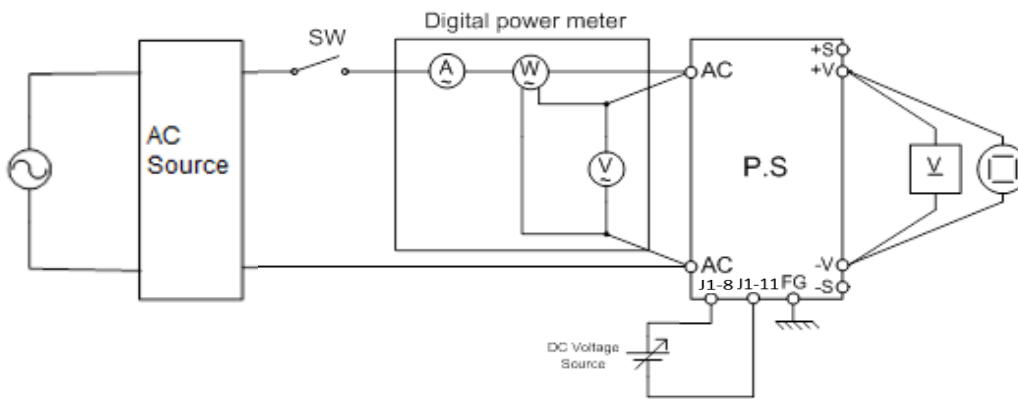

(3) Output rise/fall characteristics

Constant Voltage mode

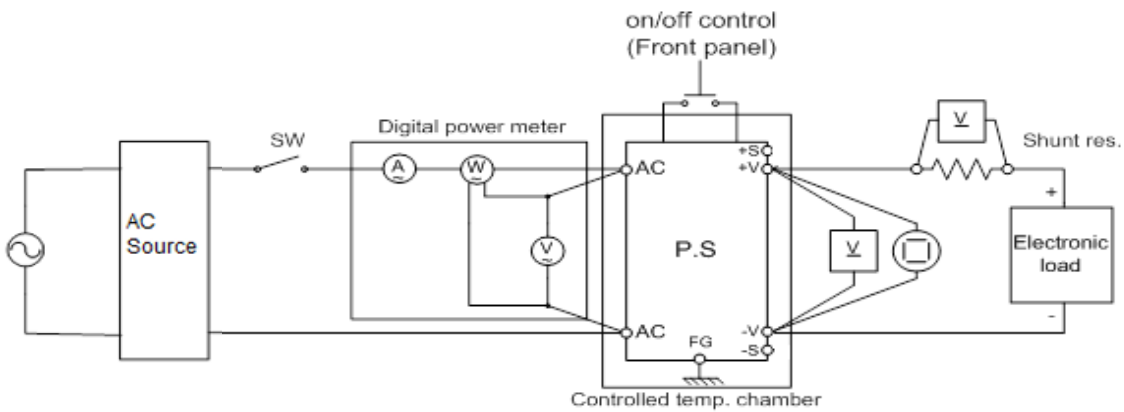

Constant Current mode

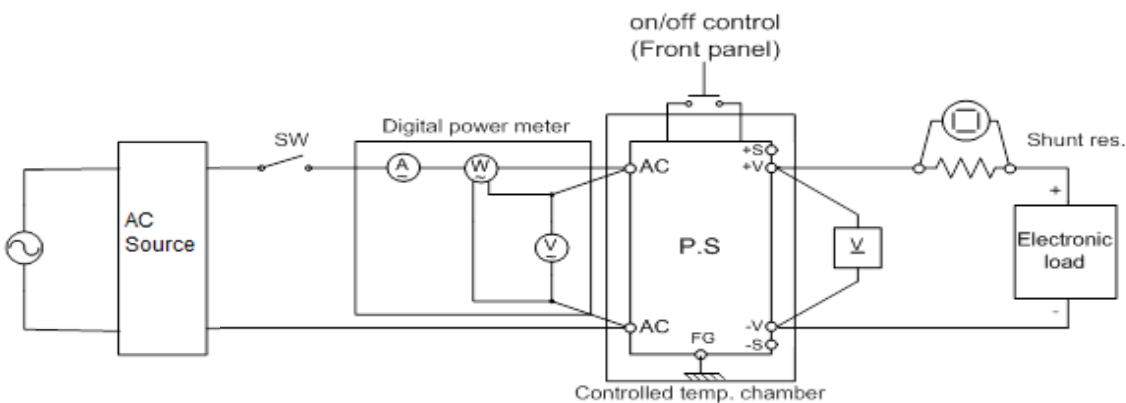

(4) Dynamic line response characteristics

Constant Voltage mode

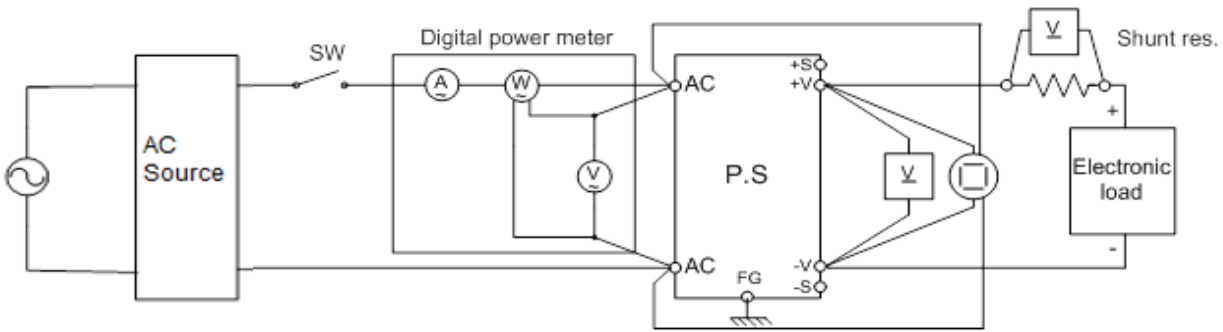

Constant Current mode

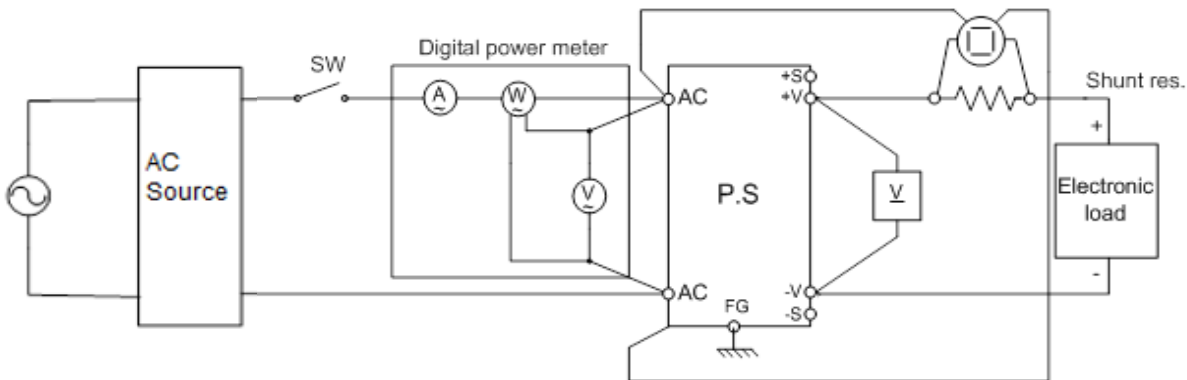

(5) Dynamic load response characteristics

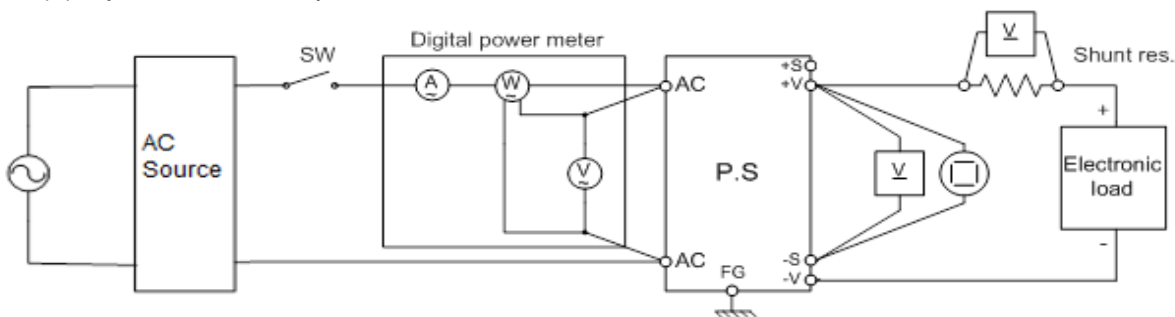

Output current waveform

lout 0% <---> 100%

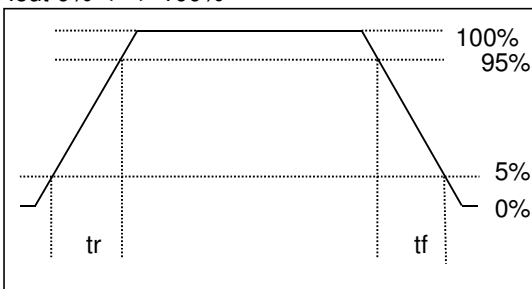

Output current waveform

lout 50% <---> 100%

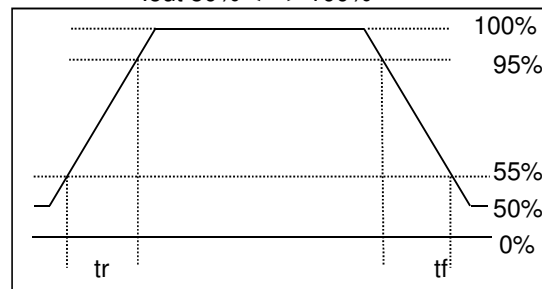

Constant Voltage mode

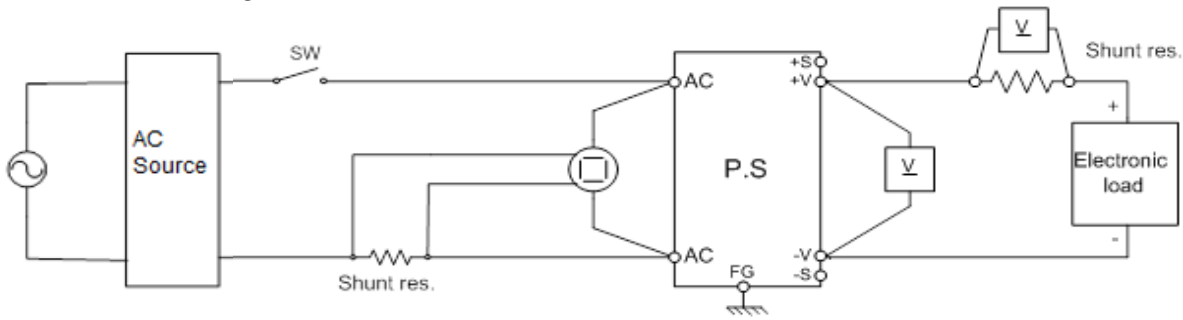

(7) Leakage current characteristics

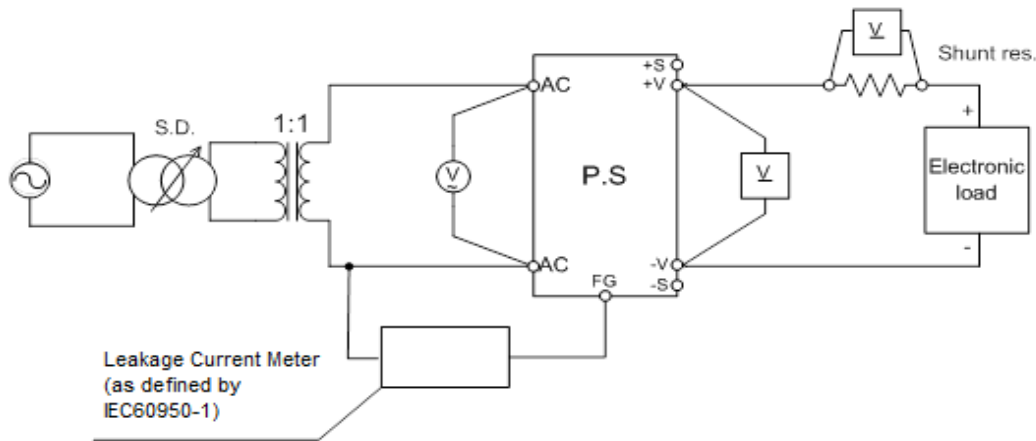

(8) Output ripple & noise waveform (10V to 300V models)

(a) Normal mode (JEITA Standard RC-9131A)

Oscilloscope
Noise: 20MHz
Ripple: 1MHz

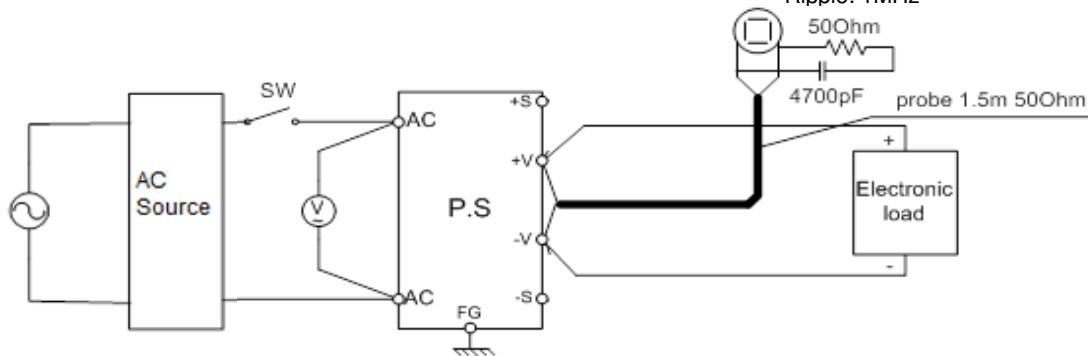

(b) Normal + Common mode

Oscilloscope
Noise: 20MHz
Ripple: 1MHz

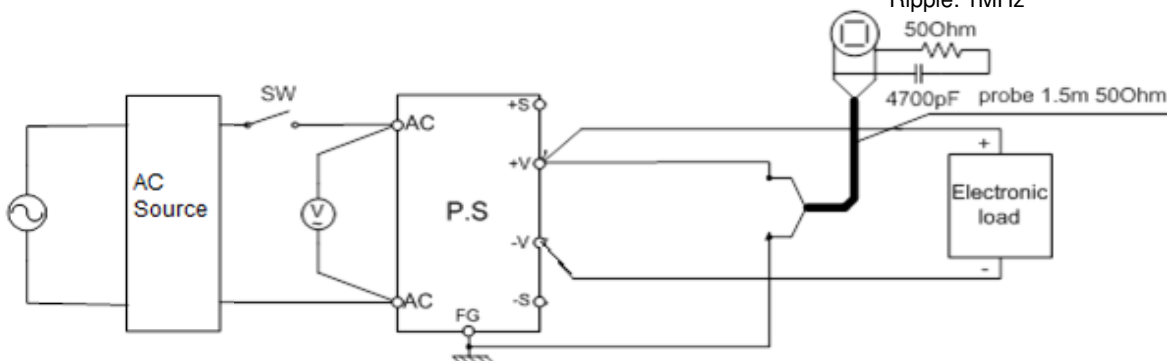

(9) Output ripple & noise waveform (400V to 600V models)

(a) Normal mode

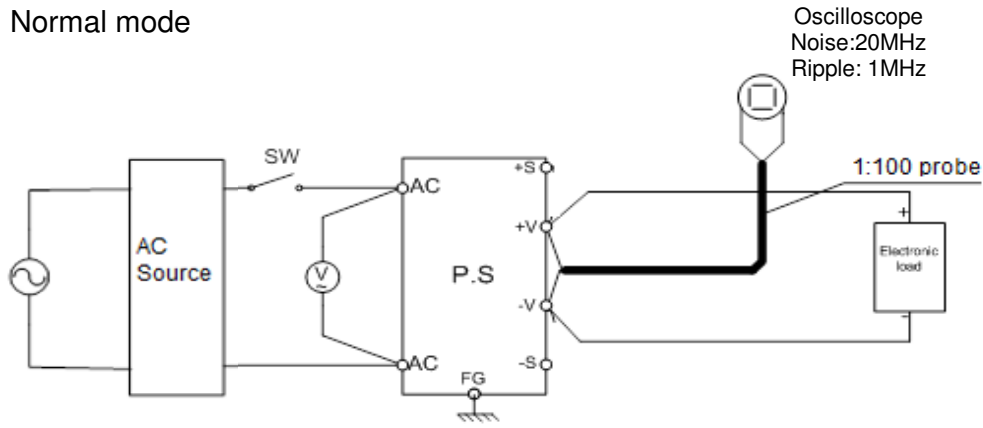

(b) Normal + Common mode

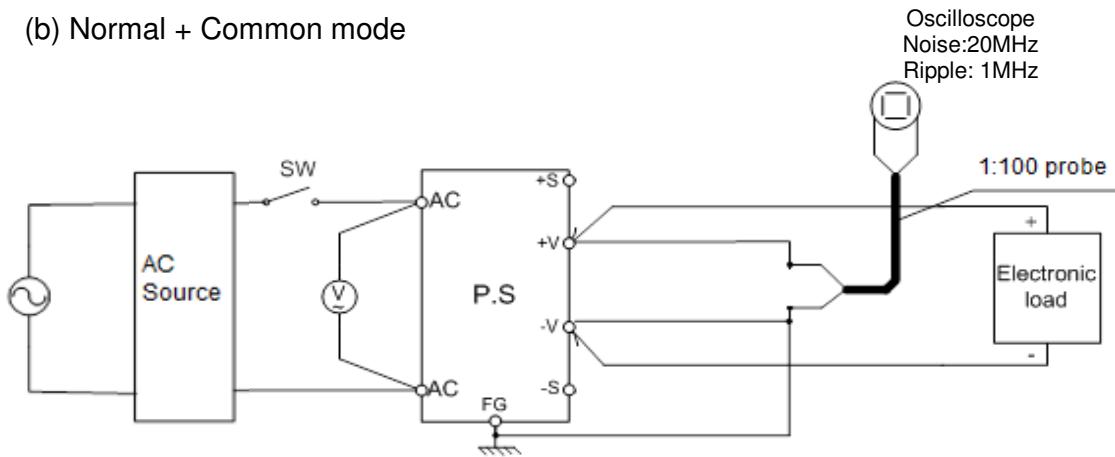

1.2 List of equipment used

	EQUIPMENT USED	MANUFACTURER	MODEL No.
1	Storage oscilloscope	YOKOGAWA	DLM2034
2	Storage oscilloscope	YOKOGAWA	DL1740
3	Digital multimeter	AGILENT	34401A
4	Digital power meter	YOKOGAWA	WT230
5	Digital power meter	YOKOGAWA	WT330
6	Digital power meter	YOKOGAWA	WT333E
7	Digital power meter	CHROMA	66203
8	AC Source	CHROMA	61512
9	Variable Transformer	STAGO ENERGY	6020E-6Y
10	Electronic load	H&H	ZS6060
11	Electronic load	H&H	ZS7006
12	Electronic load	H&H	ZS7060
13	Electronic load	H&H	ZS8006
14	Electronic load	CHROMA	63203
15	Electronic load	CHROMA	63204
16	Electronic load	CHROMA	63206A
17	Controlled temp. chamber	THERMOTRON	SM-16-3800
18	Controlled temp. chamber	THERMOTRON	SE-600-5-5
19	Controlled temp. chamber	THERMOTRON	SE-600-6-6
20	Leakage current tester	KIKUSUI	TOS3200
21	Current probe	YOKOGAWA	701931
22	Transducer	LEM	IT700-SB
23	Transducer	LEM	IT60-S
24	Current Measure	LEM	IN 2000-S

(1). Regulation - Line & Load, Temperature drift

GSP10-1000

Conditions: Ta = 25°C

1. Regulation - Line & Load, C.V mode 3Φ200

Io	Vin				Line Regulation	
	170VAC	200VAC	208VAC	265VAC		
0%	9.9994	9.9993	9.9993	9.9993	0.1	0.001%
25%	9.9994	9.9992	9.9992	9.9992	0.2	0.002%
50%	9.9992	9.9991	9.9991	9.9991	0.1	0.001%
75%	9.9990	9.9989	9.9989	9.9989	0.1	0.001%
100%	9.9989	9.9988	9.9988	9.9988	0.1	0.001%
Load	0.5	0.5	0.5	0.5	ΔV(mV)	
Regulation	0.005%	0.005%	0.005%	0.005%		

2. Regulation - Line & Load, C.V mode 3Φ400/3Φ480

Io	Vin						Line Regulation	
	342VAC	380VAC	400VAC	460VAC	480VAC	520VAC		
0%	10.0009	10.0009	10.0009	10.0009	10.0009	10.0008	0.03	0.000%
25%	10.0008	10.0007	10.0007	10.0007	10.0007	10.0007	0.1	0.001%
50%	10.0007	10.0006	10.0006	10.0006	10.0006	10.0006	0.1	0.001%
75%	10.0006	10.0004	10.0004	10.0004	10.0004	10.0004	0.2	0.002%
100%	10.0004	10.0002	10.0002	10.0002	10.0002	10.0002	0.2	0.002%
Load	0.5	0.7	0.7	0.7	0.7	0.6	ΔV(mV)	
Regulation	0.005%	0.007%	0.007%	0.007%	0.007%	0.006%		

3. Temperature drift, C.V mode

Conditions: Vin:200V 3Φ
Iout:100%

Ta	0°C	25°C	50°C	Temp. Coefficient (0°C~50°C)		
Vout	9.9941	9.9937	9.9928	1.3	mV	3 ppm/°C

(1). Regulation - Line & Load

GSP60-170

Conditions: Ta = 25°C

1. Regulation - Line & Load, C.V mode 3Φ400/3Φ480

Io	Vin					Line Regulation	
	342VAC	380VAC	400VAC	430VAC	460VAC		
0%	60.0088	60.0087	60.0088	60.0088	60.0086	0.2	0.000%
25%	60.0082	60.0081	60.0081	60.0081	60.0081	0.1	0.000%
50%	60.0076	60.0077	60.0077	60.0078	60.0078	0.2	0.000%
75%	60.0076	60.0075	60.0075	60.0075	60.0075	0.1	0.000%
100%	60.0071	60.0073	60.0074	60.0074	60.0074	0.3	0.000%
Load	1.7	1.4	1.4	1.4	1.2	$\Delta V(mV)$	
Regulation	0.003%	0.002%	0.002%	0.002%	0.002%		

(1). Regulation - Line & Load

GSP150-68

Conditions: Ta = 25°C

1. Regulation - Line & Load, C.V mode 3Φ200

Io	Vin				Line Regulation	
	170VAC	200VAC	208VAC	265VAC		
0%	149.9994	149.9996	149.9996	149.9996	0.2	0.000%
25%	149.9973	149.9973	149.9970	149.9974	0.5	0.000%
50%	149.9955	149.9955	149.9955	149.9956	0.1	0.000%
75%	149.9939	149.9939	149.9938	149.9937	0.2	0.000%
100%	149.9915	149.9917	149.9921	149.9919	0.6	0.000%
Load	7.9	7.8	7.5	7.7	$\Delta V(mV)$	
Regulation	0.005%	0.005%	0.005%	0.005%		

(1). Regulation - Line & Load, Temperature drift

GSP600-17

Conditions: Ta = 25°C

1. Regulation - Line & Load, C.V mode 3Φ200

Io	Vin				Line Regulation	
	170VAC	200VAC	208VAC	265VAC		
0%	600.0890	600.0900	600.0910	600.0920	3.0	0.000%
25%	600.0880	600.0880	600.0890	600.0900	2.0	0.000%
50%	600.0850	600.0850	600.0860	600.0840	2.0	0.000%
75%	600.0800	600.0800	600.0810	600.0820	2.0	0.000%
100%	600.0760	600.0770	600.0760	600.0780	2.0	0.000%
Load	13.0	13.0	15.0	14.0	ΔV(mV)	
Regulation	0.002%	0.002%	0.002%	0.002%		

2. Regulation - Line & Load, C.V mode 3Φ400/3Φ480

Io	Vin						Line Regulation	
	342VAC	380VAC	400VAC	460VAC	480VAC	520VAC		
0%	600.0170	600.0190	600.0200	600.0210	600.0200	600.0220	5.0	0.001%
25%	600.0140	600.0150	600.0150	600.0150	600.0160	600.0160	2.0	0.000%
50%	600.0130	600.0140	600.0140	600.0140	600.0140	600.0140	1.0	0.000%
75%	600.0080	600.0080	600.0080	600.0090	600.0090	600.0090	1.0	0.000%
100%	600.0030	600.0040	600.0040	600.0030	600.0030	600.0040	1.0	0.000%
Load	14.0	15.0	16.0	18.0	17.0	18.0	ΔV(mV)	
Regulation	0.002%	0.002%	0.003%	0.003%	0.003%	0.003%		

3. Temperature drift, C.V mode

Conditions: Vin:480V 3Φ
Iout:100%

Ta	0°C	25°C	50°C	Temp. Coefficient (0°C~50°C)		
Vout	599.9880	600.0288	600.2248	236.79	mV	8 ppm/°C

(1). Regulation - Line & Load, Temperature drift

GSP10-1000

Conditions: Ta = 25°C

1. Regulation - Line & Load, C.C mode 3Φ200 (*)

Vo	Vin				Line Regulation	
	170VAC	200VAC	208VAC	265VAC		
0%	999.280	999.300	999.300	999.320	40.0	0.004%
25%	999.220	999.240	999.240	999.240	20.0	0.002%
50%	999.220	999.240	999.240	999.240	20.0	0.002%
75%	999.260	999.260	999.260	999.240	20.0	0.002%
100%	999.280	999.280	999.280	999.270	10.0	0.001%
Load Regulation	60.0	60.0	60.0	80.0	ΔI(mA)	
	0.006%	0.006%	0.006%	0.008%		

2. Regulation - Line & Load, C.C mode 3Φ400/3Φ480 (*)

Io	Vin						Line Regulation	
	342VAC	380VAC	400VAC	460VAC	480VAC	520VAC		
0%	999.7020	999.7060	999.7100	999.7140	999.7140	999.7200	18.0	0.002%
25%	999.6600	999.6600	999.6600	999.6600	999.6560	999.6540	6.0	0.001%
50%	999.6460	999.6500	999.6400	999.6600	999.6600	999.6600	20.0	0.002%
75%	999.6600	999.6600	999.6600	999.6540	999.6600	999.6600	6.0	0.001%
100%	999.7000	999.6900	999.6860	999.6800	999.6800	999.6600	40.0	0.004%
Load Regulation	56.0	56.0	70.0	60.0	58.0	66.0	ΔI(mA)	
	0.006%	0.006%	0.007%	0.006%	0.006%	0.007%		

3. Temperature drift, C.C mode

Conditions:

Vin:200V 3Φ
Iout:100%

Ta	0°C	25°C	50°C	Temp. Coefficient (0°C~50°C)	
Iout	999.41	999.07	998.87	536 mA	11 ppm/°C

Notes:

(*) Not including load regulation thermal drift effect.

(1). Regulation - Line & Load

GSP60-170

Conditions: Ta = 25°C

1. Regulation - Line & Load, C.C mode 3Φ400/3Φ480 (*)

Io	Vin					Line Regulation	
	342VAC	380VAC	400VAC	430VAC	460VAC		
0%	169.9574	169.9555	169.9543	169.9532	169.9528	4.6	0.003%
25%	169.9549	169.9537	169.9529	169.9527	169.9522	2.7	0.002%
50%	169.9508	169.9503	169.9497	169.9493	169.9491	1.7	0.001%
75%	169.9500	169.9499	169.9497	169.9497	169.9499	0.3	0.000%
100%	169.9454	169.9456	169.9455	169.9456	169.9455	0.2	0.000%
Load	12.0	9.9	8.8	7.6	7.3	ΔI(mA)	
Regulation	0.007%	0.006%	0.005%	0.004%	0.004%		

(1). Regulation - Line & Load

GSP150-68

Conditions: Ta = 25°C

1. Regulation - Line & Load, C.C mode 3Φ200 (*)

Vo	Vin				Line Regulation	
	170VAC	200VAC	208VAC	265VAC		
0%	67.9414	67.9415	67.9415	67.9414	0.1	0.000%
25%	67.9417	67.9417	67.9417	67.9419	0.2	0.000%
50%	67.9455	67.9455	67.9457	67.9456	0.2	0.000%
75%	67.9462	67.9462	67.9461	67.9463	0.2	0.000%
100%	67.9474	67.9473	67.9475	67.9475	0.2	0.000%
Load	6.0	5.8	6.1	6.1	ΔI(mA)	
Regulation	0.009%	0.009%	0.009%	0.009%		

(1). Regulation - Line & Load, Temperature drift

GSP600-17

Conditions: Ta = 25°C

1. Regulation - Line & Load, C.C mode 3Φ200 (*)

Vo	Vin				Line Regulation	
	170VAC	200VAC	208VAC	265VAC		
0%	16.9888	16.9889	16.9888	16.9888	0.1	0.001%
25%	16.9883	16.9882	16.9881	16.9880	0.2	0.001%
50%	16.9893	16.9889	16.9890	16.9889	0.4	0.002%
75%	16.9890	16.9889	16.9889	16.9888	0.2	0.001%
100%	16.9892	16.9892	16.9892	16.9884	0.8	0.005%
Load	1.0	1.0	1.0	0.8	ΔI(mA)	
Regulation	0.006%	0.006%	0.006%	0.005%		

2. Regulation - Line & Load, C.C mode 3Φ400/3Φ480 (*)

Io	Vin						Line Regulation	
	342VAC	380VAC	400VAC	460VAC	480VAC	520VAC		
0%	16.9965	16.9954	16.9954	16.9953	16.9952	16.9952	1.3	0.008%
25%	16.9958	16.9956	16.9956	16.9957	16.9957	16.9957	0.2	0.001%
50%	16.9956	16.9953	16.9952	16.9952	16.9951	16.9951	0.5	0.003%
75%	16.9952	16.9951	16.9951	16.9950	16.9949	16.9949	0.3	0.002%
100%	16.9939	16.9937	16.9937	16.9936	16.9936	16.9935	0.3	0.002%
Load	2.7	1.9	1.9	2.1	2.1	2.1	ΔI(mA)	
Regulation	0.016%	0.011%	0.011%	0.012%	0.012%	0.013%		

3. Temperature drift, C.C mode

Conditions: Vin:480V 3Φ
Iout:100%

Ta	0°C	25°C	50°C	Temp. Coefficient (0°C~50°C)	
Iout	16.9985	16.9943	16.9955	4.21 mA	5 ppm/°C

Notes:

(*) Not including load regulation thermal drift effect.

(2). Output voltage and ripple voltage vs. input voltage
C.V mode

Conditions: Iout:100%

Ta: 25°C

GSP10-1000 3Φ200

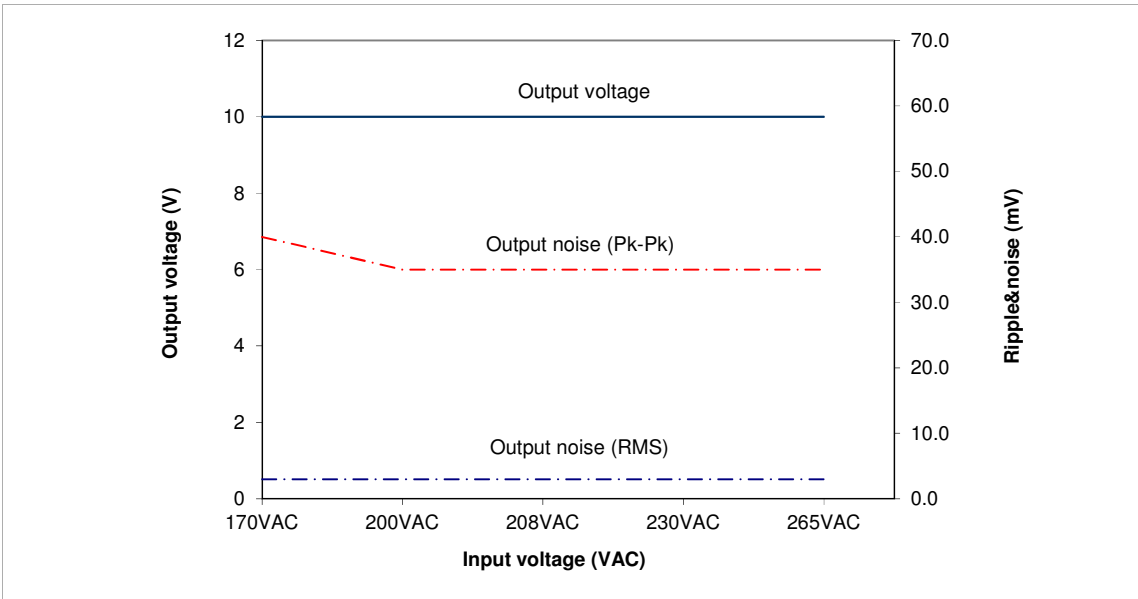

GSP10-1000 3Φ400/3Φ480

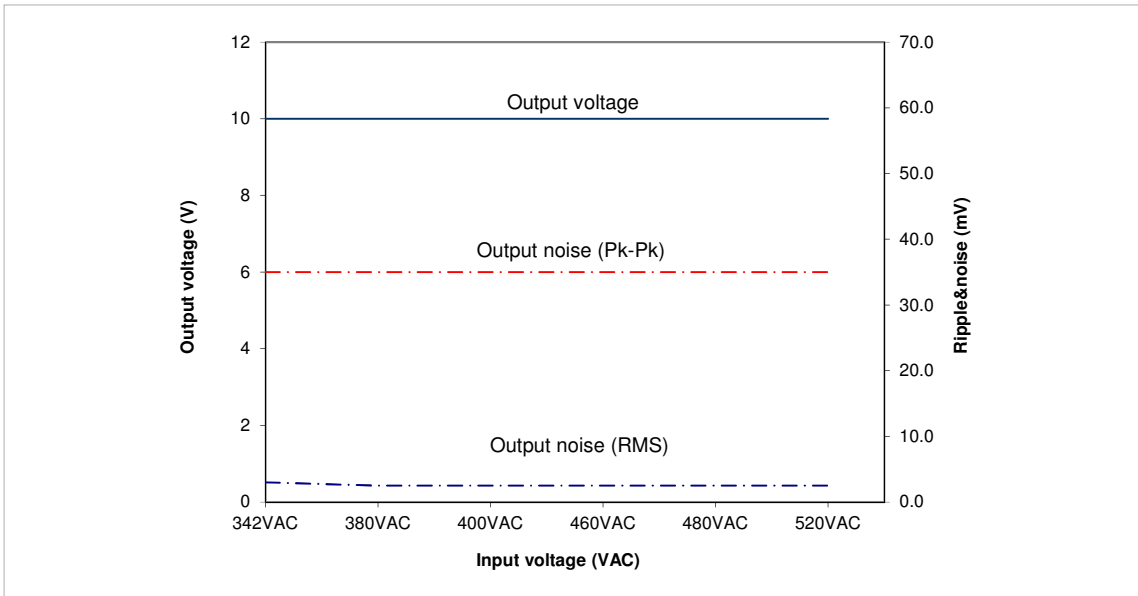

(2). Output voltage and ripple voltage vs. input voltage
C.V mode

Conditions: Iout:100%

Ta: 25°C

GSP60-170 3Φ400

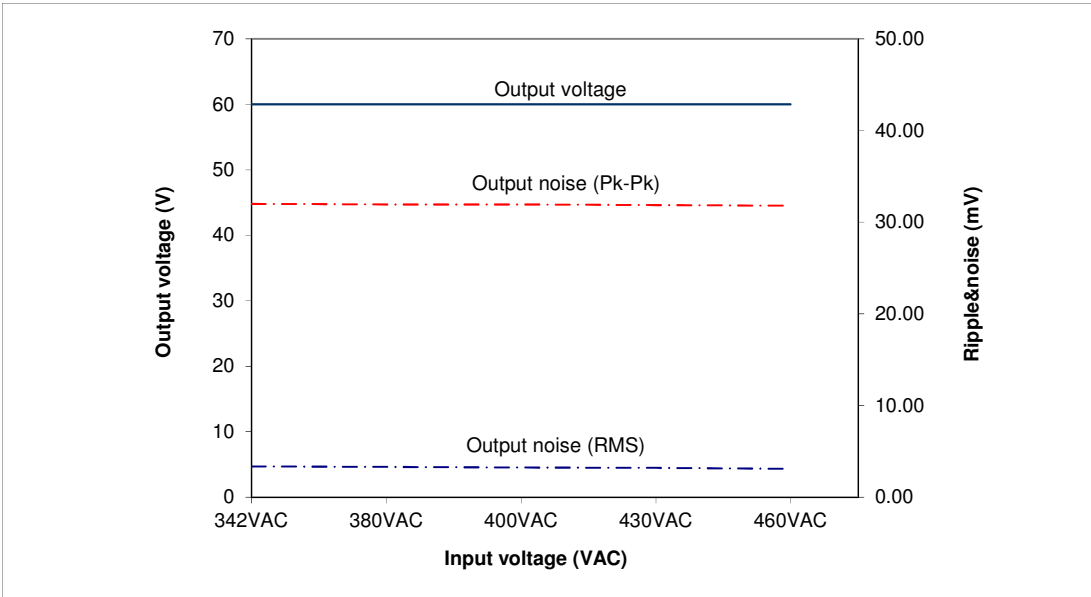

(2). Output voltage and ripple voltage vs. input voltage
C.V mode

Conditions: Iout:100%

Ta: 25°C

GSP150-68 3Φ200

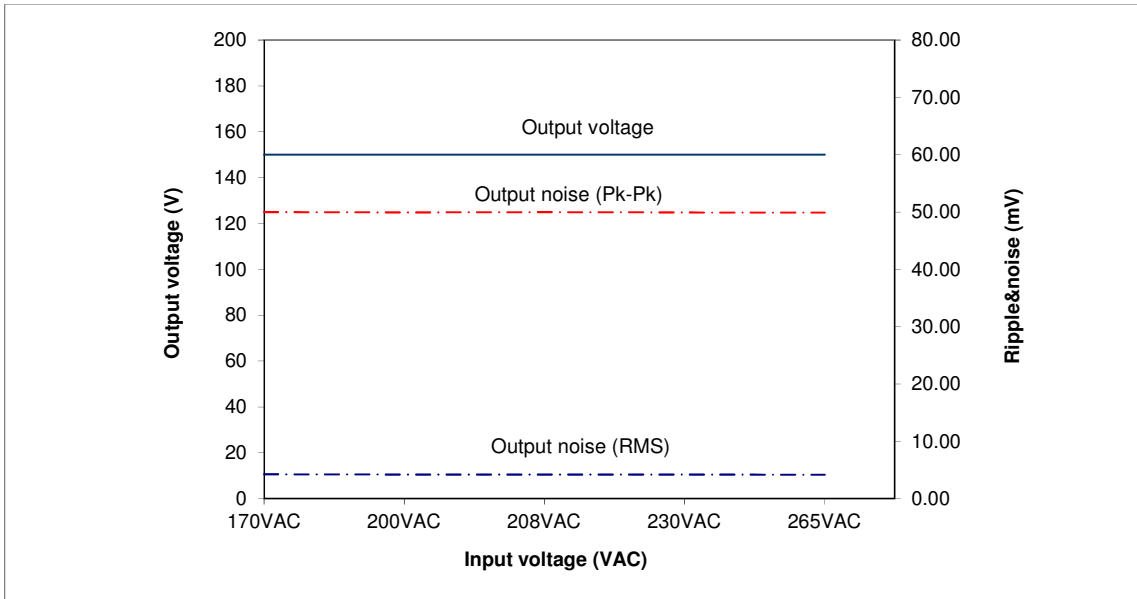

(2). Output voltage and ripple voltage vs. input voltage
C.V mode

Conditions: Iout:100%

Ta: 25°C

GSP600-17 3Φ200

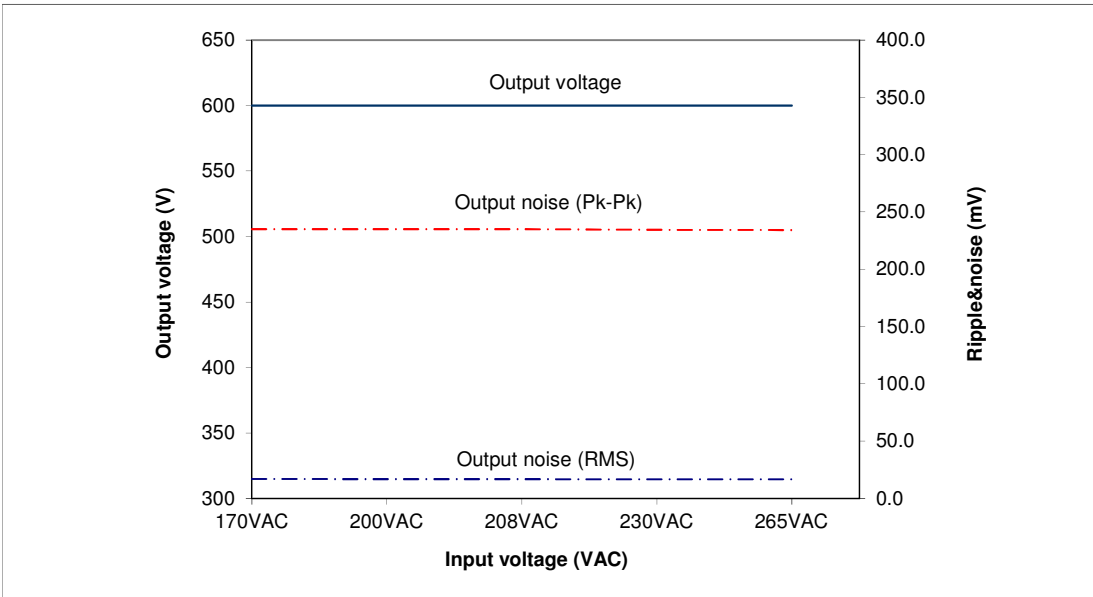

GSP600-17 3Φ400/3Φ480

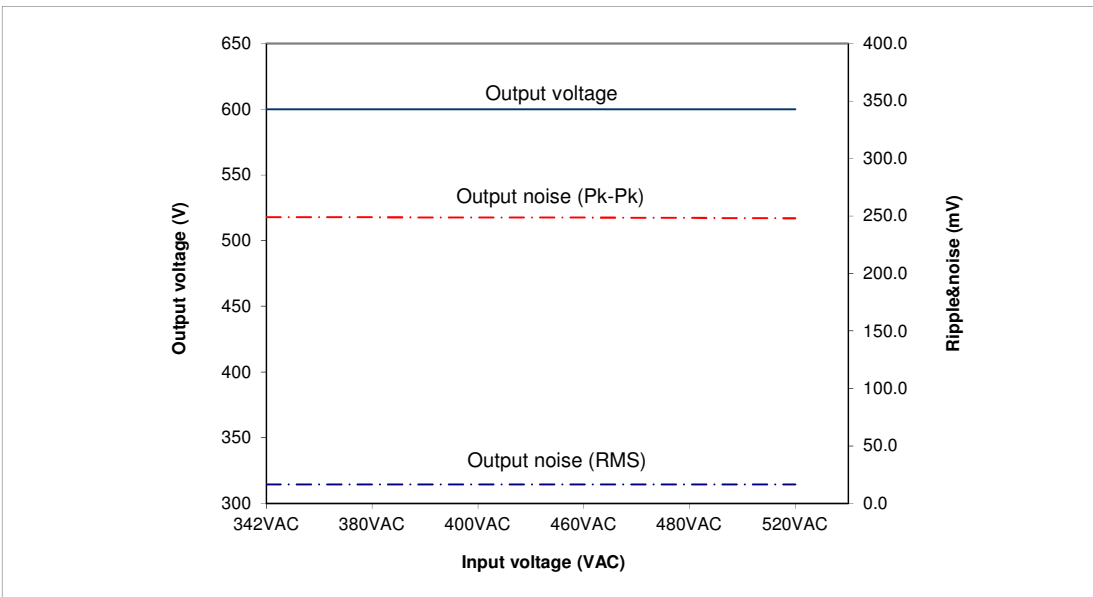

(3). Efficiency and Input current vs. Output current

GSP10-1000 3Φ200

Conditions:
 Vin: 170~265 VAC
 Vout: 100%
 Ta: 25°C

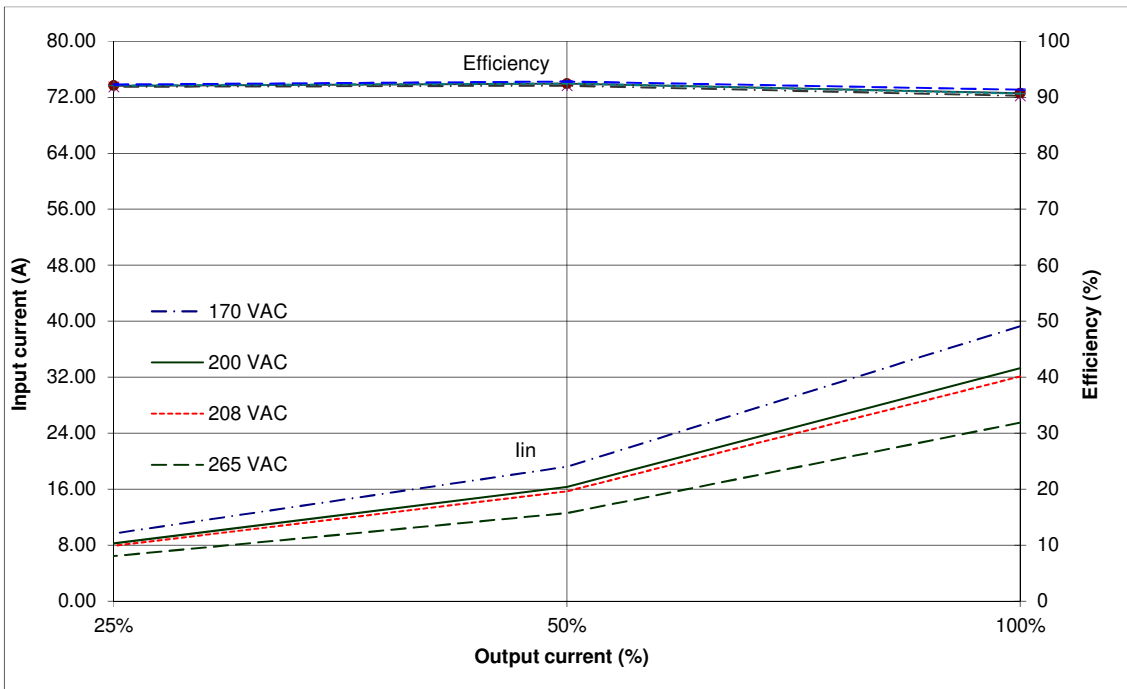

GSP10-1000 3Φ400/3Φ480

Conditions:
 Vin: 342~520 VAC
 Vout: 100%
 Ta: 25°C

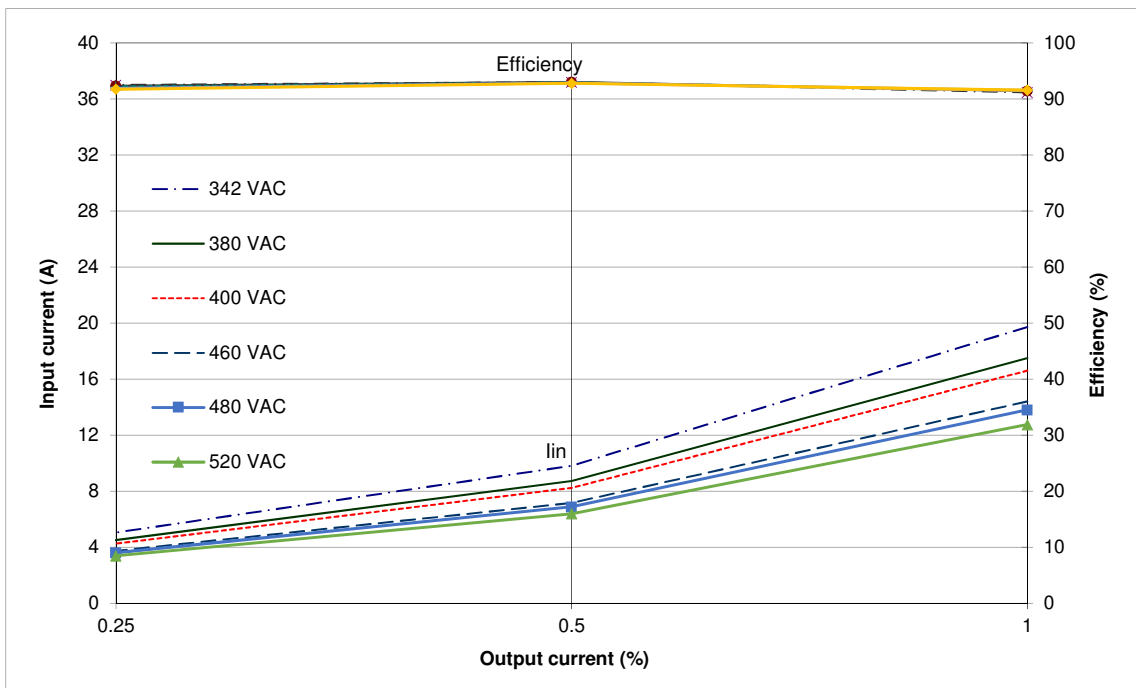

(3). Efficiency and Input current vs. Output current

GSP60-170 3Φ400/3Φ480

Conditions:
 Vin: 342~460 VAC
 Vout: 100%
 Ta: 25°C

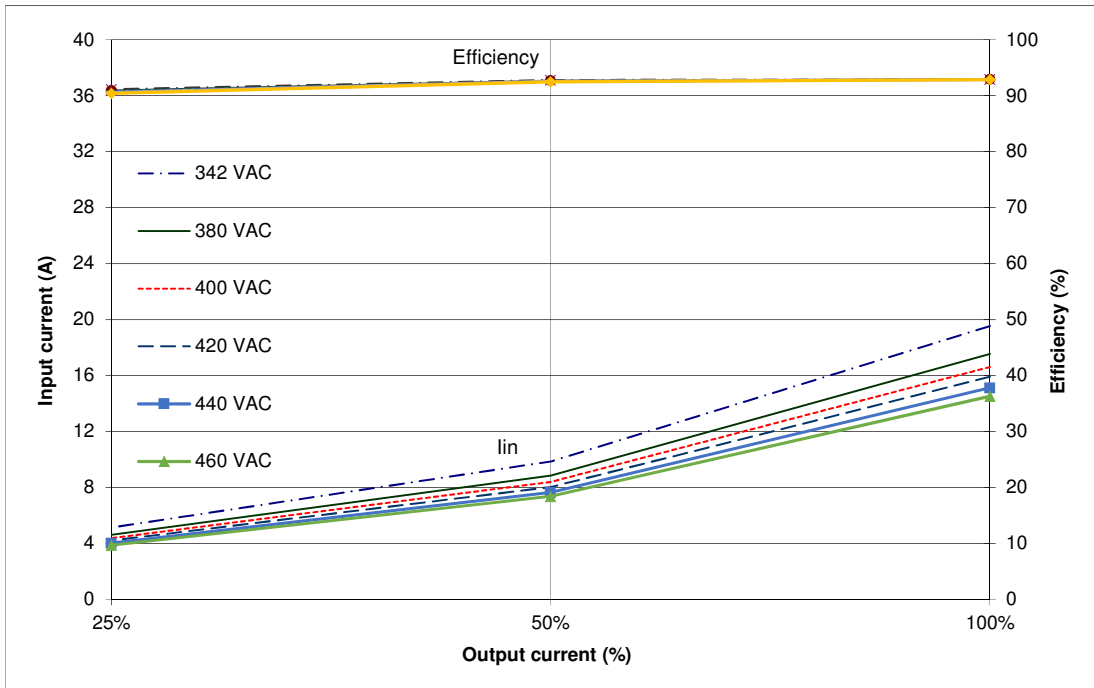

(3). Efficiency and Input current vs. Output current

GSP150-68 3Φ200

Conditions:
 Vin: 170~265 VAC
 Vout: 100%
 Ta: 25°C

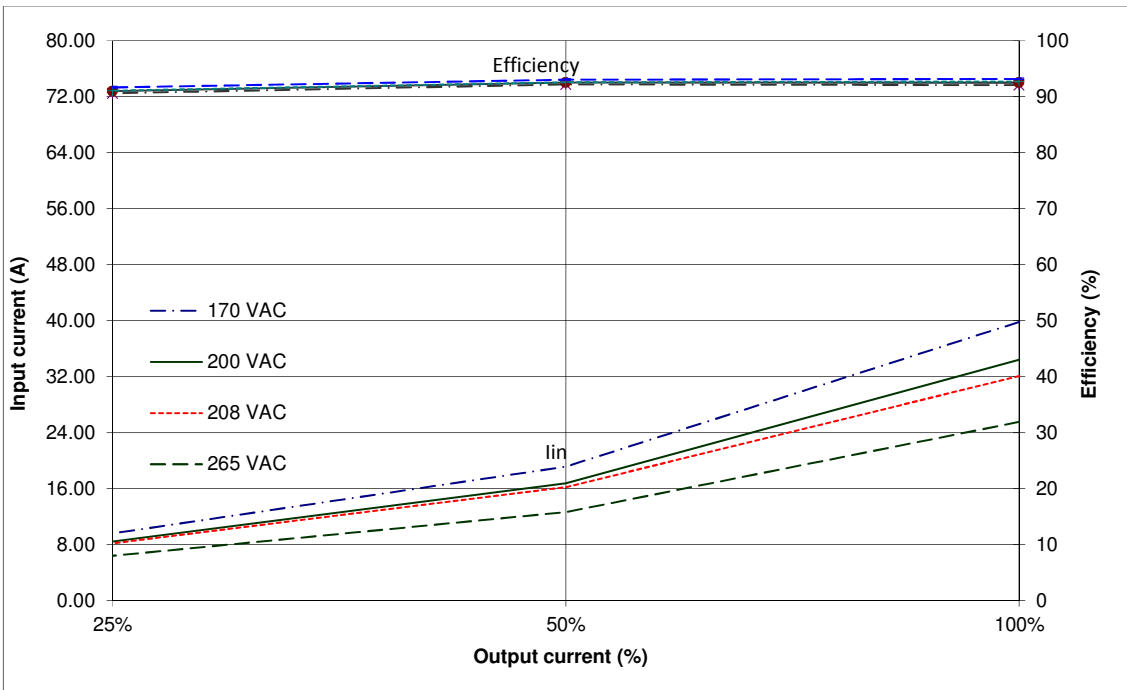

(3). Efficiency and Input current vs. Output current

GSP600-17 3Φ200

Conditions:
 Vin: 170~265 VAC
 Vout: 100%
 Ta: 25°C

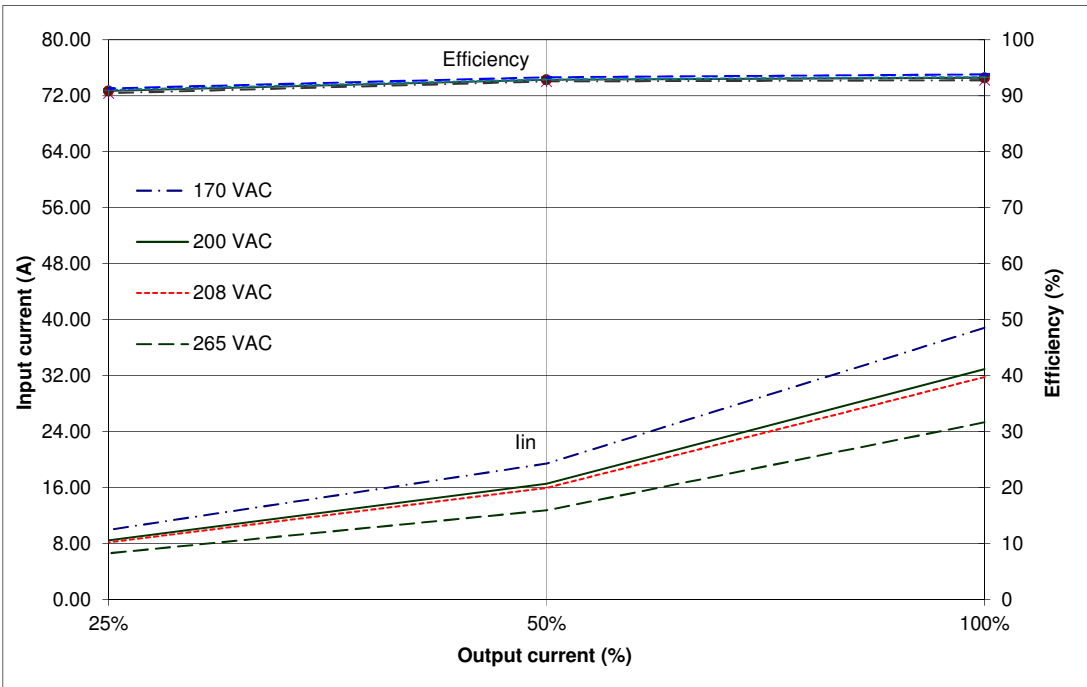

GSP600-17 3Φ400/3Φ480

Conditions:
 Vin: 342~520 VAC
 Vout: 100%
 Ta: 25°C

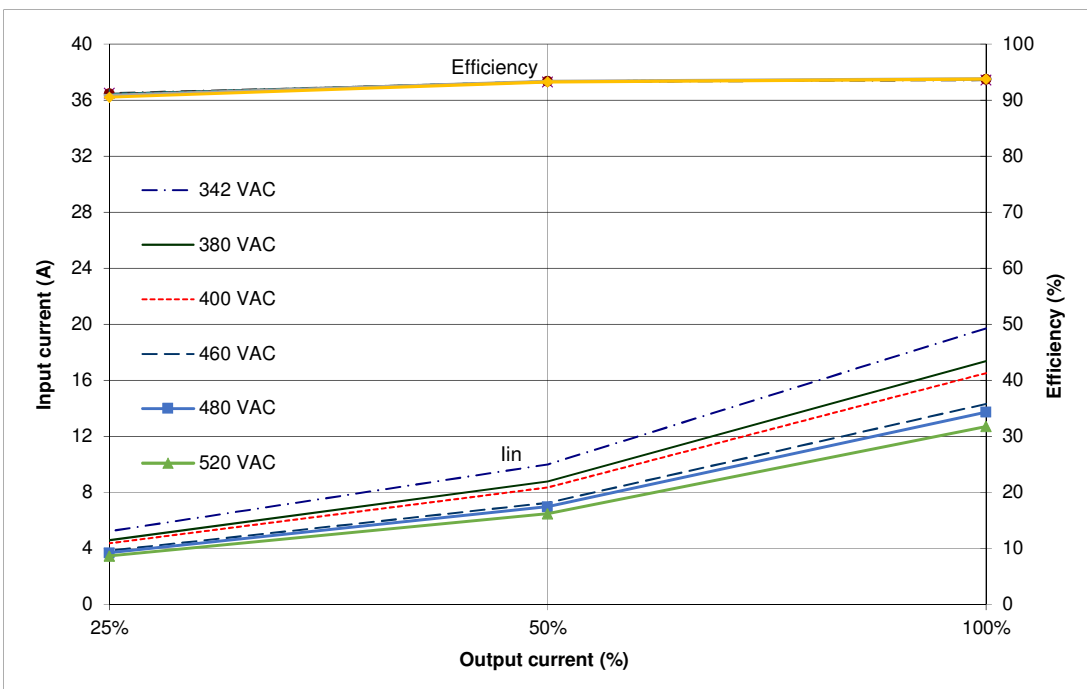

2.2 Warm up drift & stability

Conditions: Vout: 100%
Iout: 100%
Ta = 25°C

GSP10-1000 C.V mode

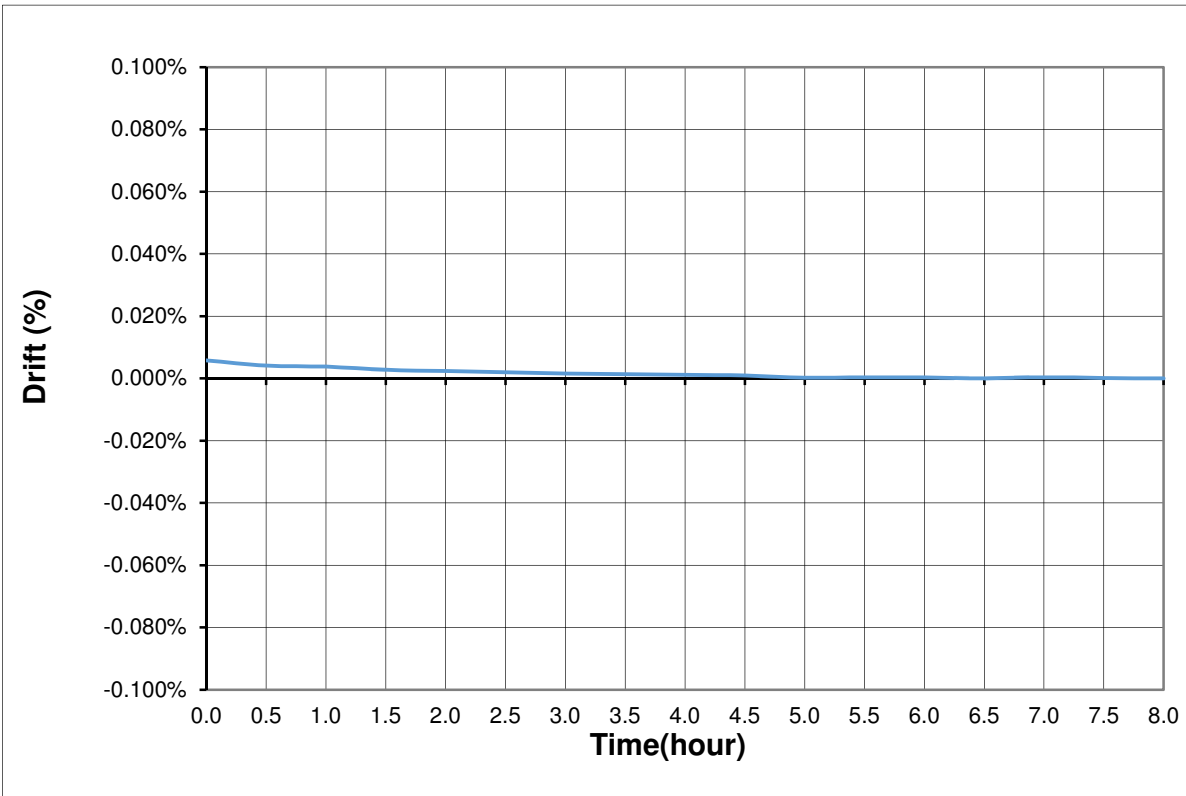

GSP10-1000 C.C mode

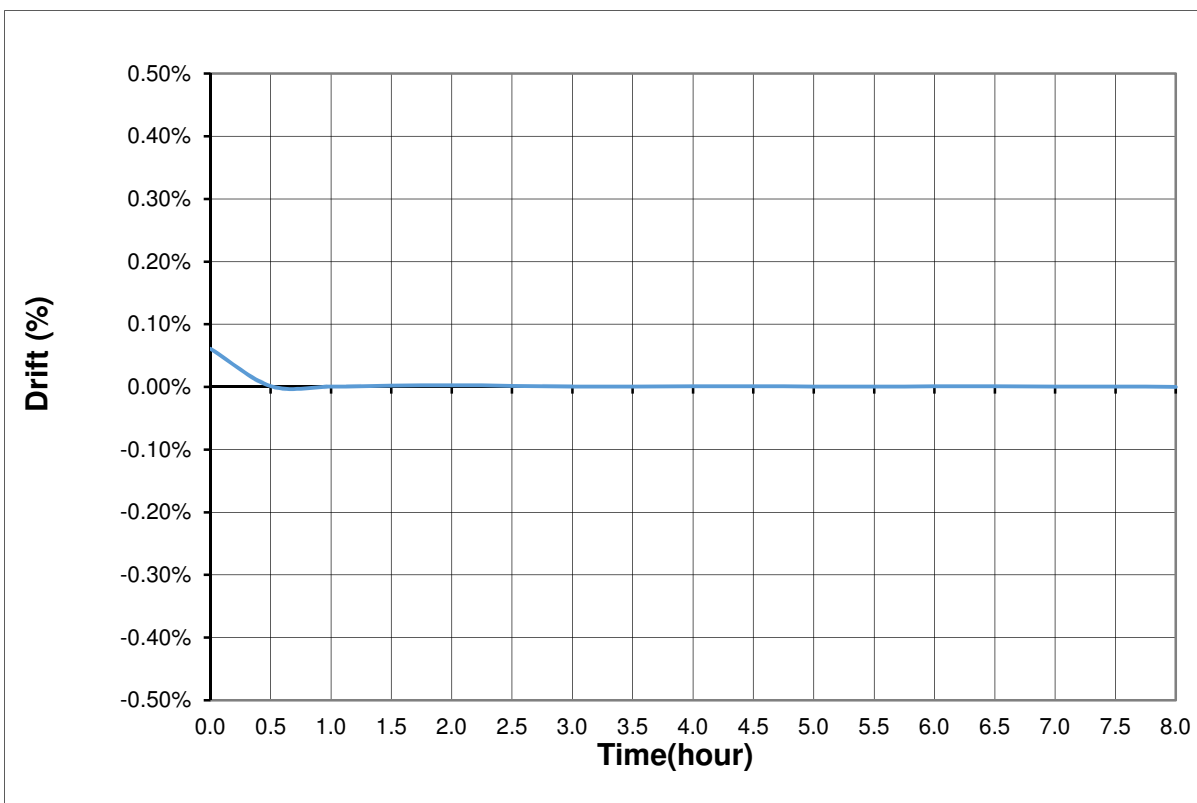

2.2 Warm up drift & stability

Conditions: Vout: 100%
Iout: 100%
Ta = 25°C

GSP600-17 C.V mode

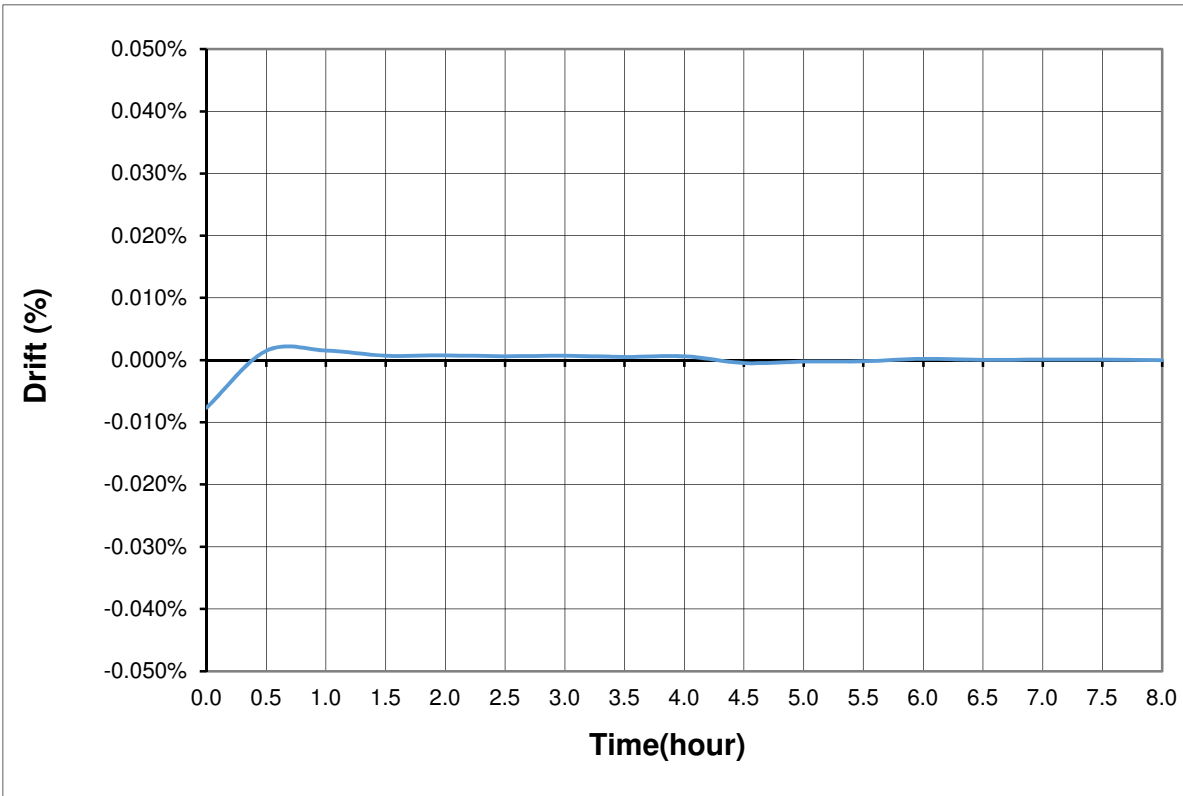

GSP600-17 C.C mode

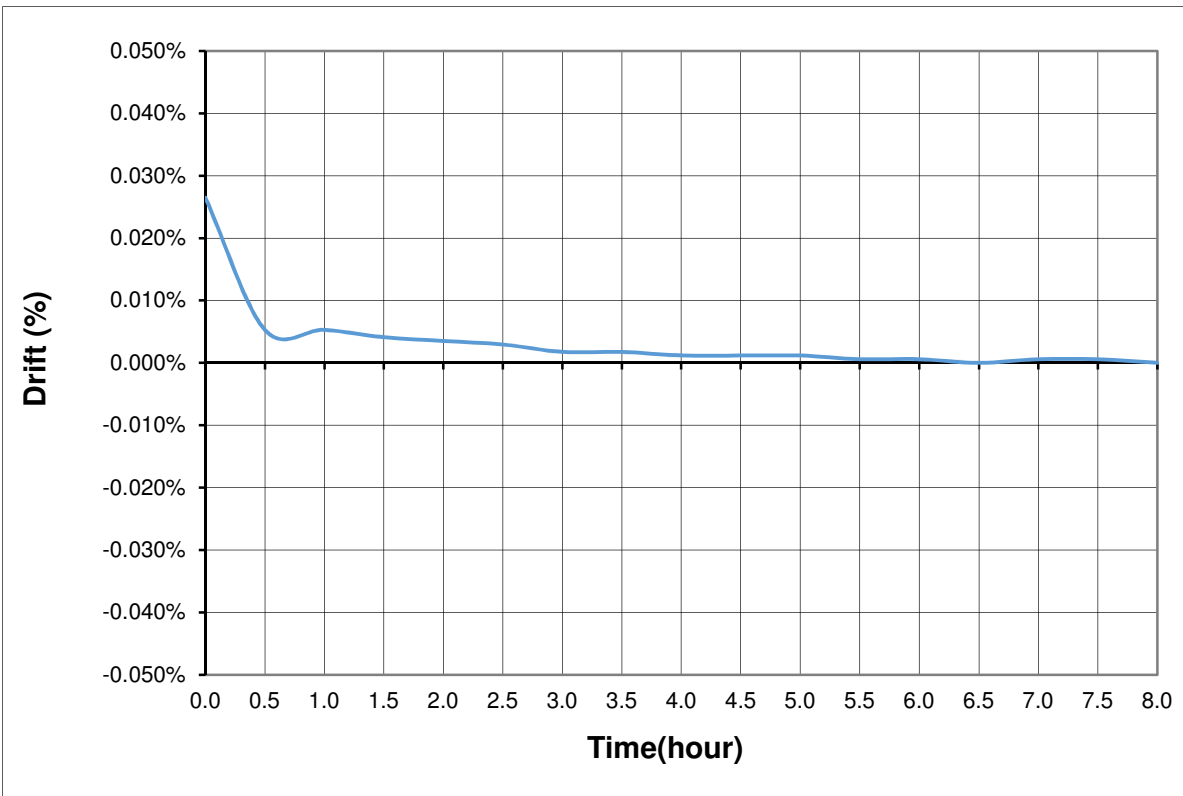

2.3 Over voltage protection (OVP) characteristic

Conditions: Vset: 100%
Iout: 0%
Ta = 25 °C

GSP10-1000

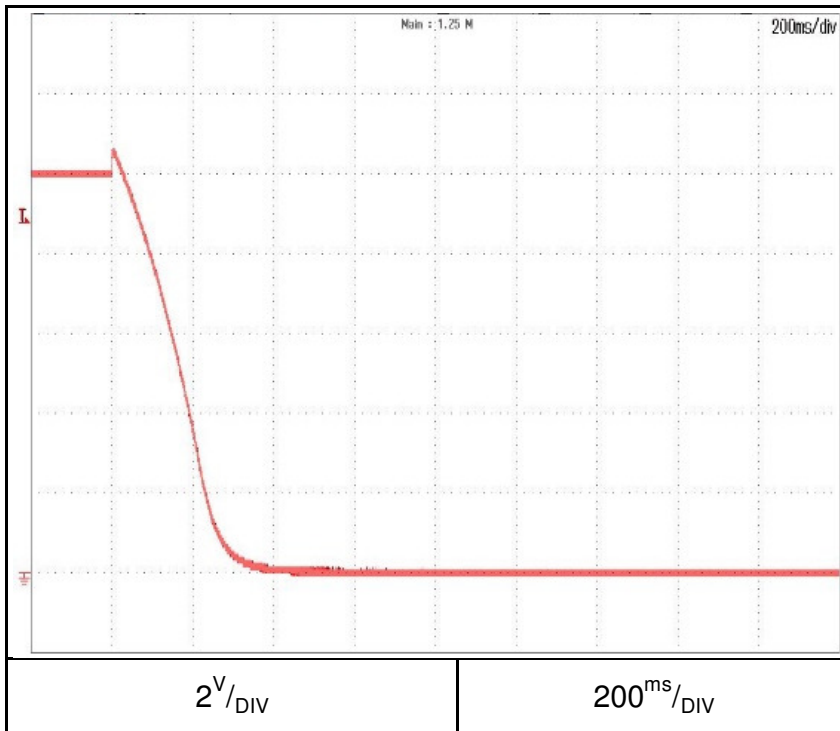

OVP setting:10.5V

GSP60-170

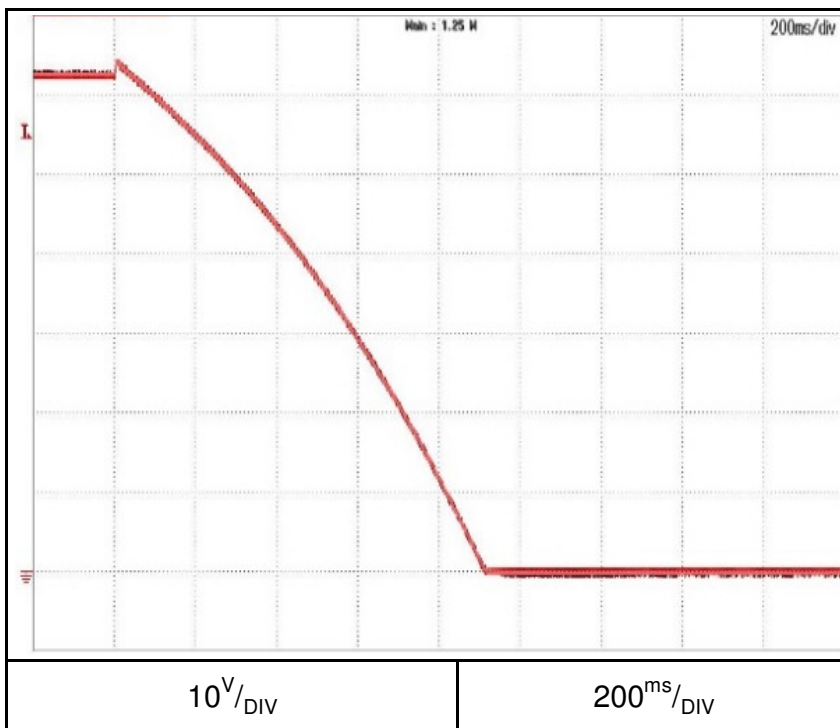

OVP setting:63V

2.3 Over voltage protection (OVP) characteristic

Conditions: Vset: 100%
Iout: 0%
Ta = 25 °C

GSP150-68

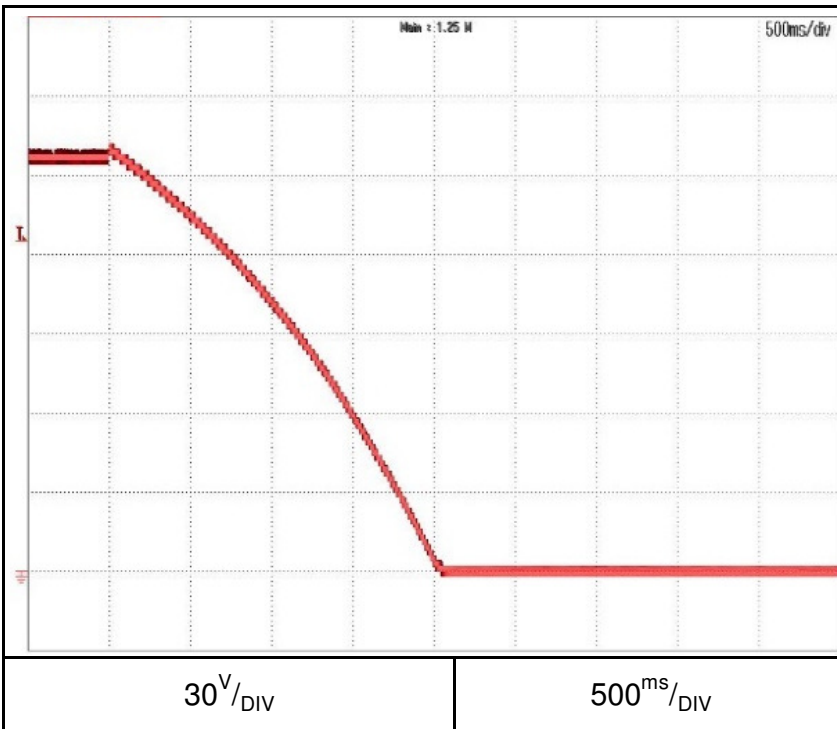

OVP setting:157.5V

GSP600-17

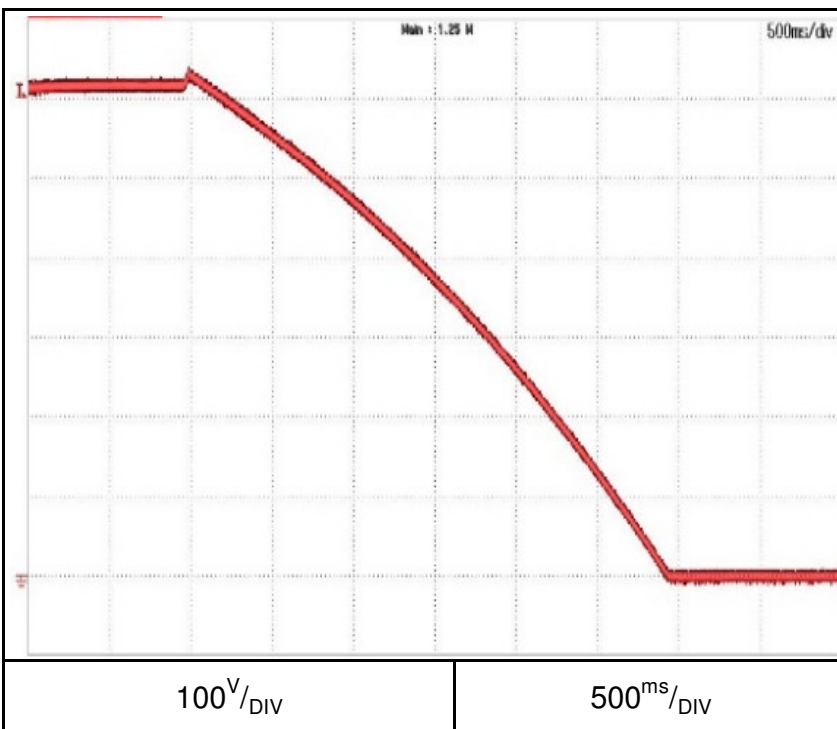

OVP setting:630V

2.4 ON/OFF Output rise characteristics

C.V mode

Conditions: Vin:Nominal

Vout: 100%

Iout: 0%

Iset=105%

Ta = 25°C

GSP10-1000

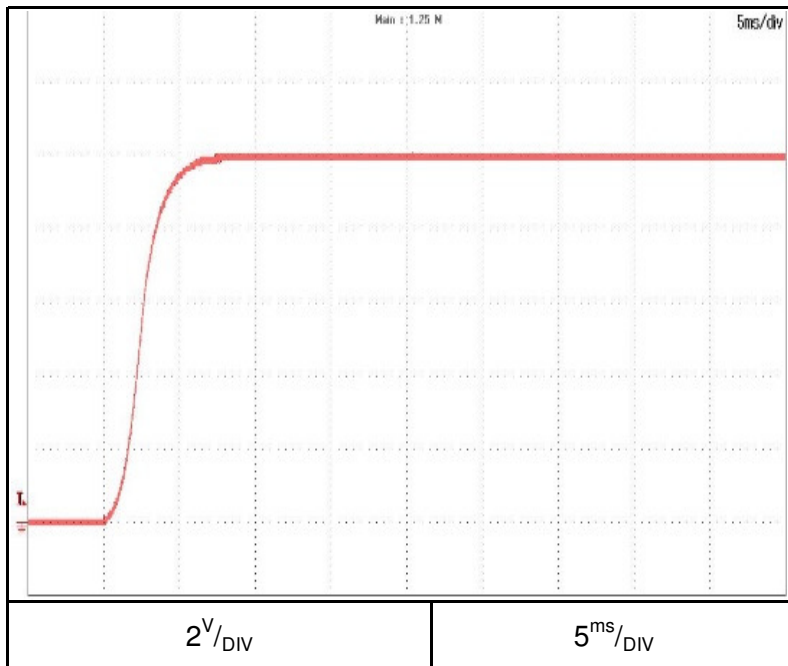

GSP60-170

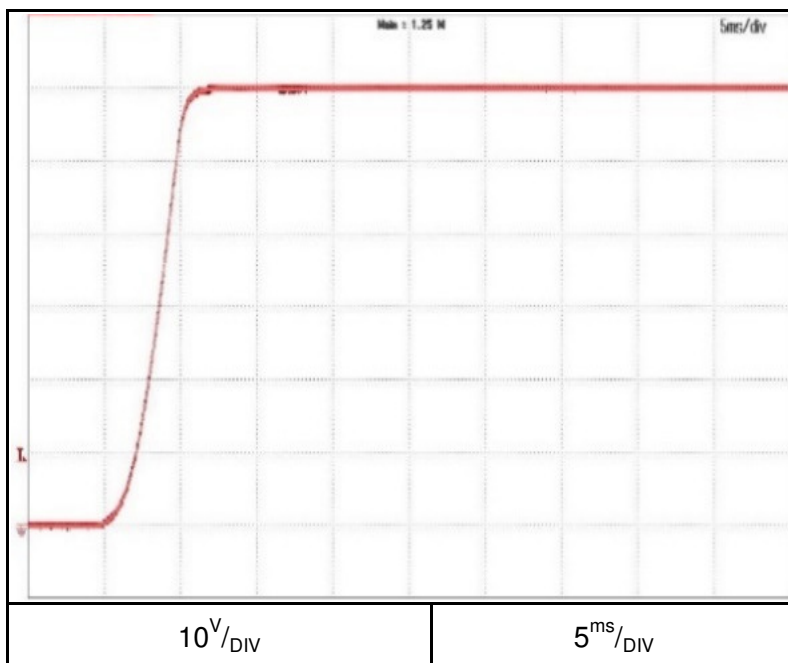

2.4 ON/OFF Output rise characteristics

C.V mode

Conditions: Vin:Nominal

Vout: 100%

Iout: 0%

Iset=105%

Ta = 25 °C

GSP150-68

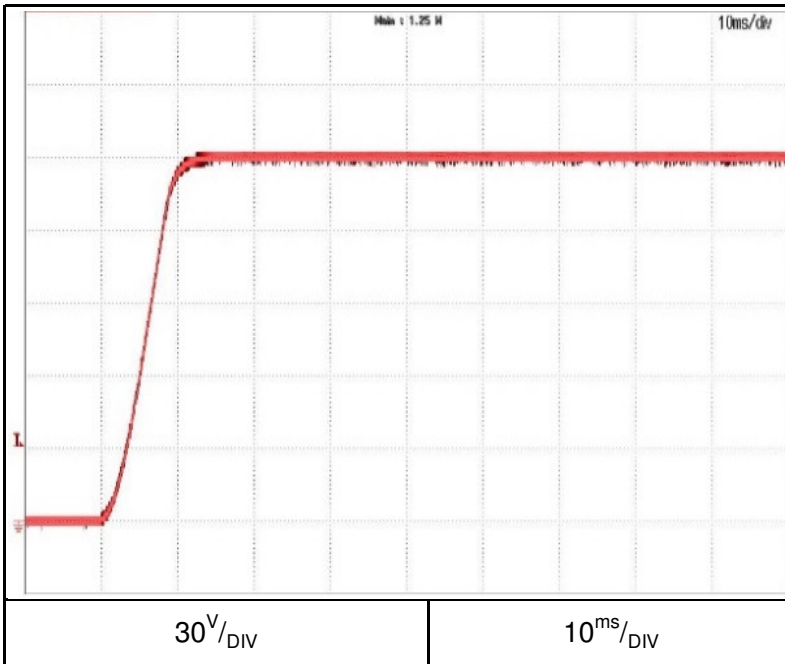

GSP600-17

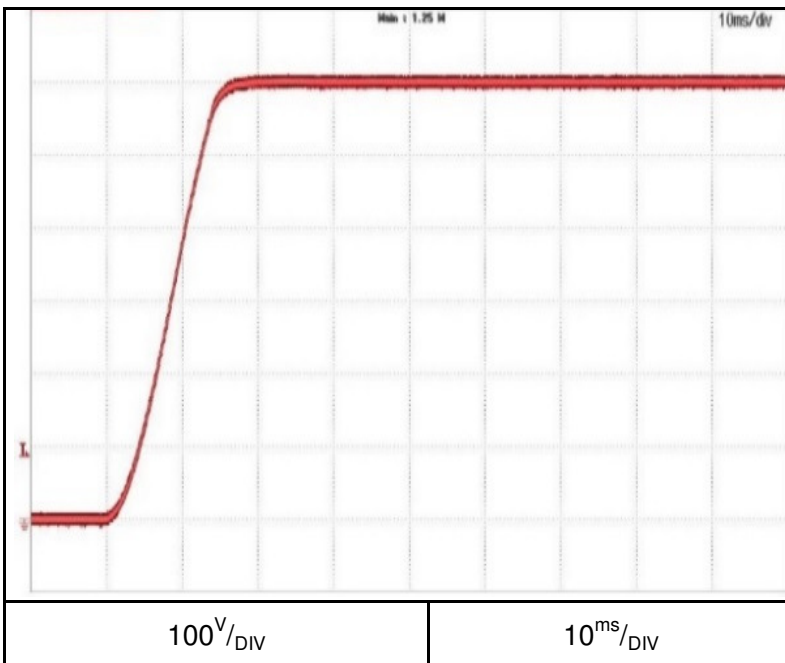

2.4 ON/OFF Output rise characteristics C.V mode

Conditions: Vin:Nominal
Vout: 100%
Iout: 100%
Iset=105%
Load: CR
Ta = 25°C

GSP10-1000

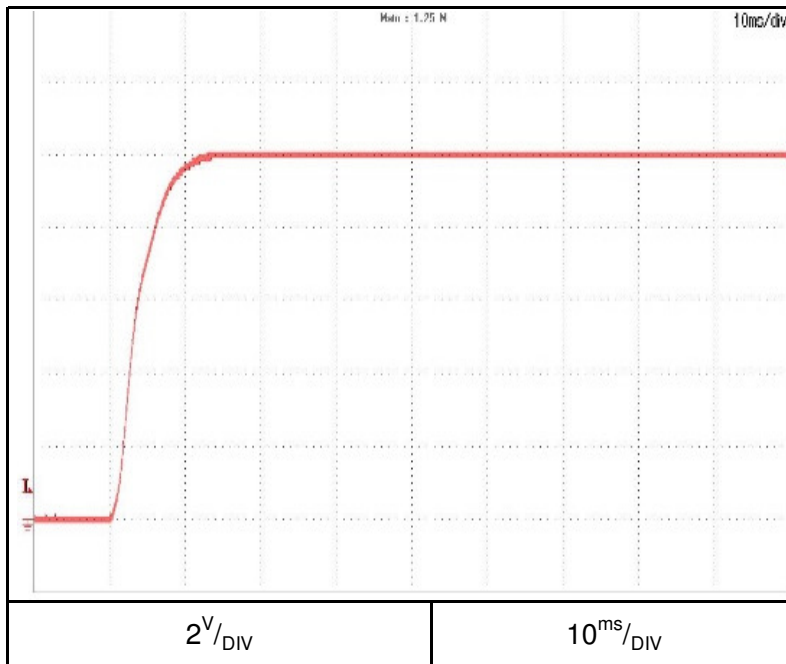

GSP60-170

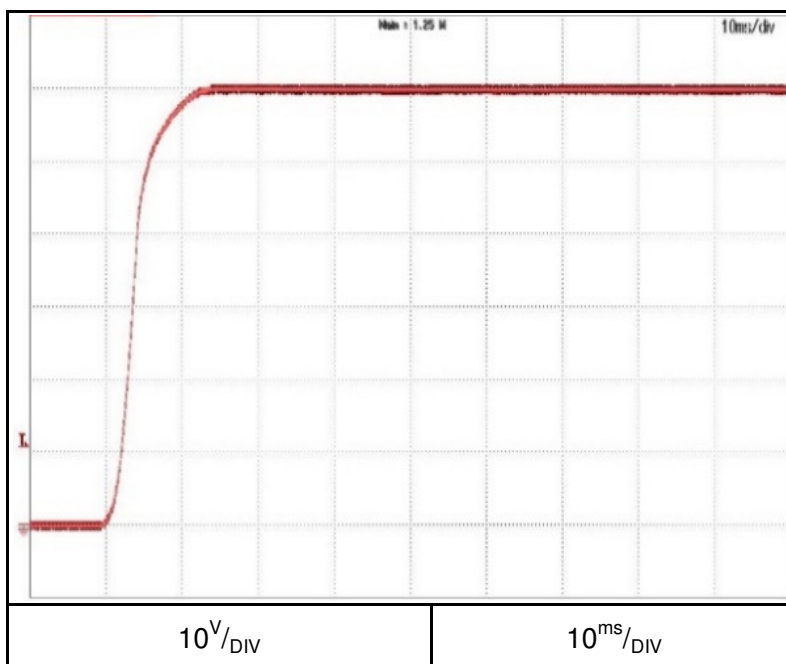

2.4 ON/OFF Output rise characteristics
C.V mode

Conditions: Vin:Nominal
Vout: 100%
Iout: 100%
Iset=105%
Load: CR
Ta = 25°C

GSP150-68

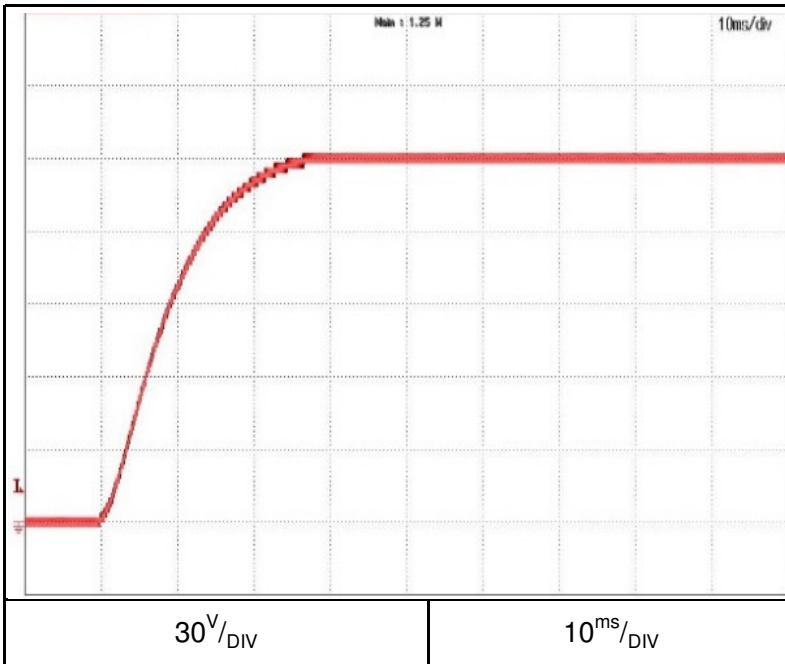

GSP600-17

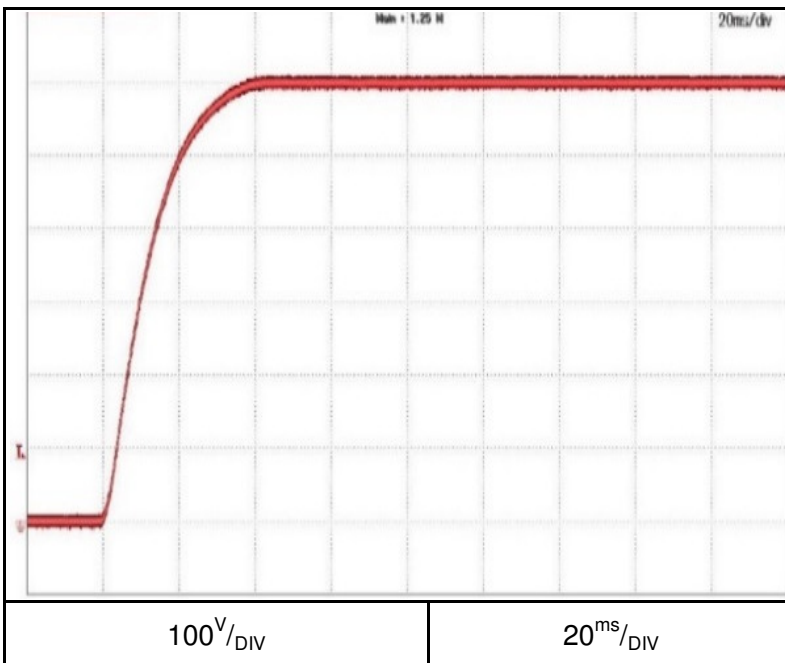

2.4 ON/OFF Output rise characteristics C.C mode

Conditions: Vin:Nominal
Vout: 100%
Iout: 100%
Vset=105%
Load: CR
Ta = 25°C

GSP10-1000

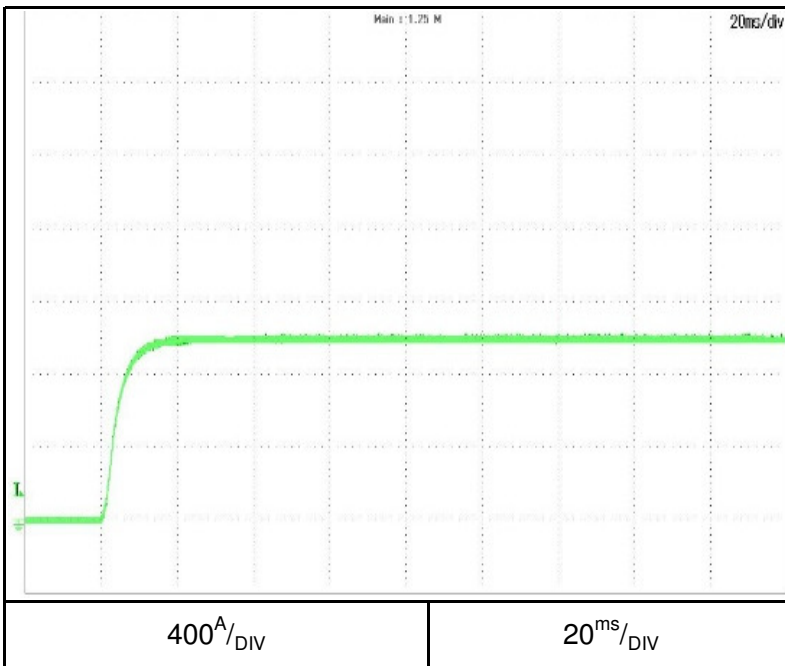

GSP60-170

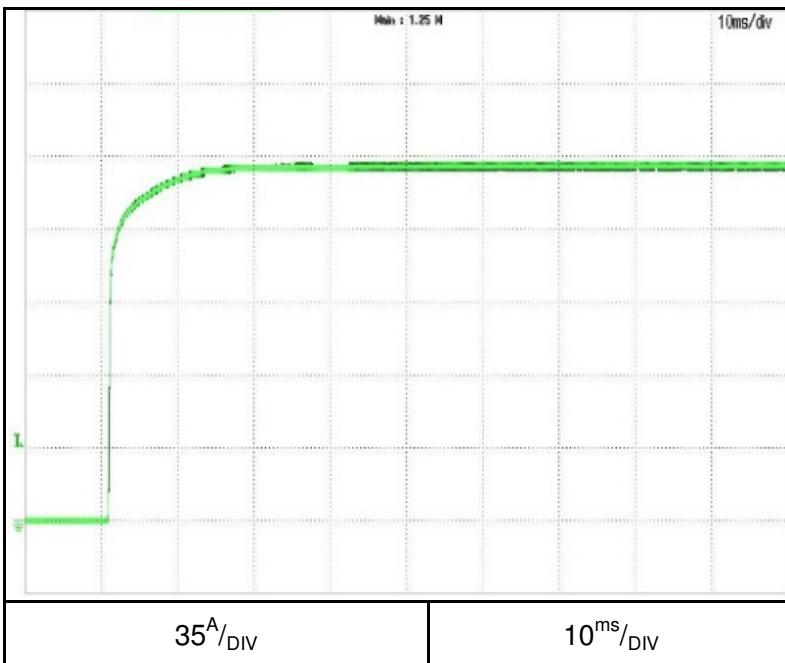

2.4 ON/OFF Output rise characteristics

C.C mode

Conditions: Vin:Nominal

Vout: 100%

Iout: 100%

Vset=105%

Load: CR

Ta = 25°C

GSP150-68

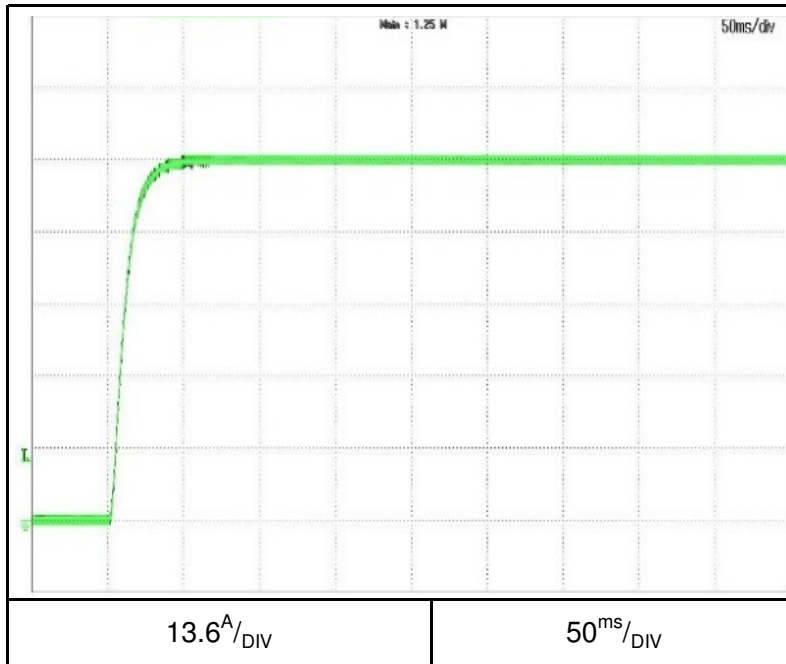

GSP600-17

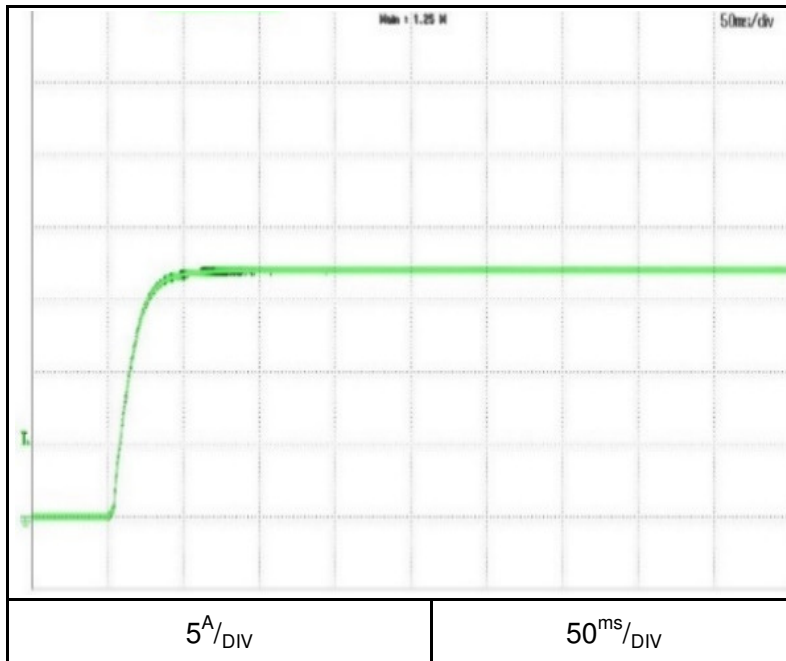

2.4 ON/OFF Output rise characteristics

C.C mode

Conditions: Vin:Nominal
Iout: 100%
Vset=105%
shorted output
Ta = 25°C

GSP10-1000

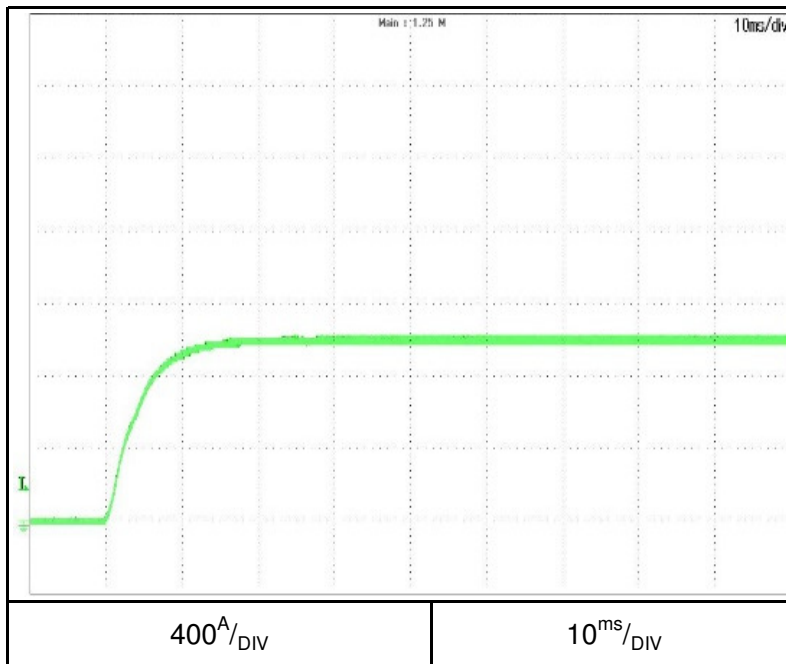

GSP60-170

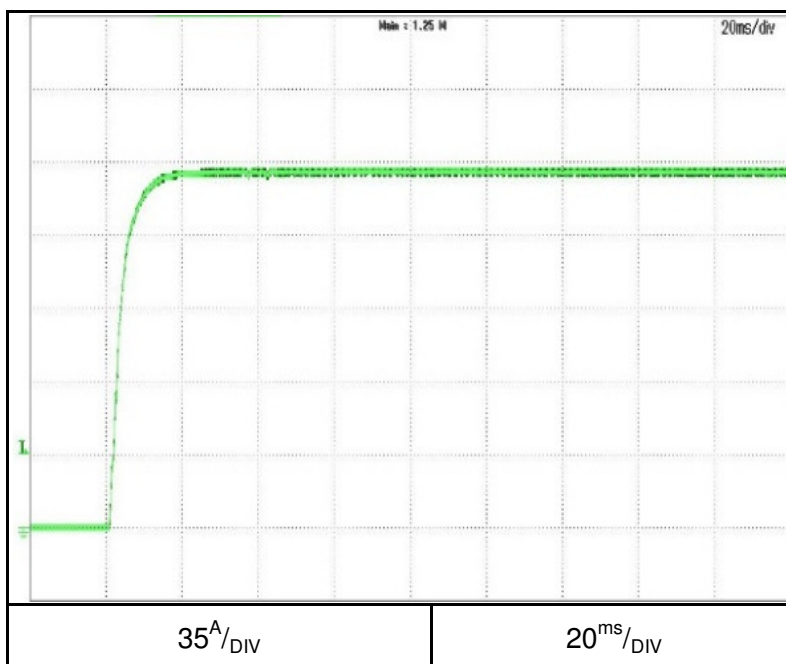

2.4 ON/OFF Output rise characteristics

C.C mode

Conditions: V_{in} :Nominal
 I_{out} : 100%
 V_{set} =105%
shorted output
 $T_a = 25^\circ\text{C}$

GSP150-68

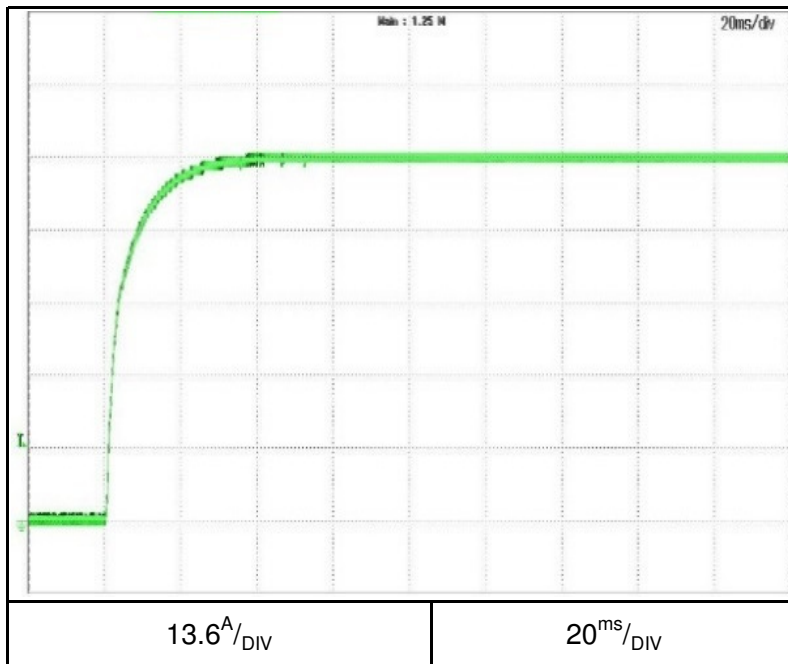

GSP600-17

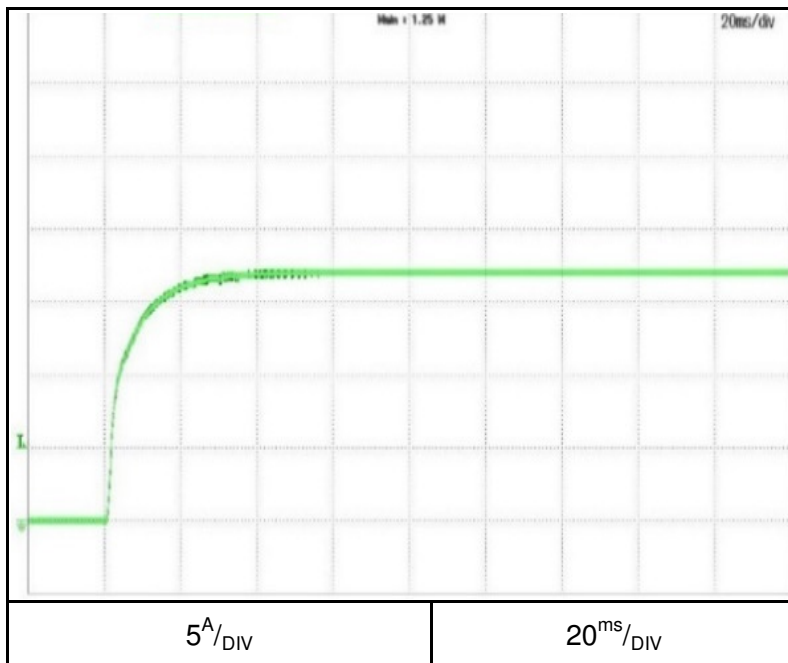

2.5 ON/OFF Output fall characteristics

C.V mode

Conditions: Vin:Nominal

Vout: 100%

Iout: 0%

Ta = 25°C

GSP10-1000

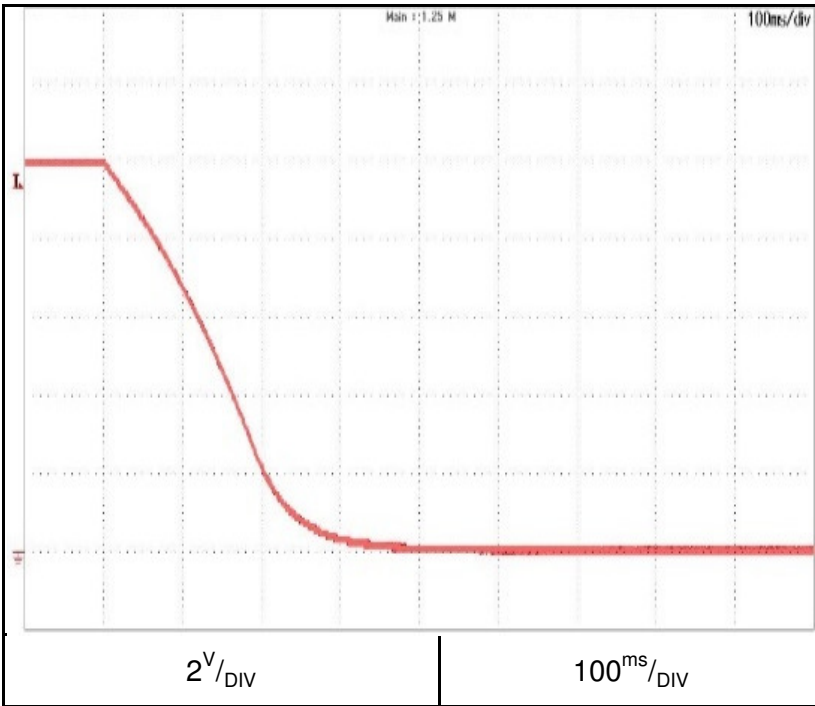

GSP60-170

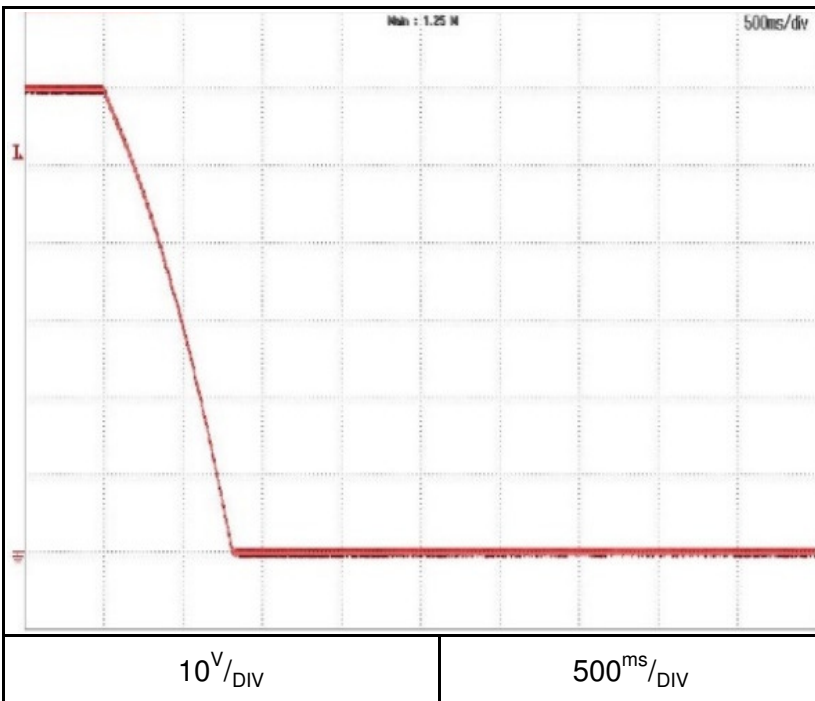

2.5 ON/OFF Output fall characteristics

C.V mode

Conditions: Vin:Nominal

Vout: 100%

Iout: 0%

Ta = 25°C

GSP150-68

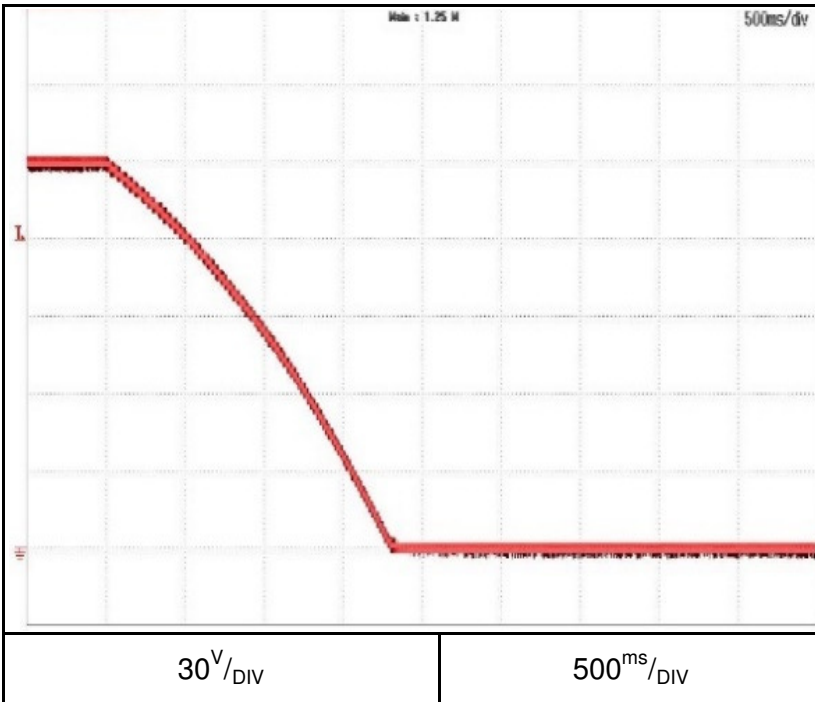

GSP600-17

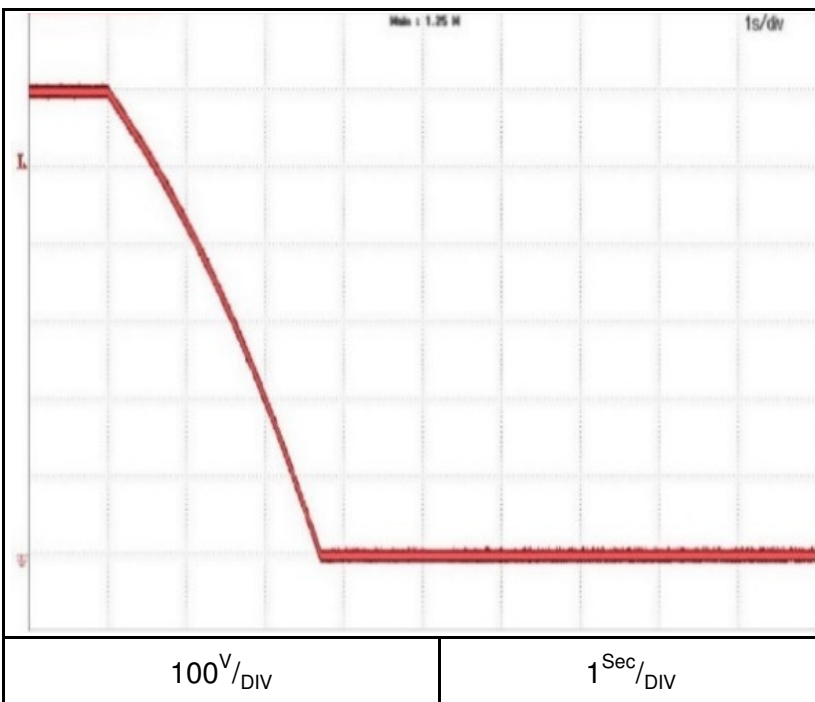

2.5 ON/OFF Output fall characteristics

C.V mode

Conditions: Vin:Nominal

Vout: 100%

Iout: 100%

Load: CR

Ta = 25°C

GSP10-1000

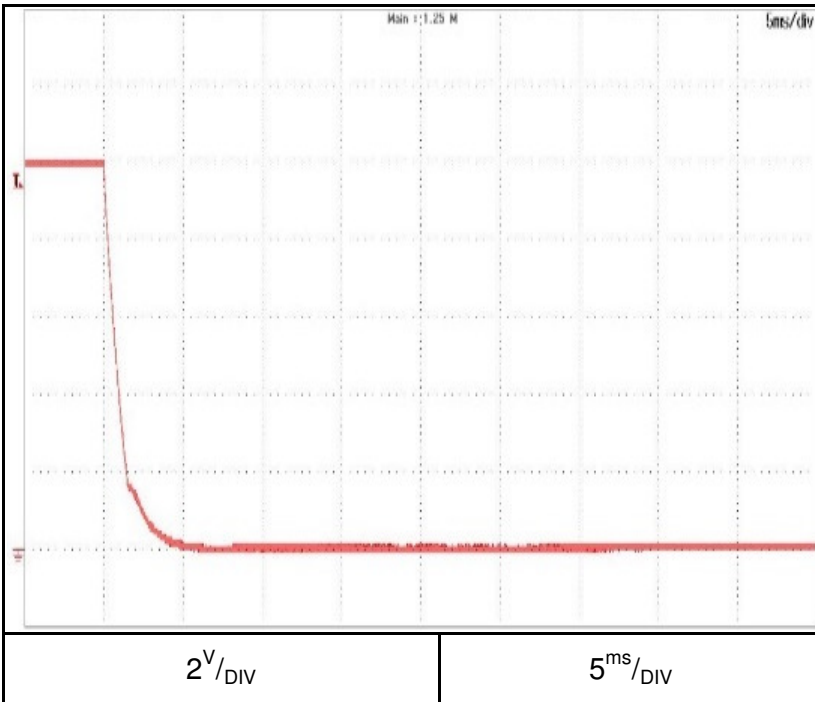

GSP60-170

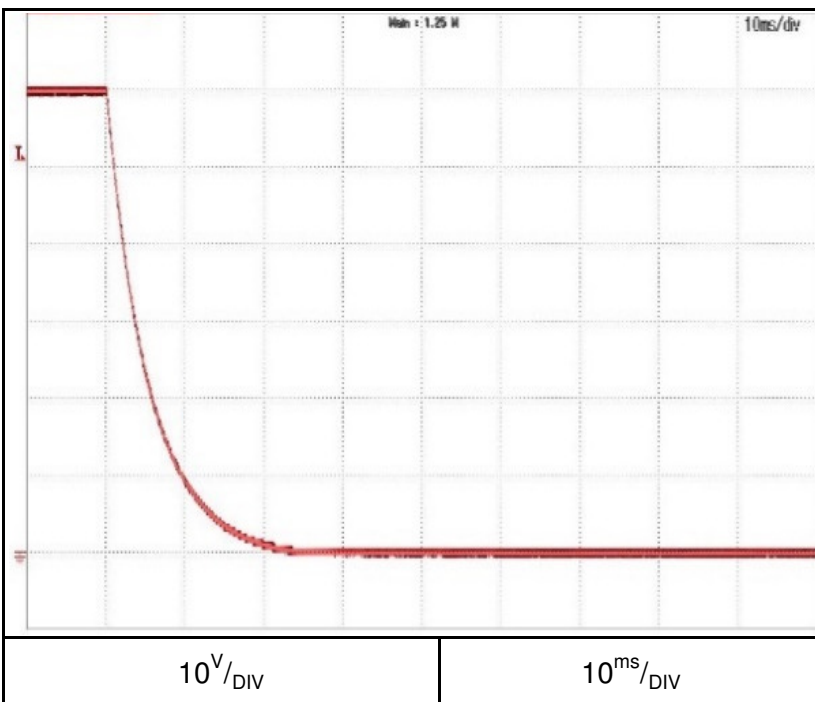

2.5 ON/OFF Output fall characteristics

C.V mode

Conditions: Vin:Nominal

Vout: 100%

Iout: 100%

Load: CR

Ta = 25°C

GSP150-68

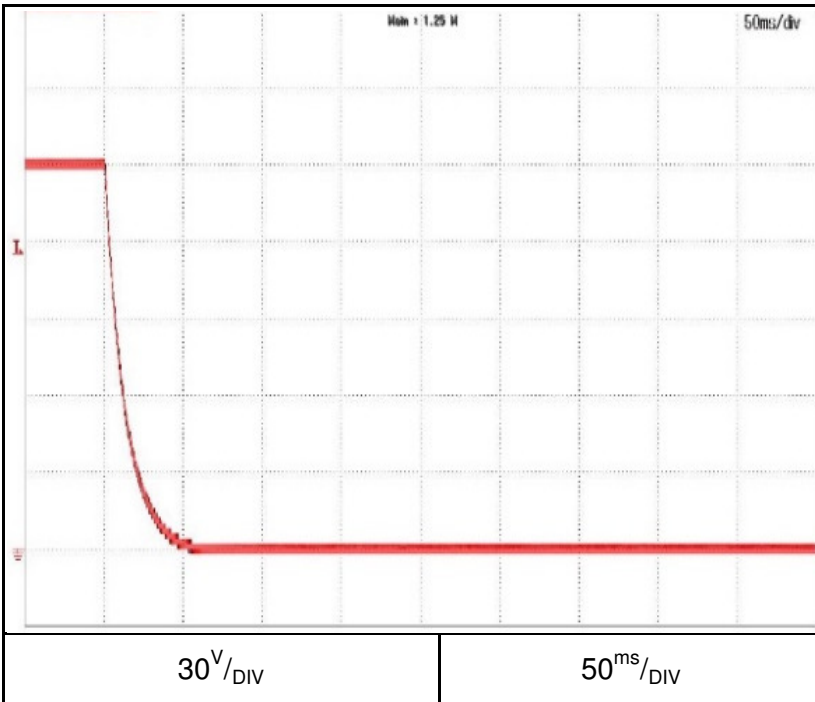

GSP600-17

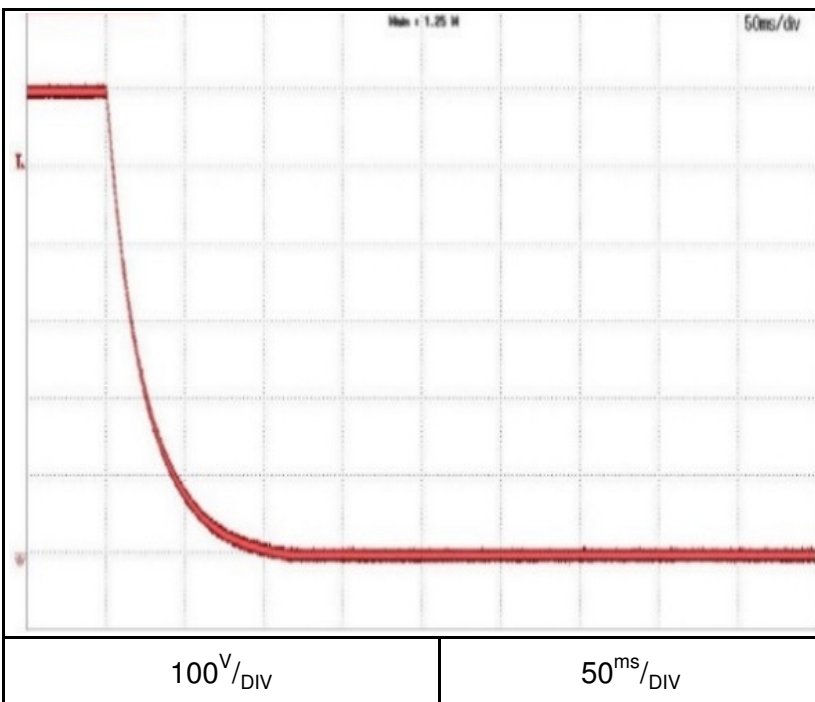

2.5 ON/OFF Output fall characteristics

C.C mode

Conditions: Vin:Nominal

Vout: 100%

Iout: 100%

Load: CR

Ta = 25°C

GSP10-1000

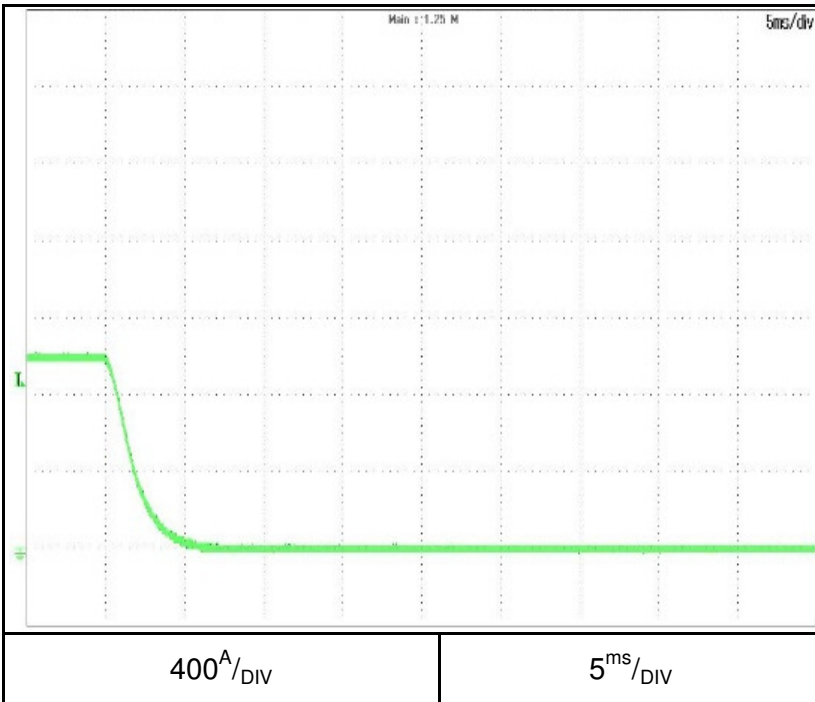

GSP60-170

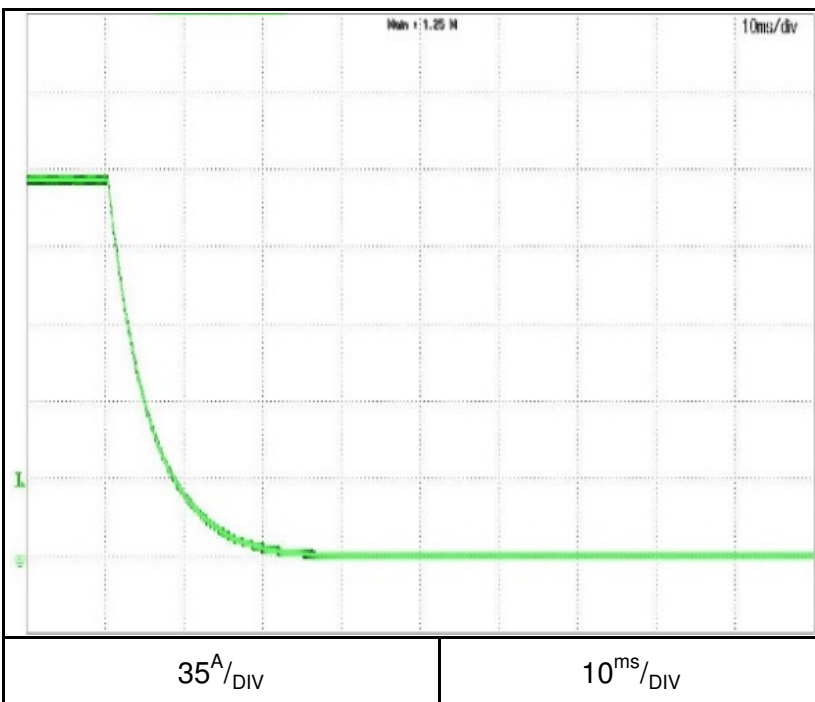

2.5 ON/OFF Output fall characteristics

C.C mode

Conditions: Vin:Nominal

Vout: 100%

Iout: 100%

Load: CR

Ta = 25°C

GSP150-68

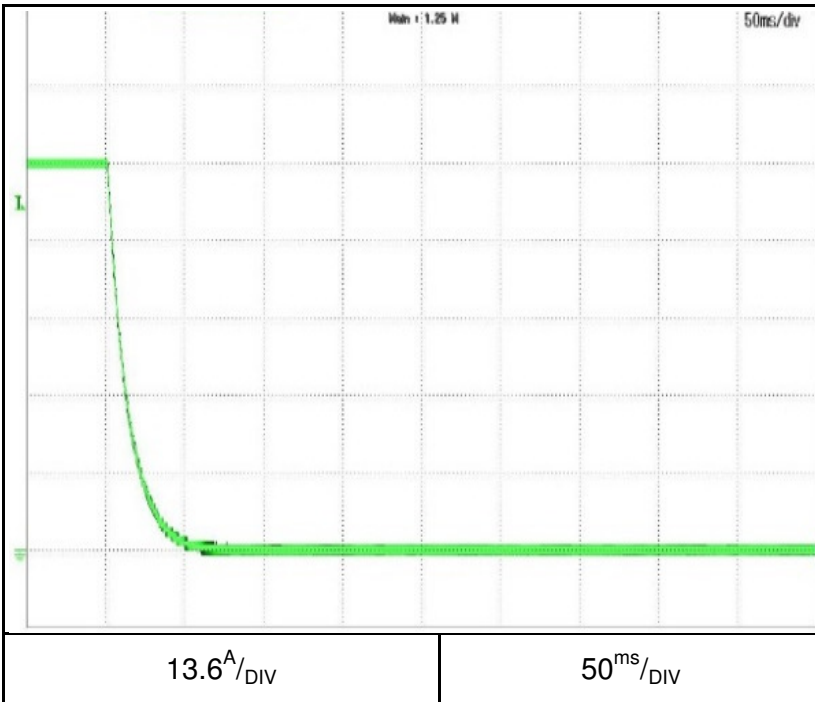

GSP600-17

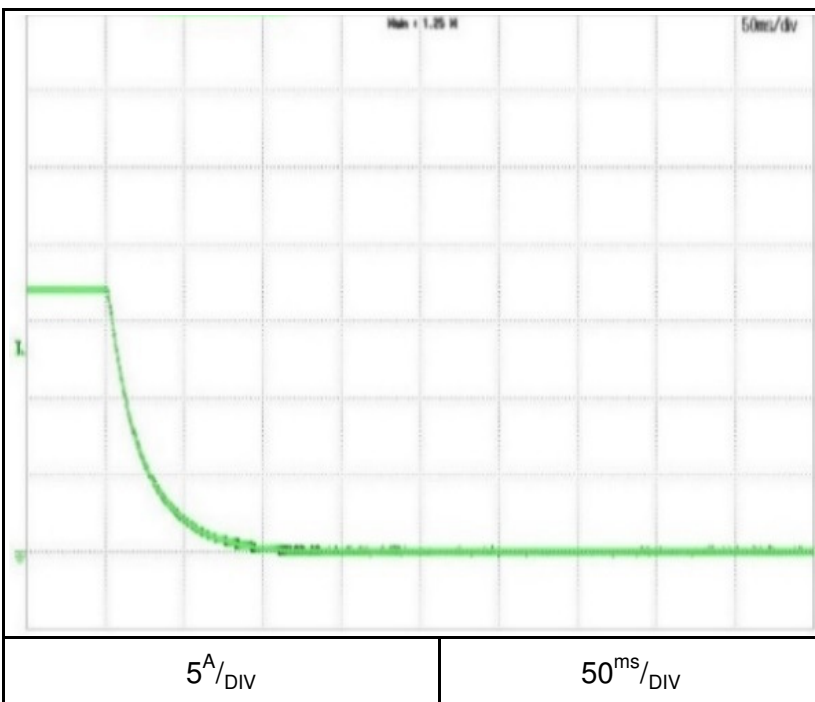

2.5 ON/OFF Output fall characteristics

C.C mode

Conditions: Vin:Nominal
Iout: 100%
shorted output
Ta = 25°C

GSP10-1000

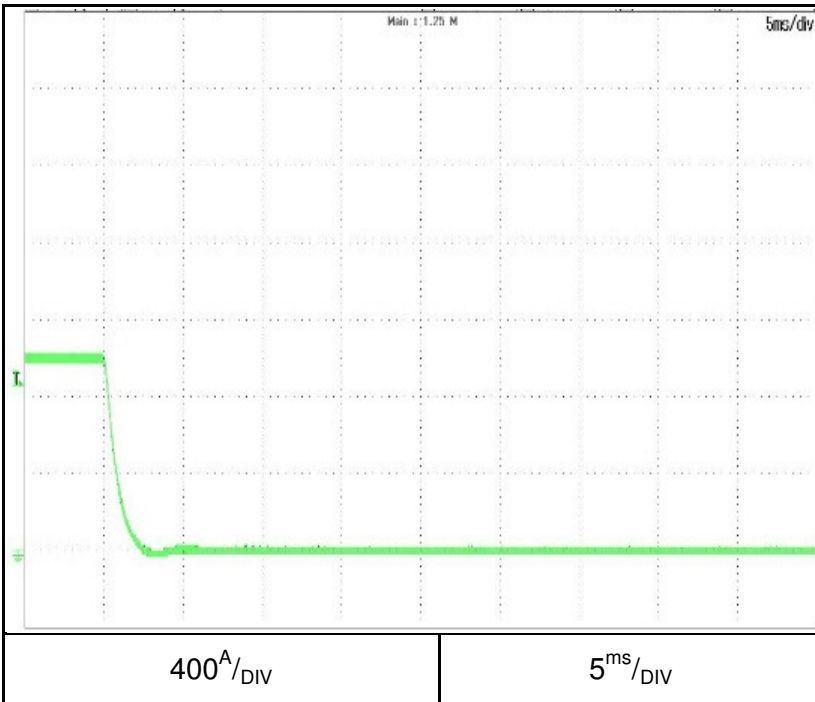

GSP60-170

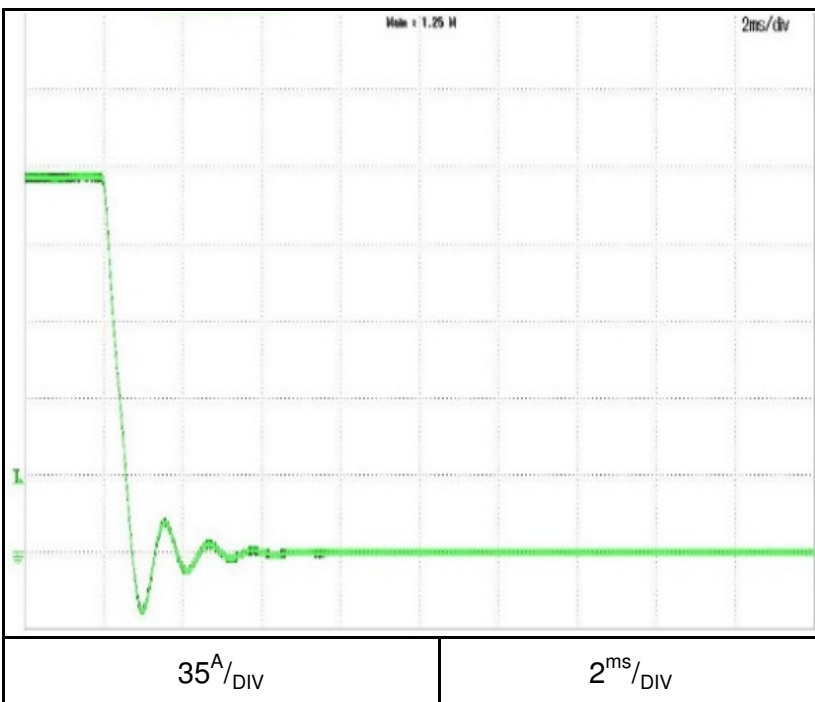

2.5 ON/OFF Output fall characteristics

C.C mode

Conditions: V_{in} :Nominal
I_{out}: 100%
shorted output
T_a = 25 °C

GSP150-68

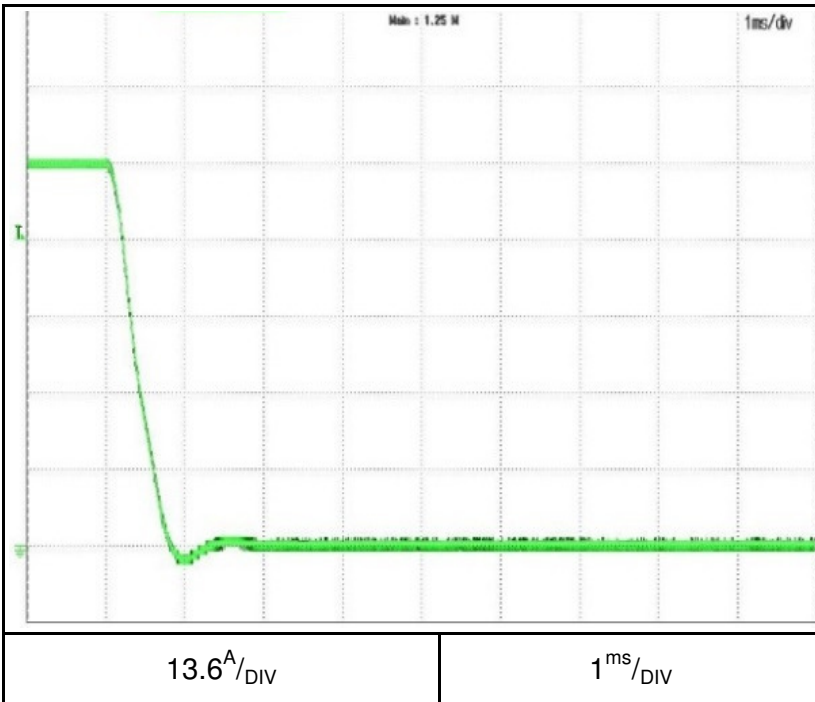

GSP600-17

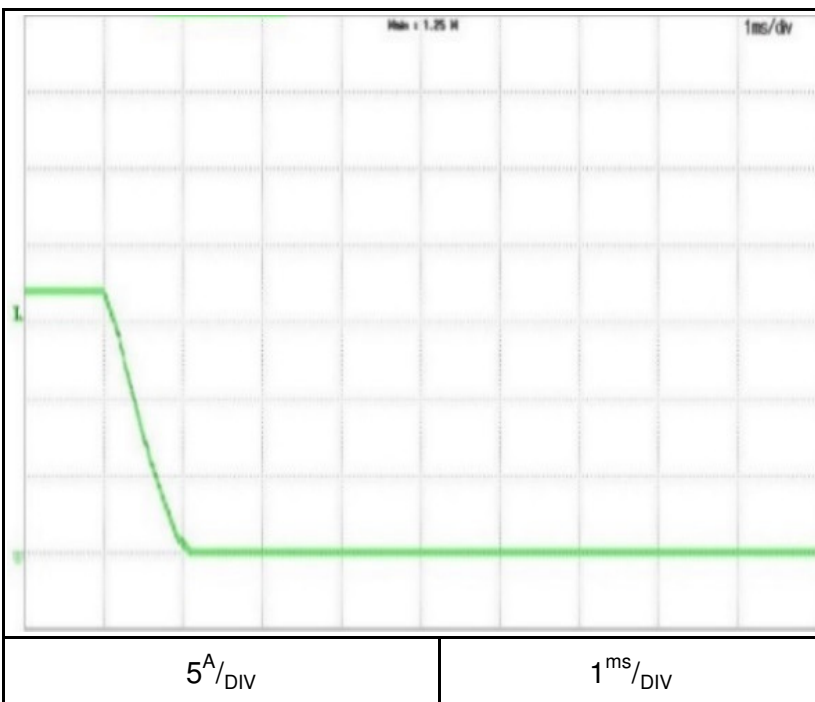

2.6 Holdup time characteristics

Conditions: $T_a = 25^\circ\text{C}$

$V_{out}: 100\%$

GSP10-1000 3 Φ 200

$V_{in}: 200\text{VAC}$

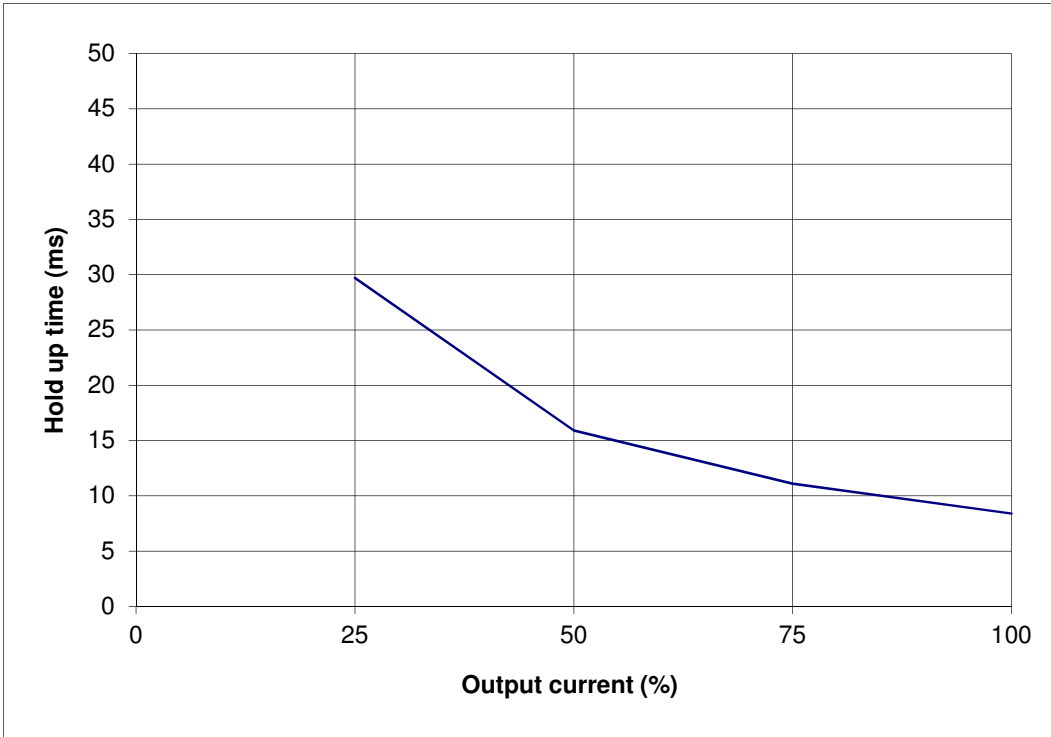

GSP10-1000 3 Φ 400

$V_{in}: 400\text{VAC}$

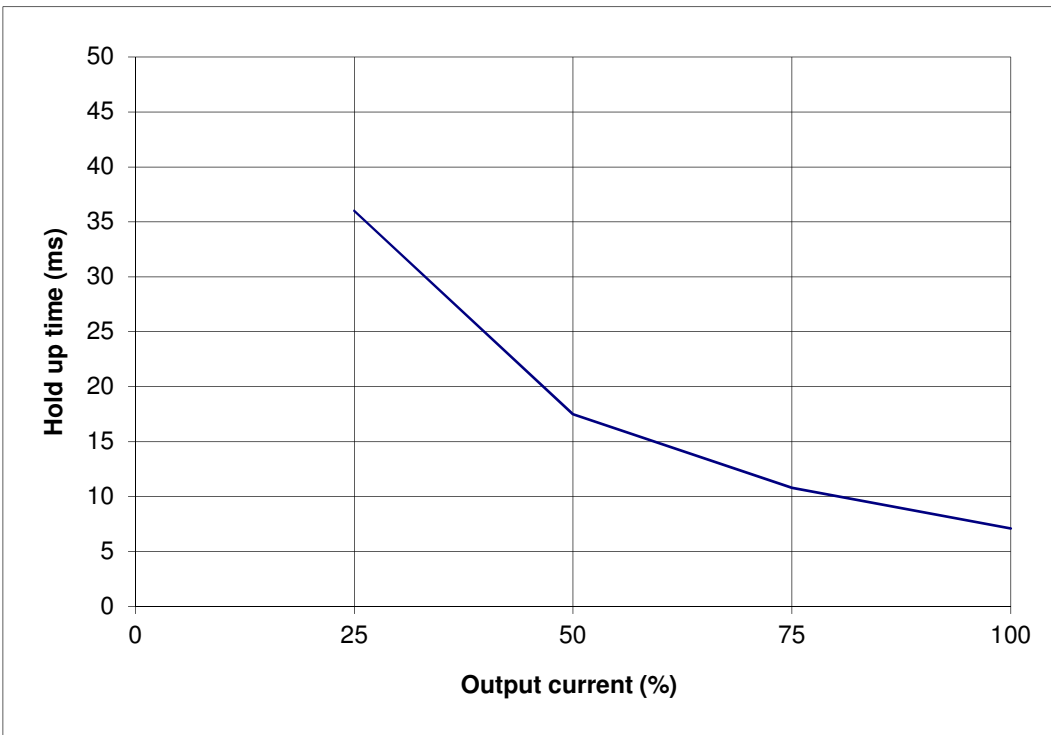

2.6 Holdup time characteristics

Conditions: $T_a = 25^\circ\text{C}$
 $V_{out}: 100\%$

GSP10-1000 3 Φ 480

$V_{in}: 480\text{VAC}$

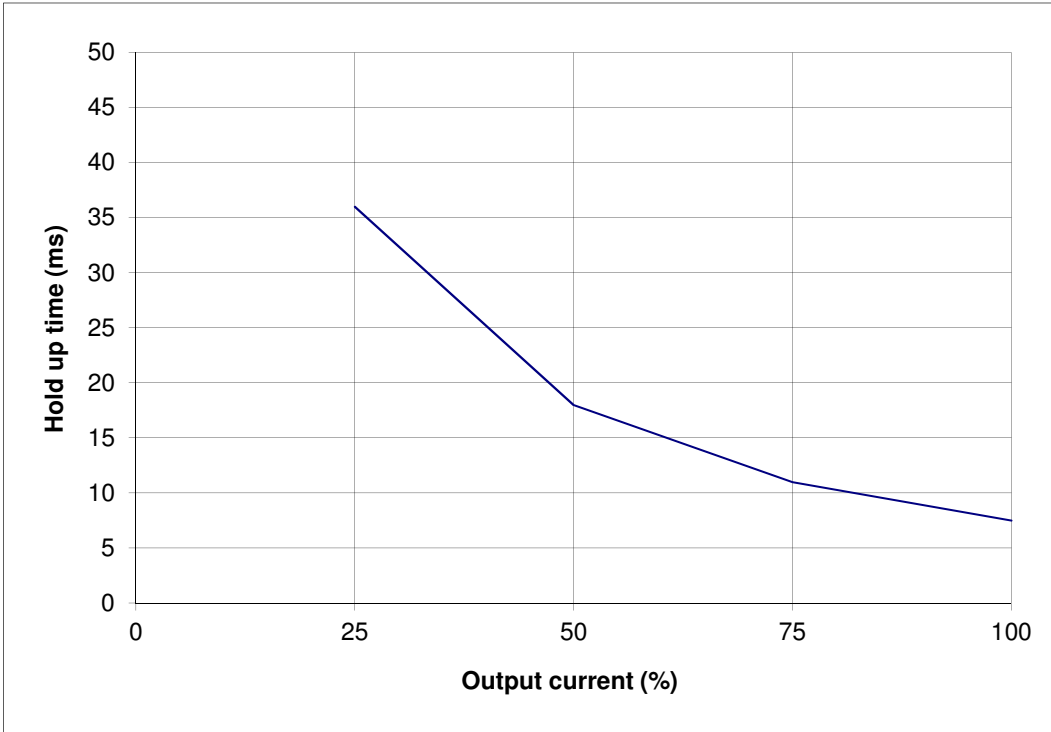

2.6 Holdup time characteristics

Conditions: $T_a = 25^\circ\text{C}$

$V_{out}: 100\%$

GSP600-17 3 Φ 200

$V_{in}: 230\text{VAC}$

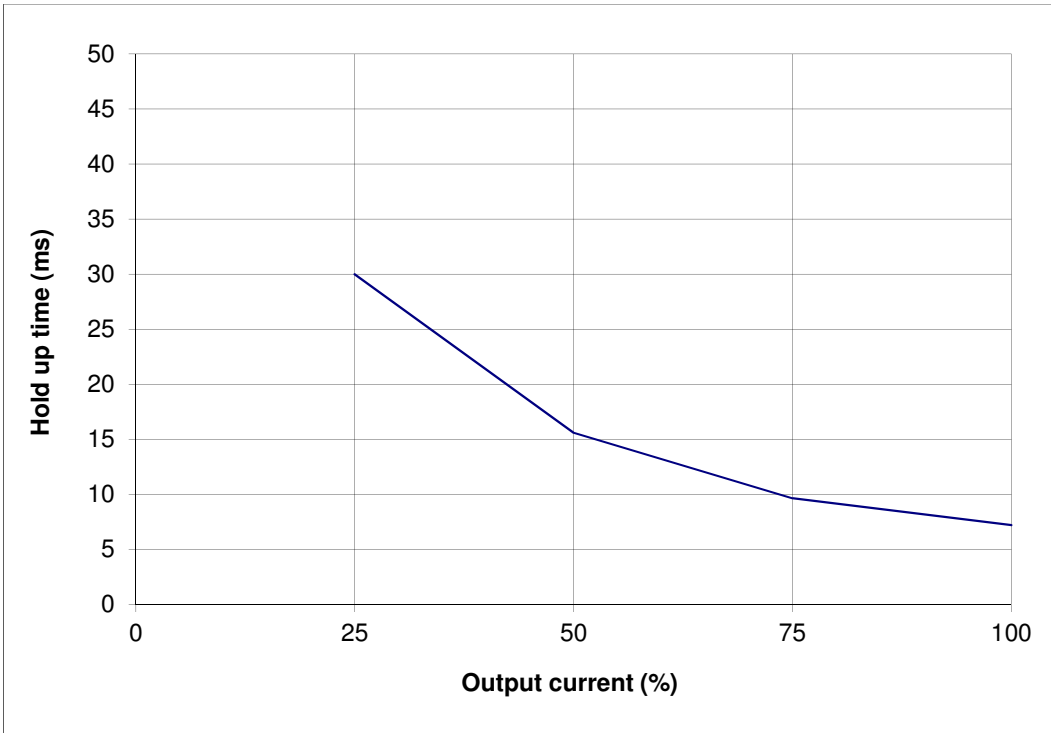

GSP600-17 3 Φ 400

$V_{in}: 400\text{VAC}$

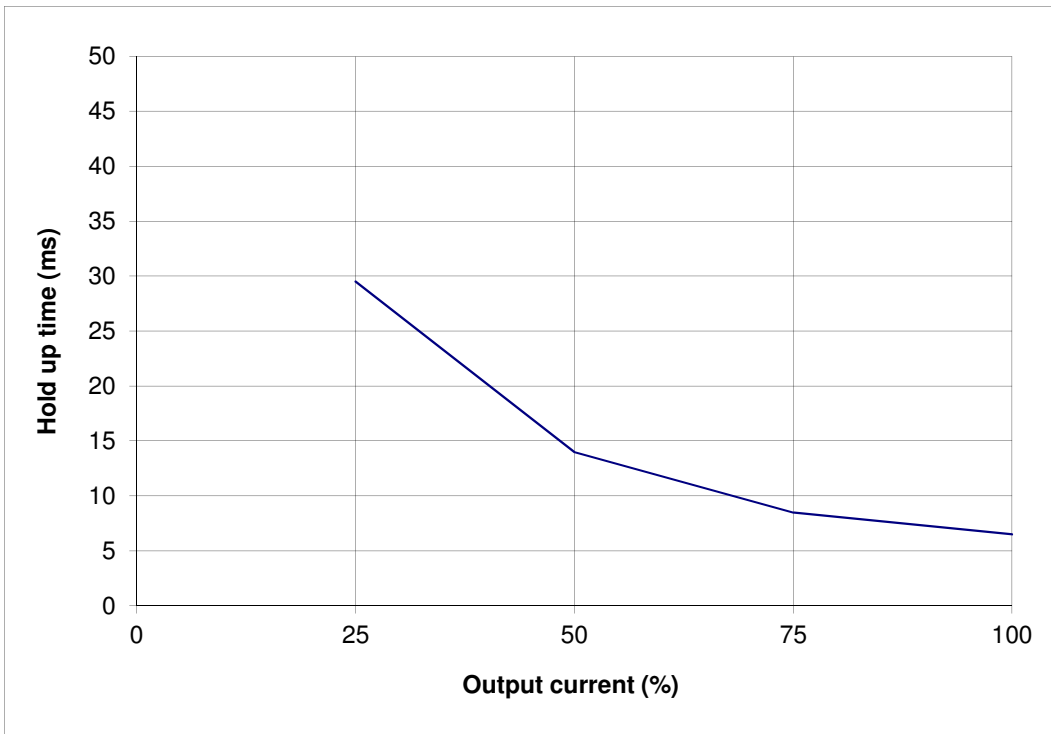

2.6 Holdup time characteristics

Conditions: $T_a = 25^\circ\text{C}$
 $V_{out}: 100\%$

GSP600-17 3 Φ 480

$V_{in}: 480\text{VAC}$

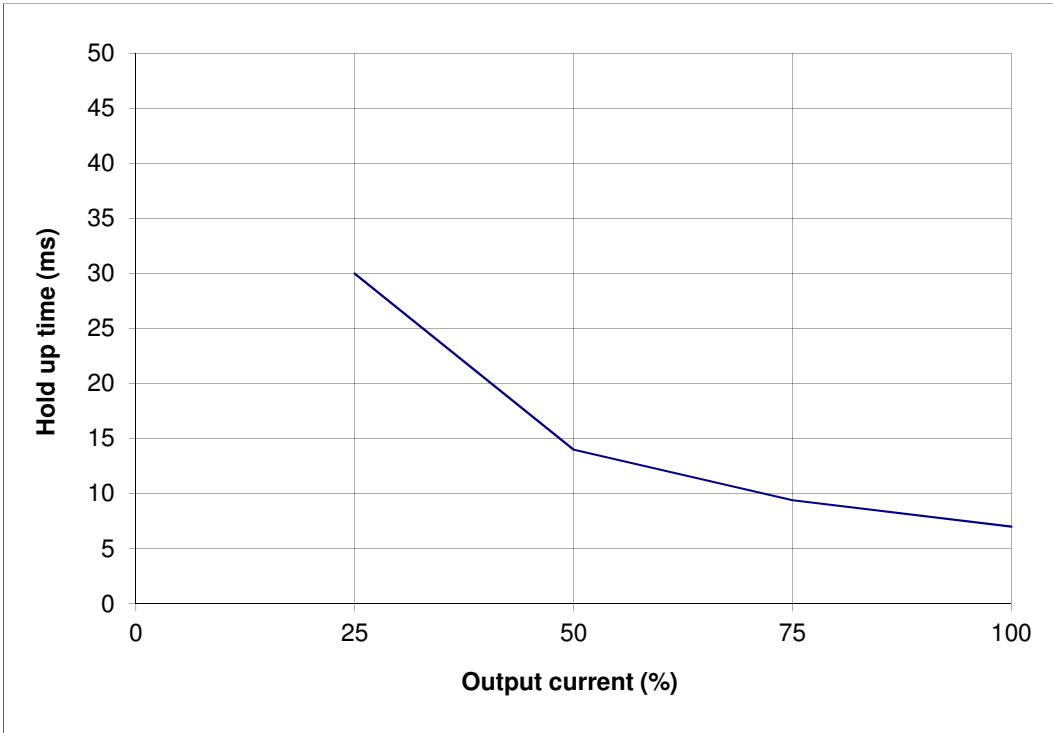

2.7 Dynamic line response characteristics

Ta = 25 °C

C.V mode

GSP10-1000 3Φ200

Conditions: Vout: 100%
Iout: 100%
Vin: 170↔265V

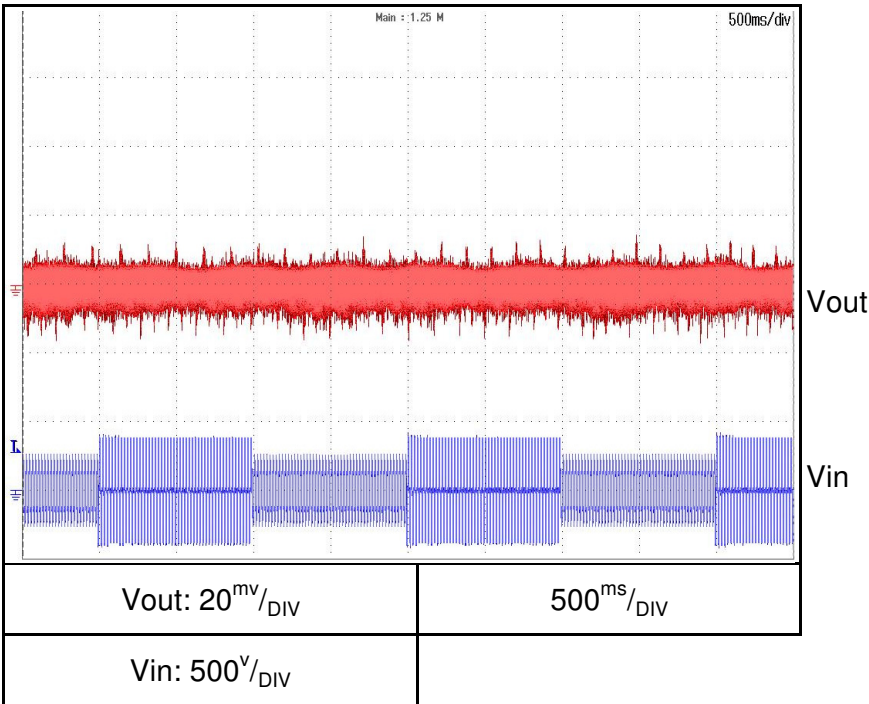

GSP10-1000 3Φ480

Conditions: Vout: 100%
Iout: 100%
Vin: 342↔520V

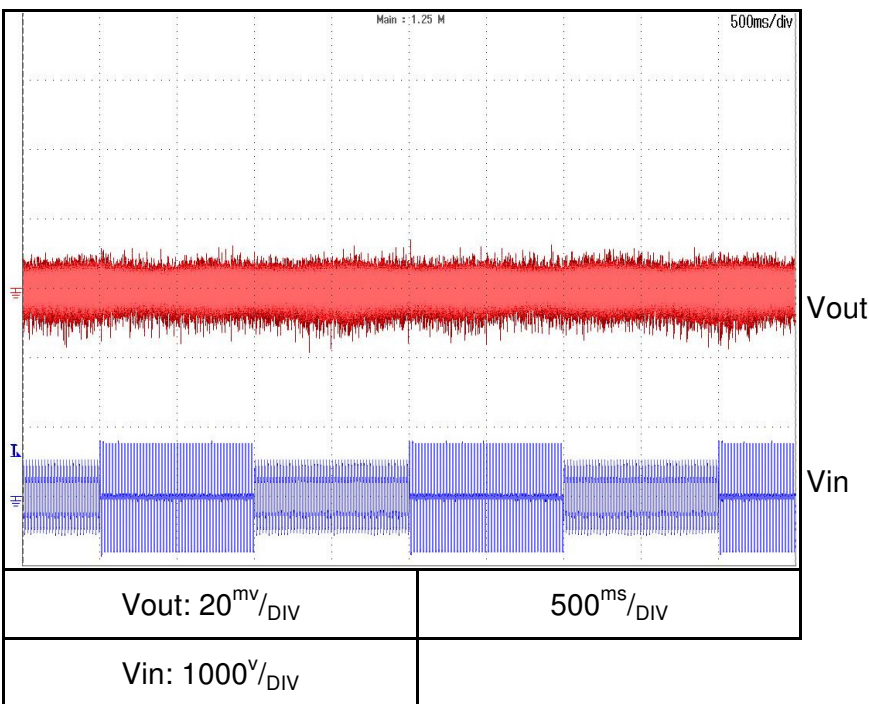

2.7 Dynamic line response characteristics
C.C mode

Ta = 25 °C

GSP10-1000 3Φ200

Conditions: Vout: 100%
Iout: 100%
Vin: 170↔265V

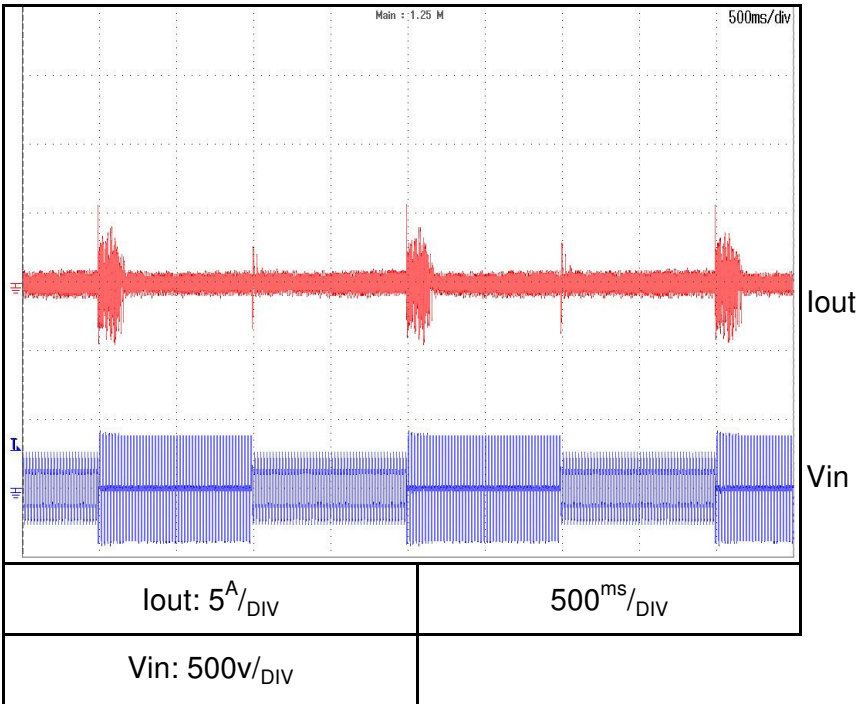

GSP10-1000 3Φ480

Conditions: Vout: 100%
Iout: 100%
Vin: 342↔520V

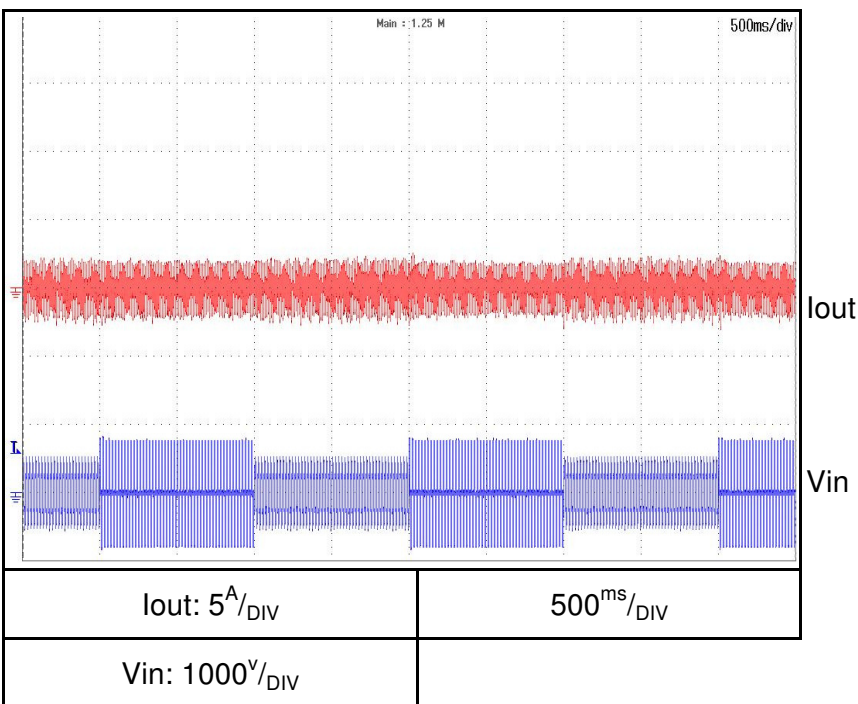

2.7 Dynamic line response characteristics

Ta = 25 °C

C.V mode

GSP60-170 3Φ400

Conditions: Vout: 100%
Iout: 100%
Vin: 342↔460V

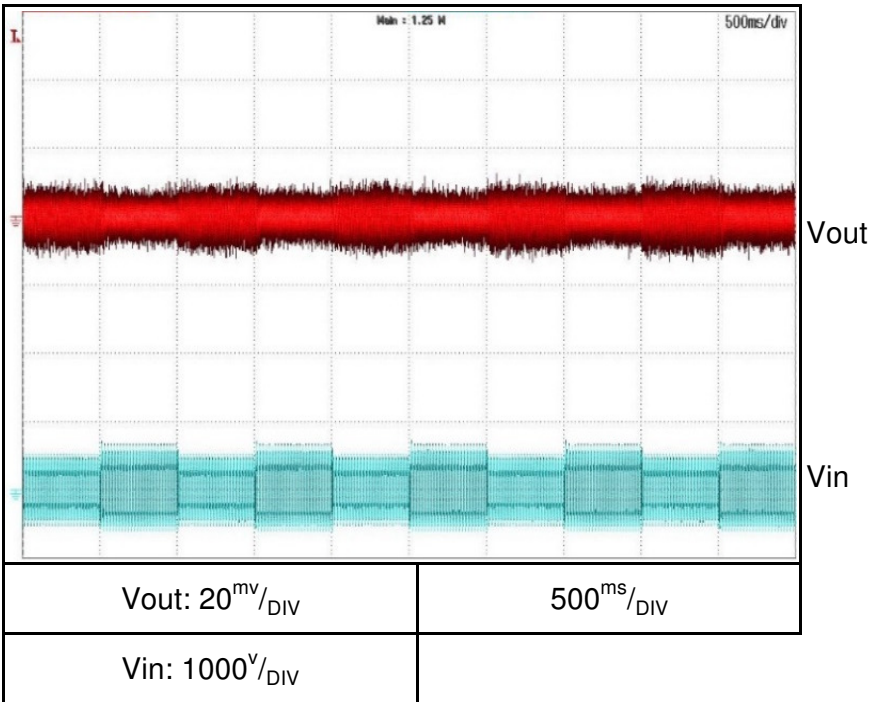

2.7 Dynamic line response characteristics

Ta = 25 °C

C.C mode

GSP60-170 3Φ400

Conditions: Vout: 100%
Iout: 100%
Vin: 342↔460V

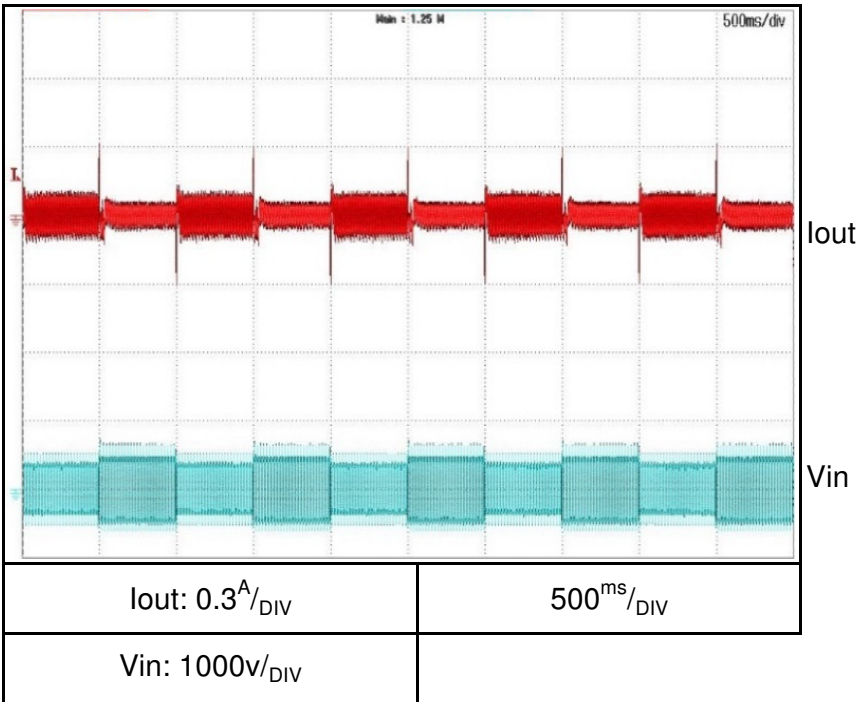

2.7 Dynamic line response characteristics

C.V mode

Ta = 25°C

GSP150-68 3Φ200

Conditions: Vout: 100%
Iout: 100%
Vin: 170↔265V

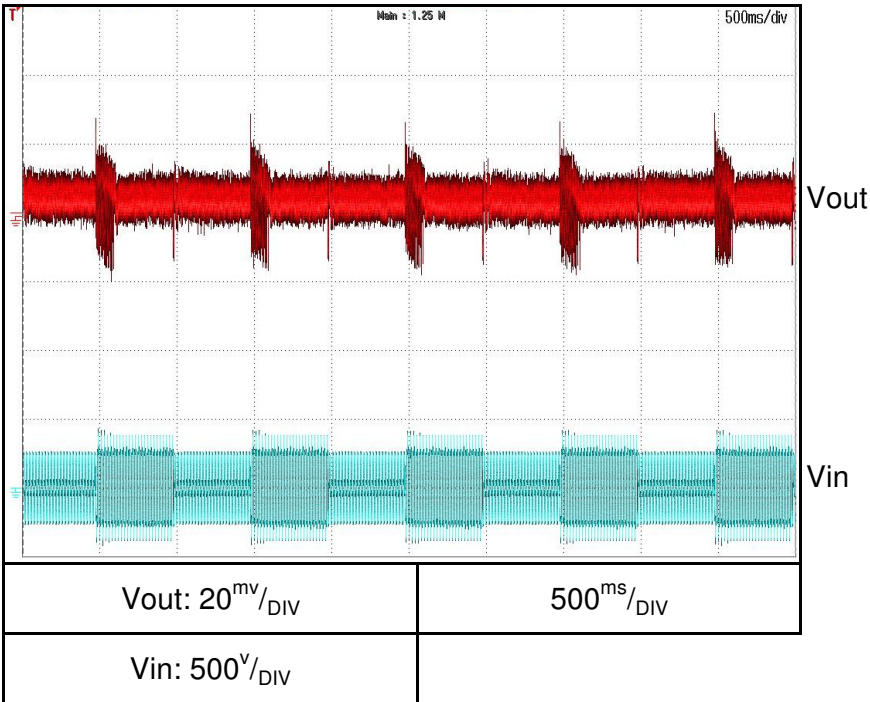

2.7 Dynamic line response characteristics

C.C mode

Ta = 25 °C

GSP150-68 3Φ200

Conditions: Vout: 100%
Iout: 100%
Vin: 170↔265V

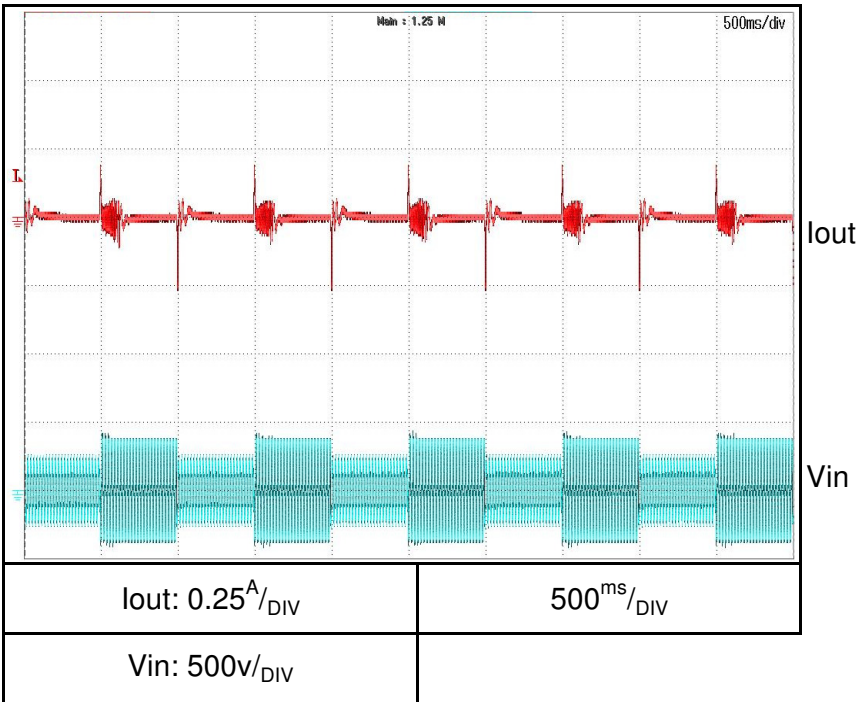

2.7 Dynamic line response characteristics

Ta = 25 °C

C.V mode

GSP600-17 3Φ200

Conditions: Vout: 100%
Iout: 100%
Vin: 170↔265V

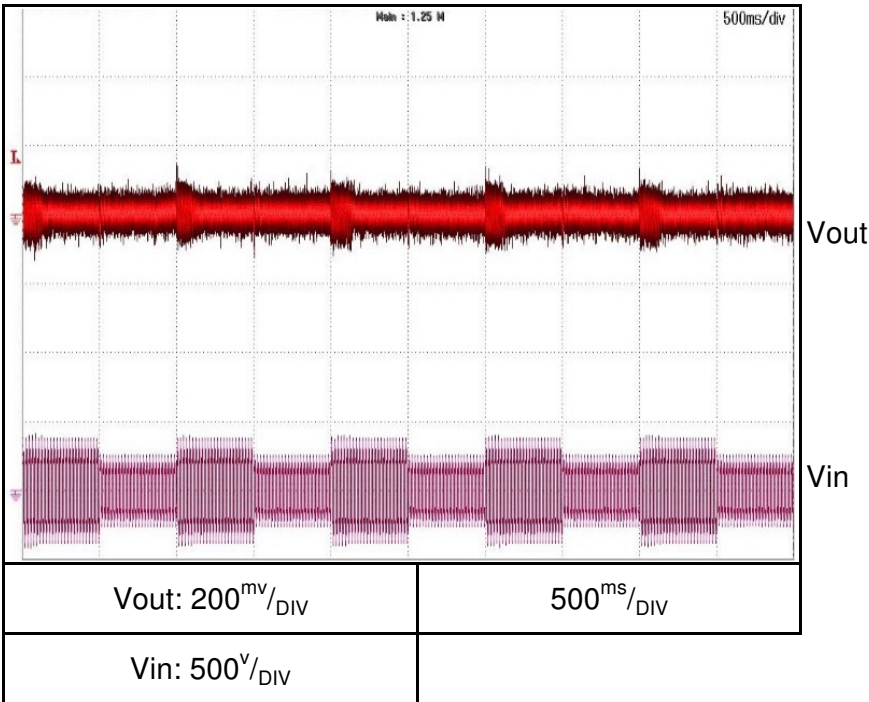

GSP600-17 3Φ400

Conditions: Vout: 100%
Iout: 100%
Vin: 342↔460V

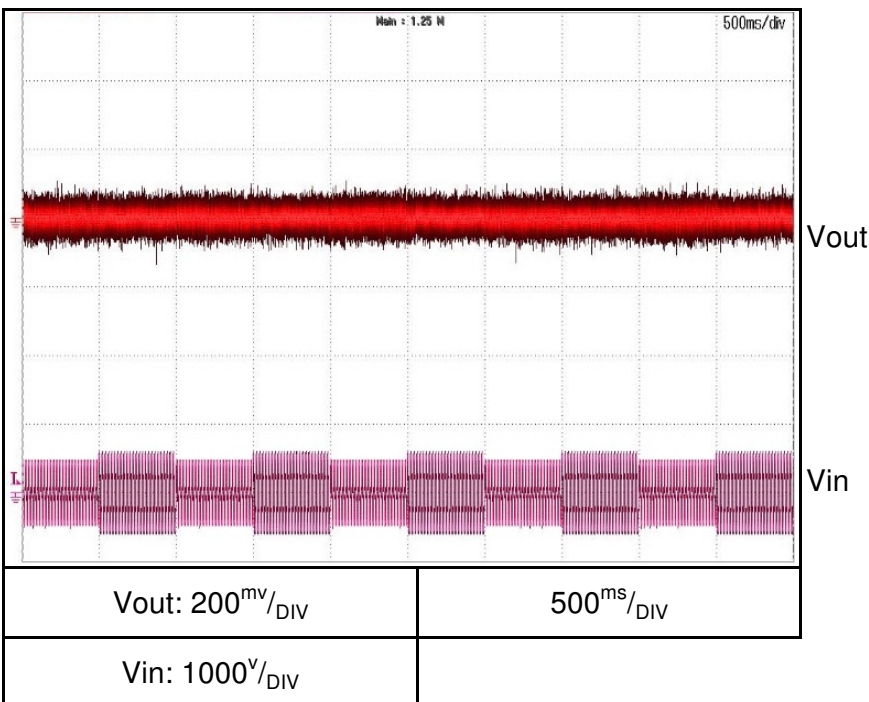

2.7 Dynamic line response characteristics

Ta = 25°C

C.V mode

GSP600-17 3Φ480

Conditions: Vout: 100%
Iout: 100%
Vin: 342↔520V

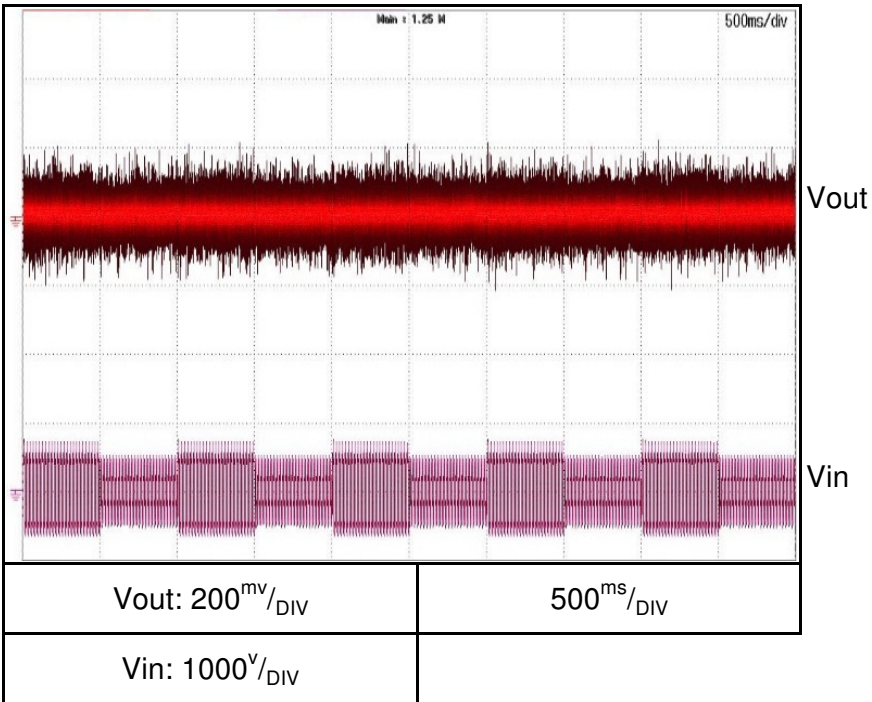

2.7 Dynamic line response characteristics

Ta = 25 °C

C.C mode

GSP600-17 3Φ200

Conditions: Vout: 100%
Iout: 100%
Vin: 170↔265V

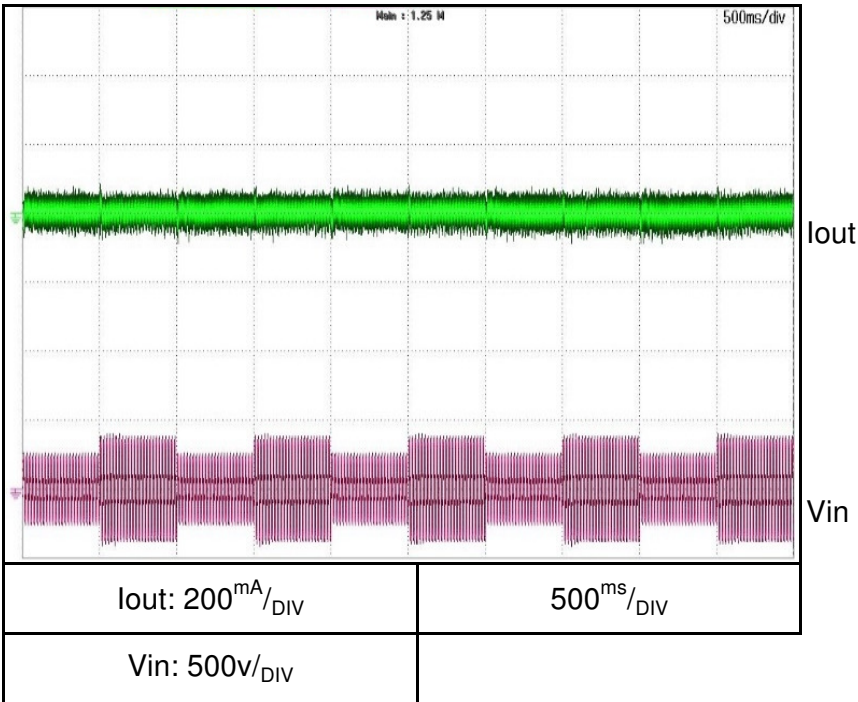

GSP600-17 3Φ400

Conditions: Vout: 100%
Iout: 100%
Vin: 342↔460V

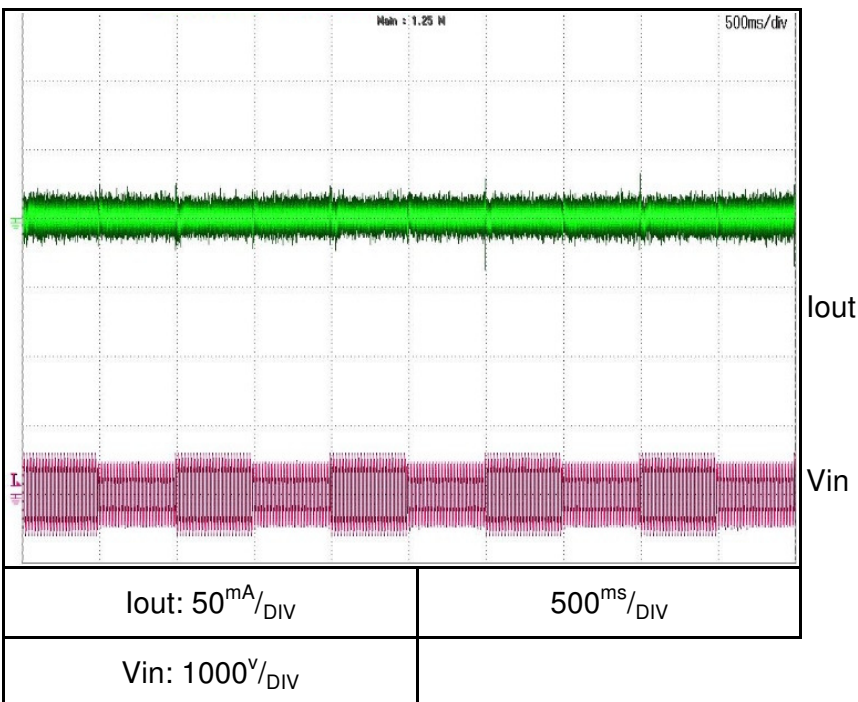

2.7 Dynamic line response characteristics

Ta = 25 °C

C.C mode

GSP600-17 3Φ480

Conditions: Vout: 100%
Iout: 100%
Vin: 342↔520V

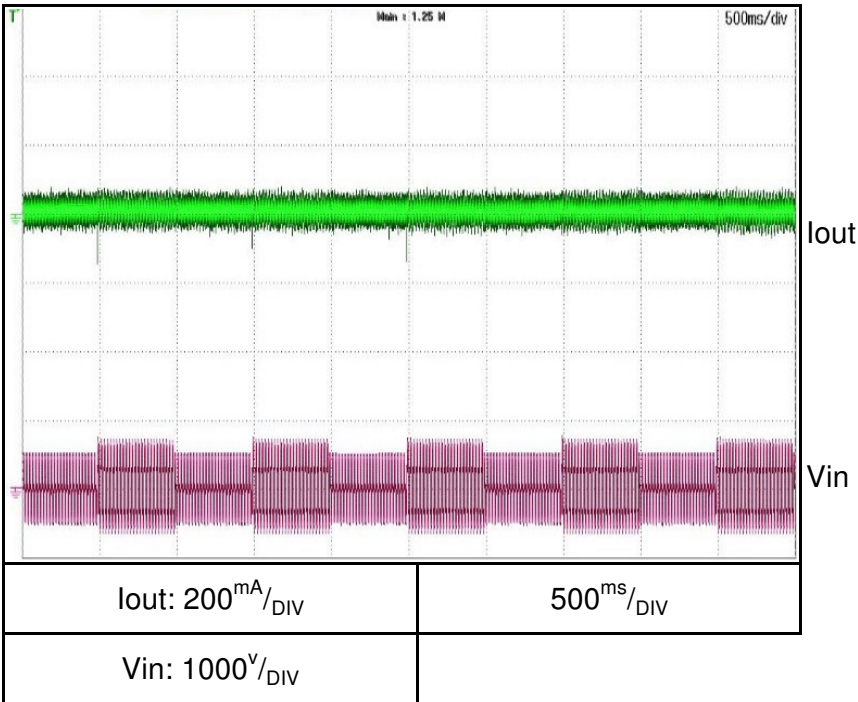

2.8 Dynamic load response characteristics
C.V mode

Conditions: Vin: Nominal
Vout: 100%
Ta = 25°C

Load current: tr=tf=100us

GSP10-1000

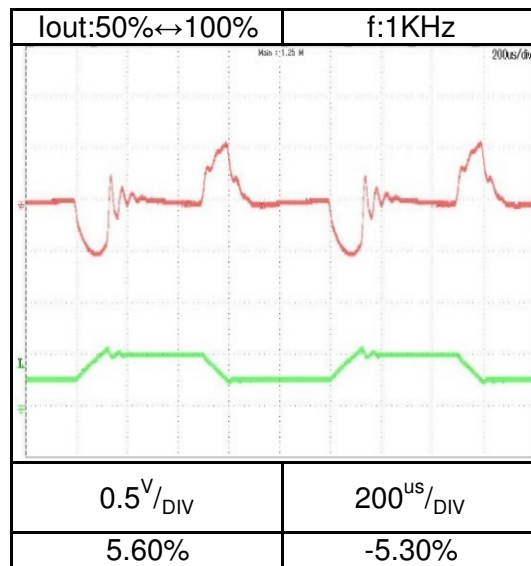
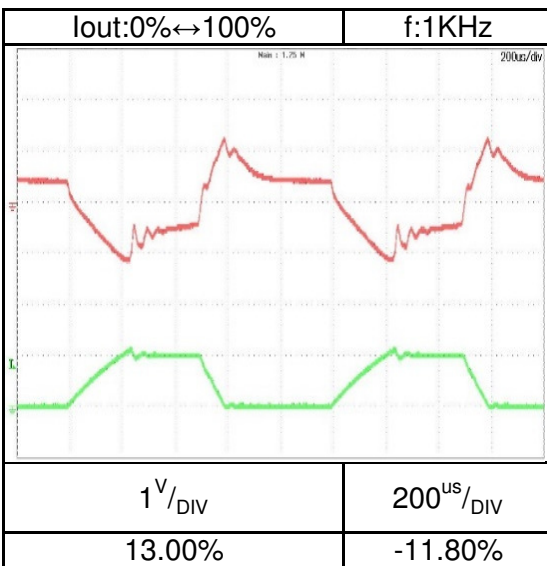
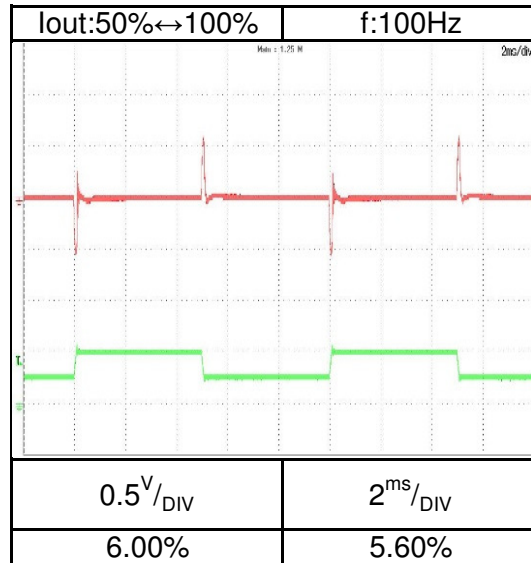
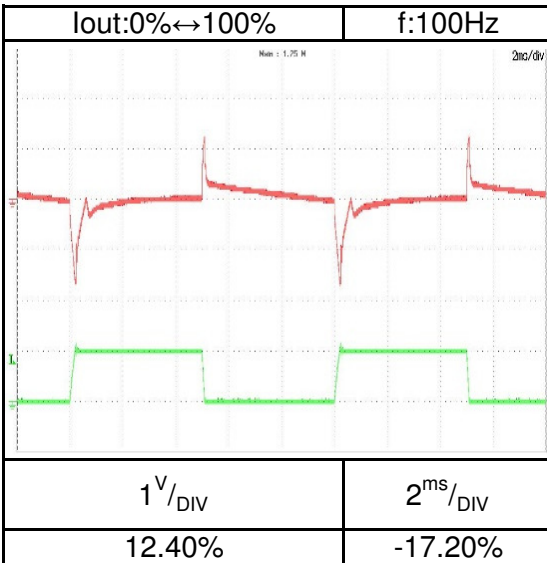

2.8 Dynamic load response characteristics
C.V mode

Conditions: Vin: Nominal
Vout: 100%
Ta = 25°C

Load current: tr=tf=100us

GSP60-170

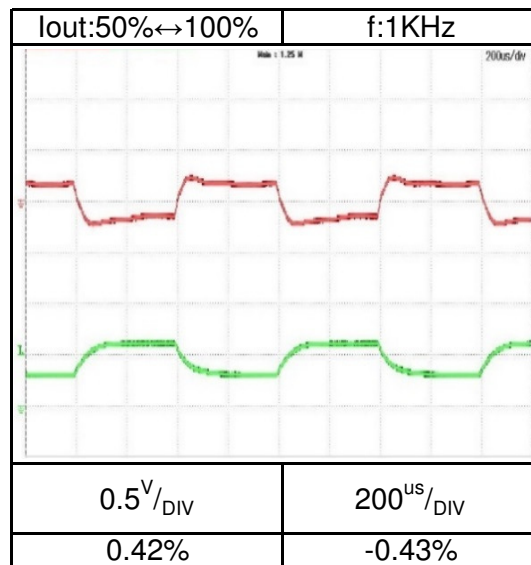
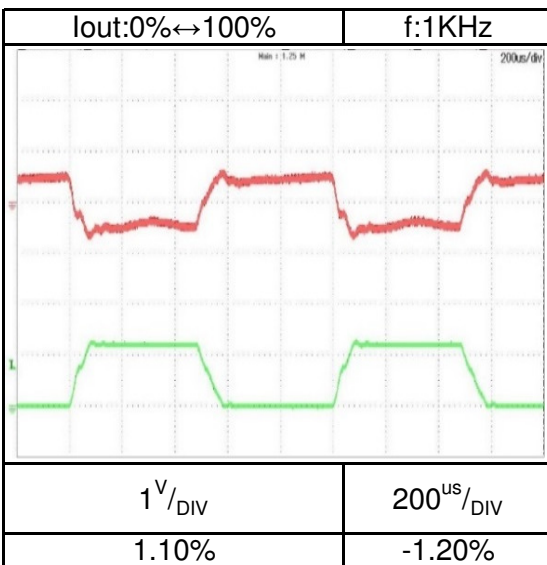
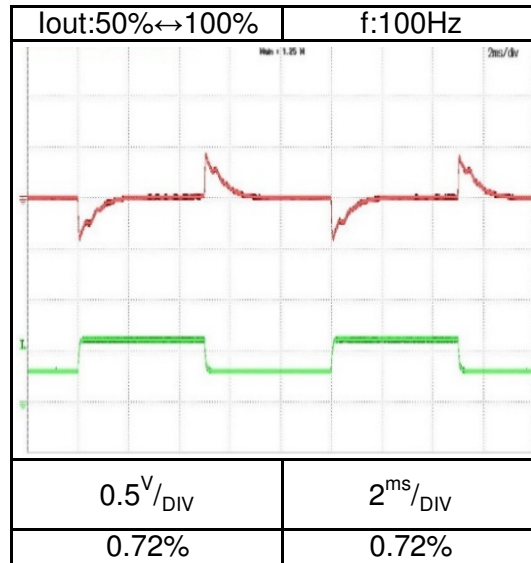
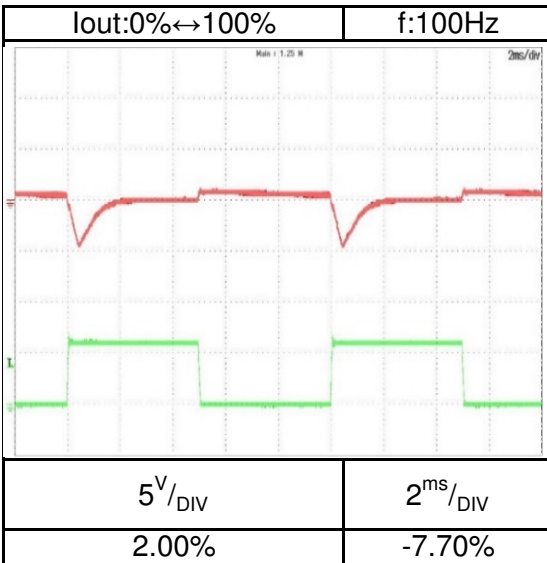

2.8 Dynamic load response characteristics
C.V mode

Conditions: Vin: Nominal
Vout: 100%
Ta = 25°C

Load current: tr=tf=100us

GSP150-68

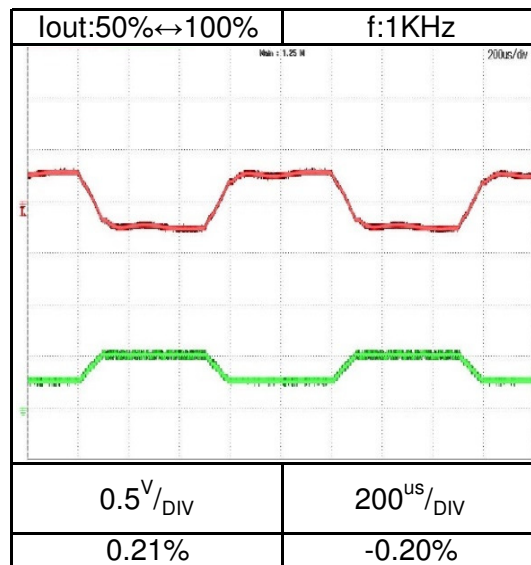
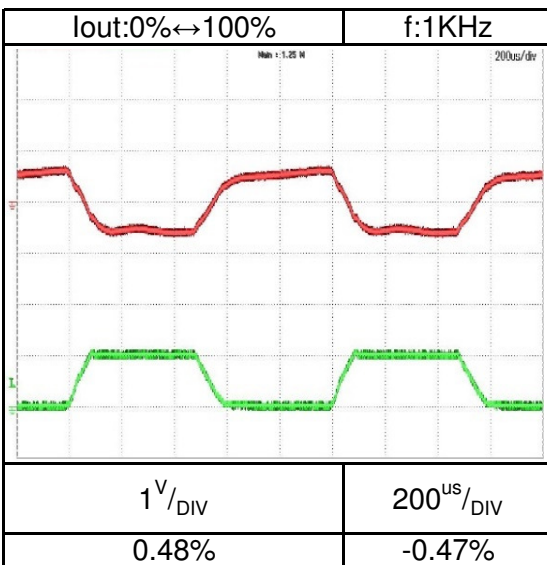
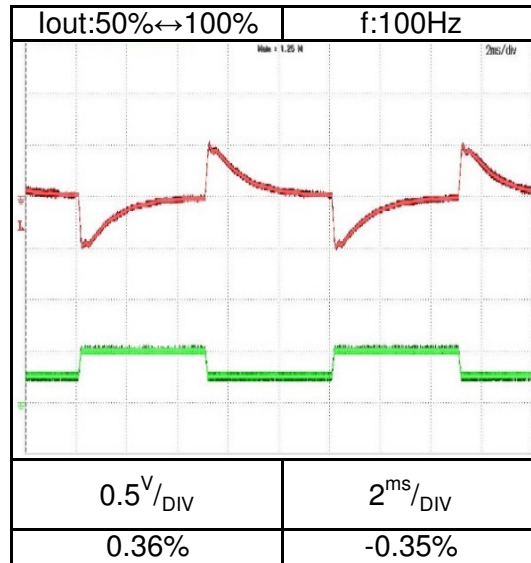
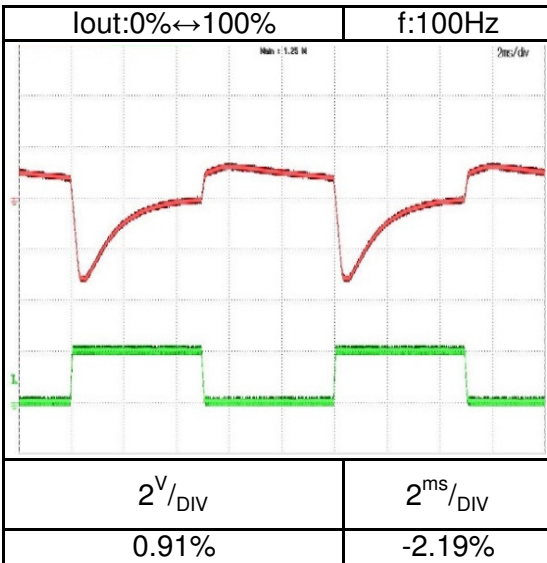

2.8 Dynamic load response characteristics
C.V mode

Conditions: Vin: Nominal
Vout: 100%
Ta = 25°C

Load current: tr=tf=100us

GSP600-17

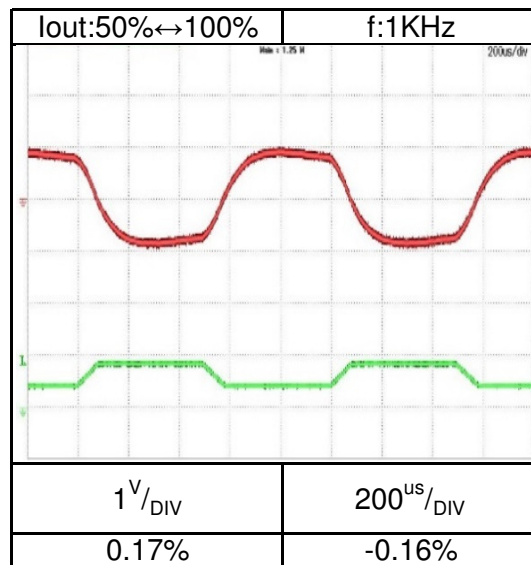
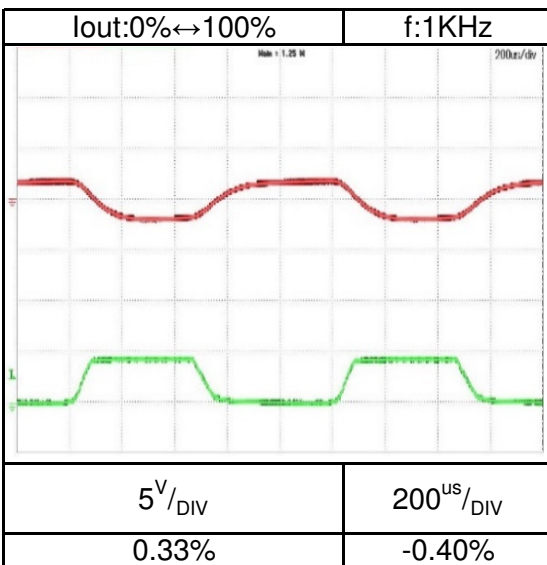
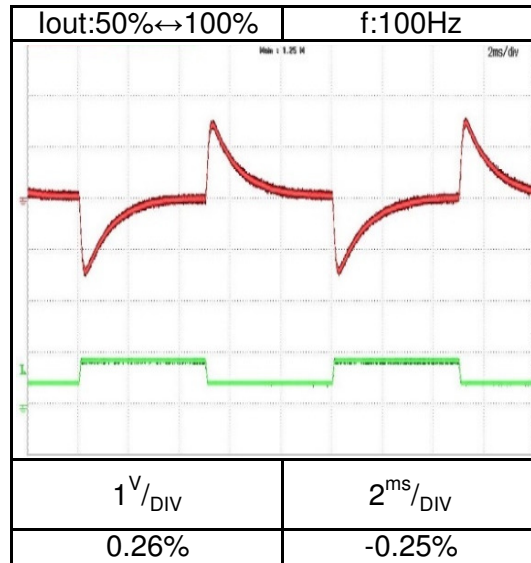
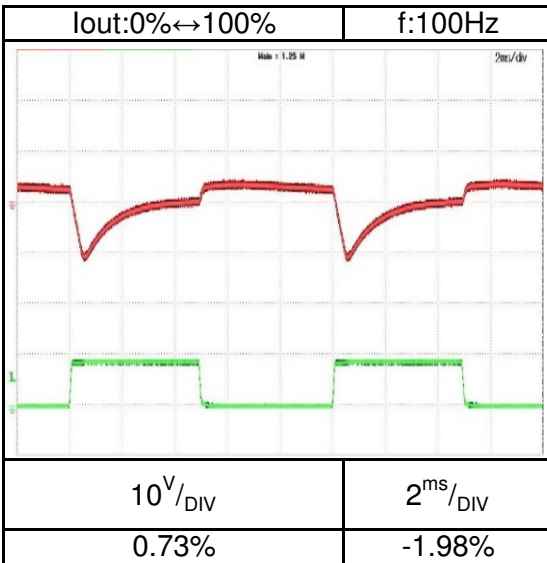

2.8 Dynamic load response characteristics
C.C mode

Conditions: Vin: Nominal
Ta = 25°C

GSP10-1000

Io=1000A

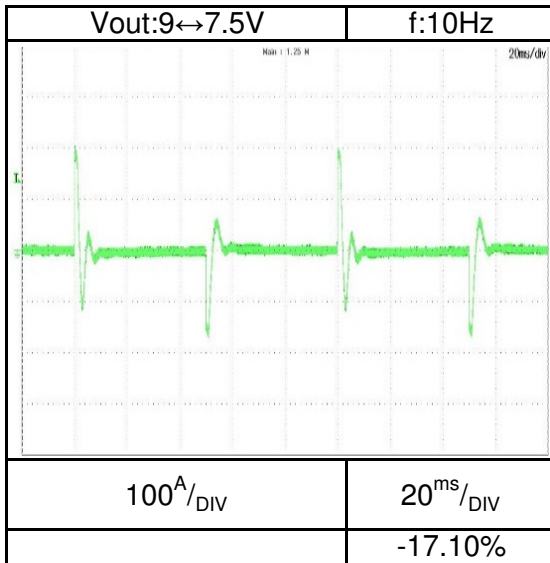

Io=500A

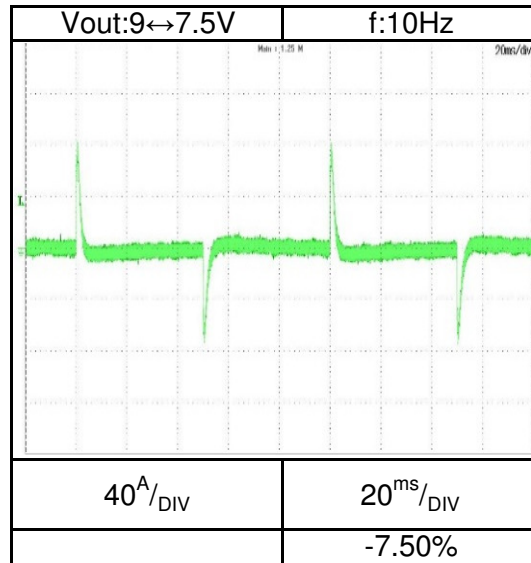

GSP60-170

Io=170A

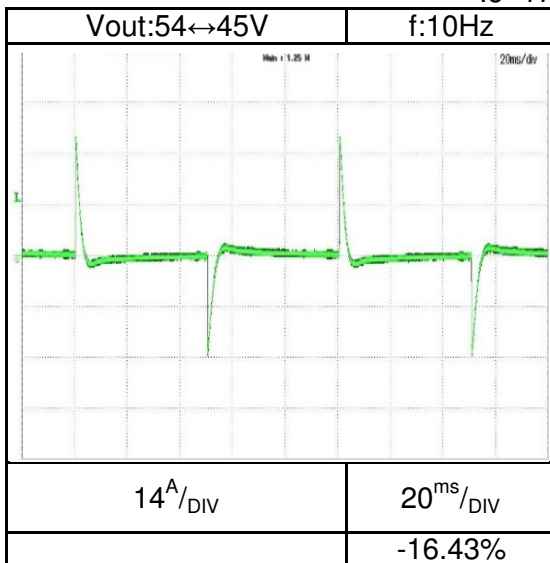

Io=85A

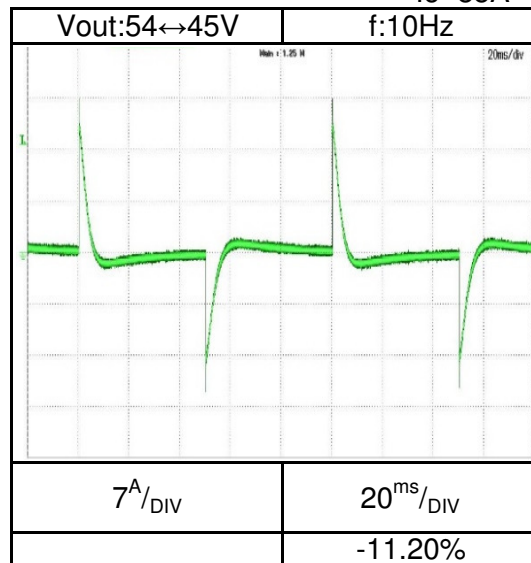

2.8 Dynamic load response characteristics
C.C mode

Conditions: Vin: Nominal
Ta = 25°C

GSP150-68

Io=68A

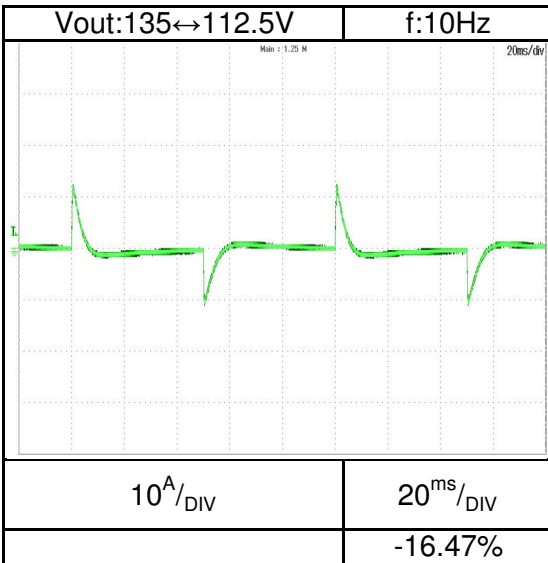

Io=34A

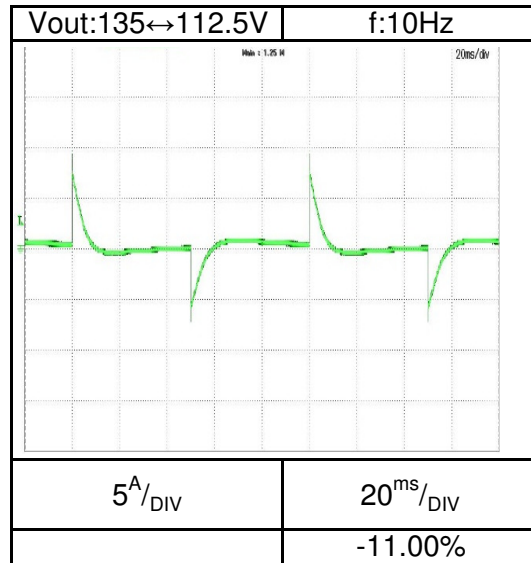

GSP600-17

Io=17A

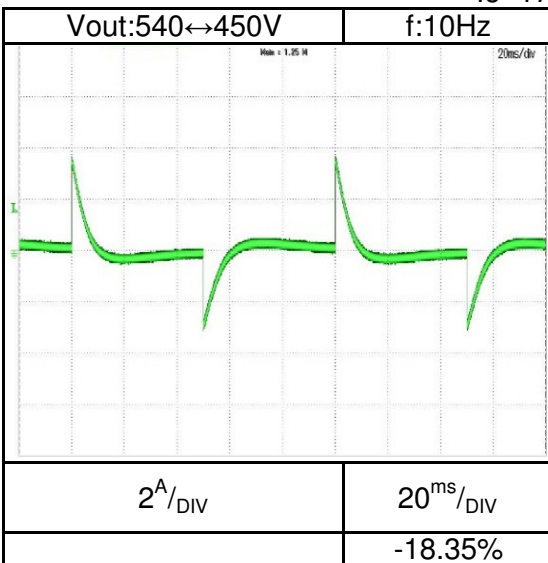

Io=8.5A

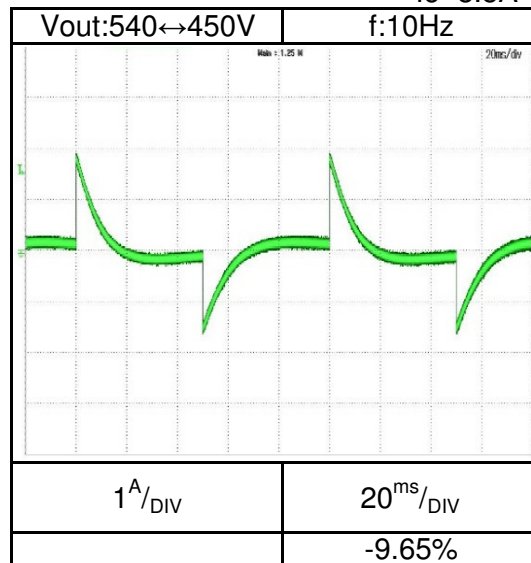

2.9 Response to brown-out characteristics
C.V mode

Conditions: Vout: 100%
Iout: 100%
Ta = 25°C

GSP10-1000 3Φ200

Vin:200VAC

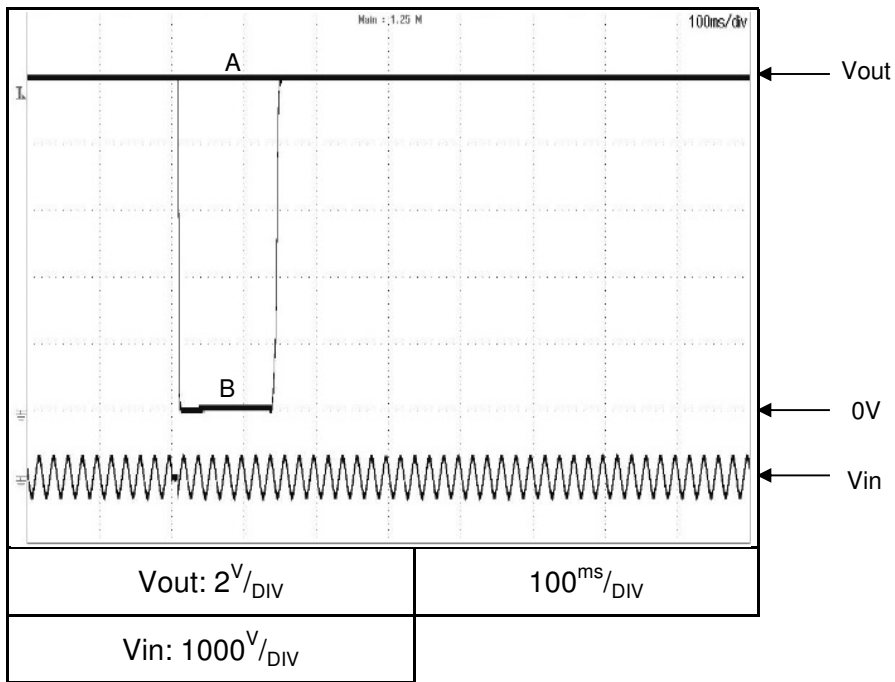

Brown-out time
A - 7ms
B - 8ms

GSP10-1000 3Φ400

Vin:400VAC

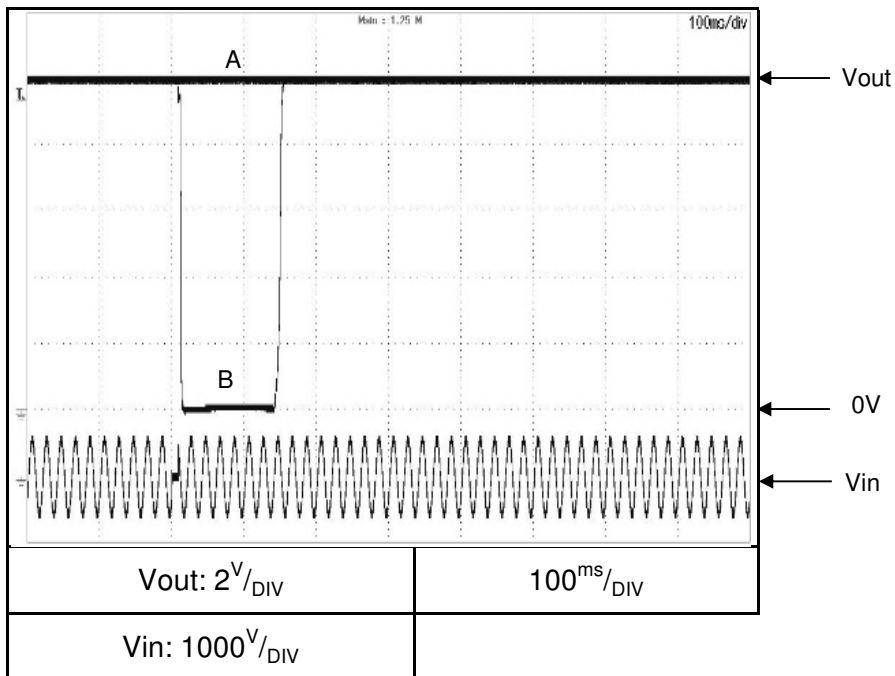

Brown-out time
A - 8ms
B - 9ms

2.9 Response to brown-out characteristics
C.V mode

Conditions: Vout: 100%
Iout: 100%
Ta = 25°C

GSP10-1000 3Φ480

Vin:480VAC

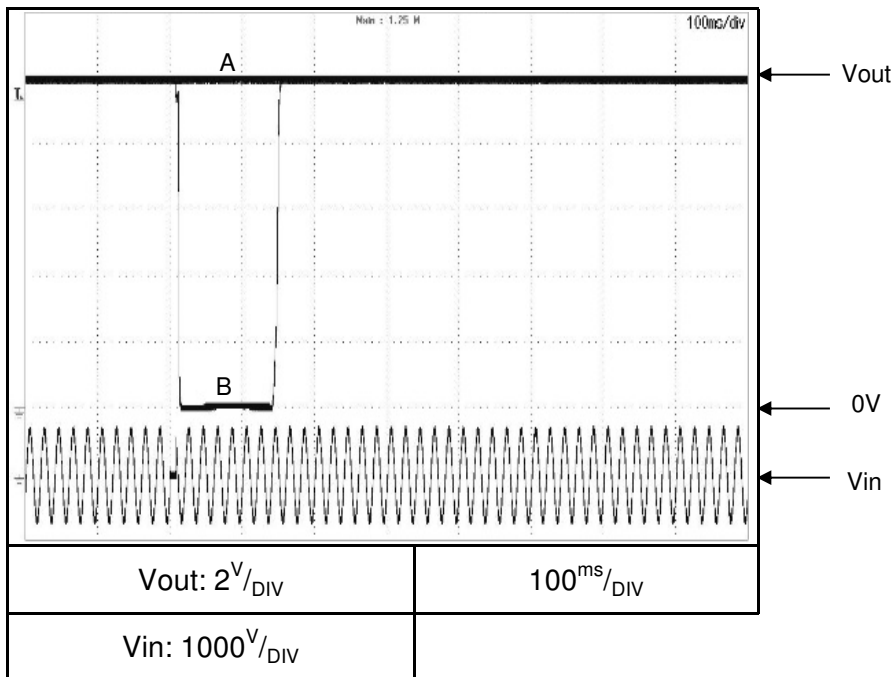

Brown-out time
A - 8ms
B - 9ms

2.9 Response to brown-out characteristics
C.C mode

Conditions: V_{out} : 100%
 I_{out} : 100%
 $T_a = 25^\circ\text{C}$

GSP10-1000 3 Φ 200

V_{in} :200VAC

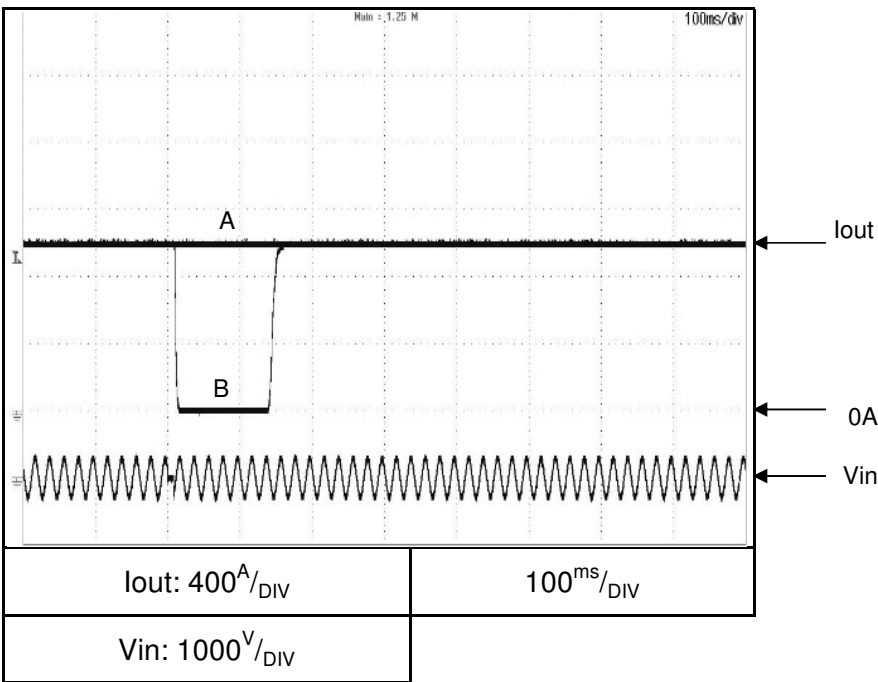

Brown-out time
A - 7ms
B - 8ms

GSP10-1000 3 Φ 400

V_{in} :400VAC

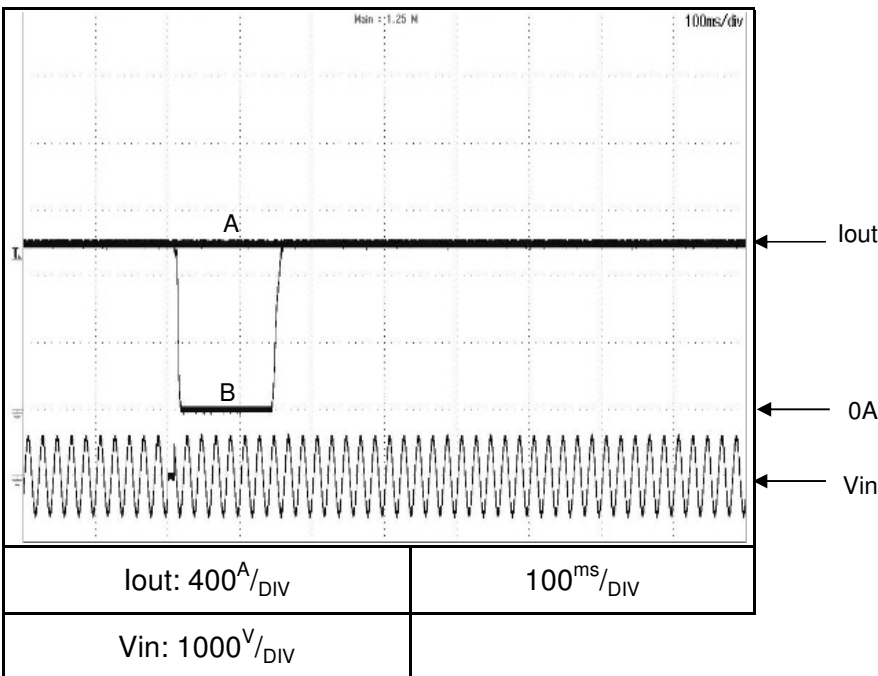

Brown-out time
A - 8ms
B - 9ms

2.9 Response to brown-out characteristics
C.C mode

Conditions: Vout: 100%
Iout: 100%
Ta = 25°C

GSP10-1000 3Φ480

Vin:480VAC

Brown-out time
A - 9ms
B - 10ms

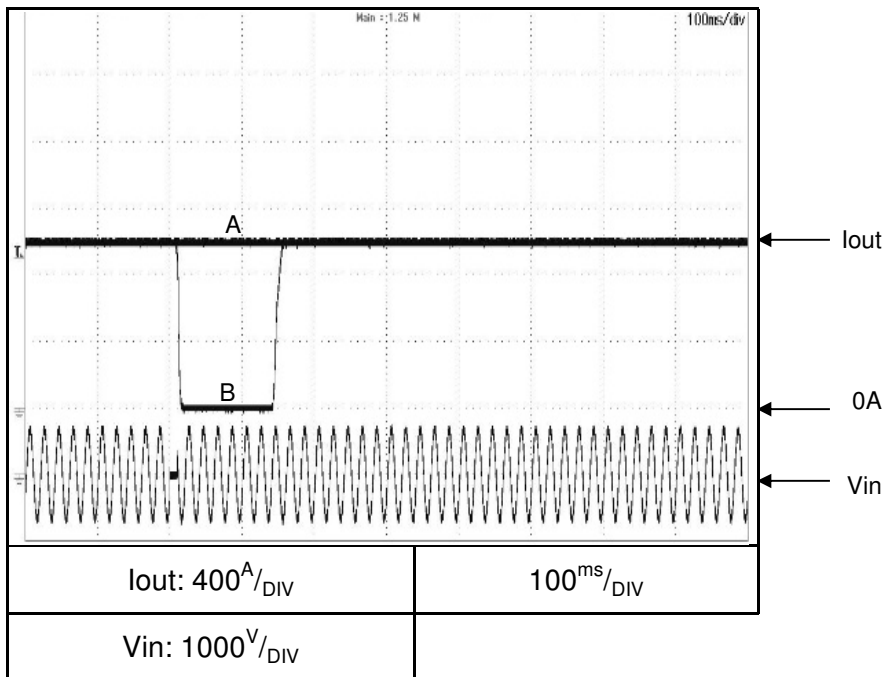

2.9 Response to brown-out characteristics
C.V mode

Conditions: Vout: 100%
Iout: 100%
Ta = 25°C

GSP60-170 3Φ400

Vin:400VAC

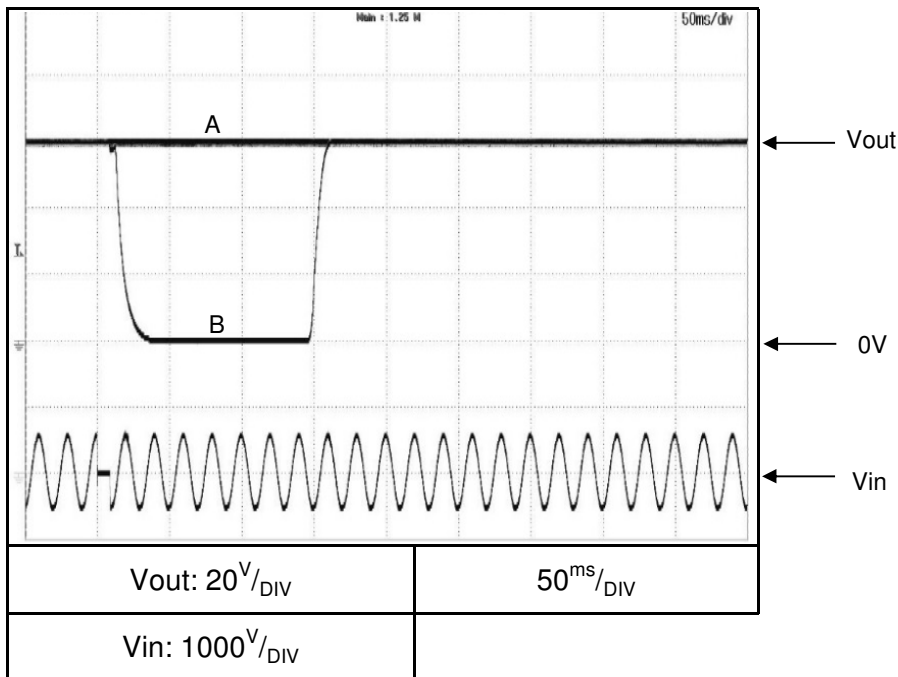

Brown-out time
A - 9ms
B - 10ms

2.9 Response to brown-out characteristics
C.C mode

Conditions: Vout: 100%
Iout: 100%
Ta = 25°C

GSP60-170 3Φ400

Vin:400VAC

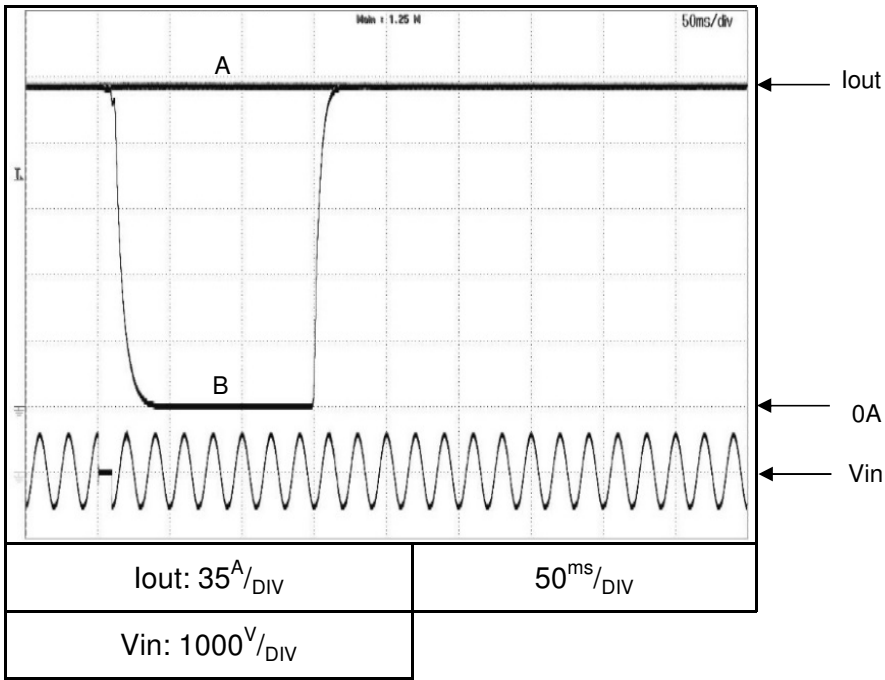

Brown-out time
A - 9ms
B - 10ms

2.9 Response to brown-out characteristics
C.V mode

Conditions: Vout: 100%
Iout: 100%
Ta = 25°C

GSP150-68 3Φ200

Vin:200VAC

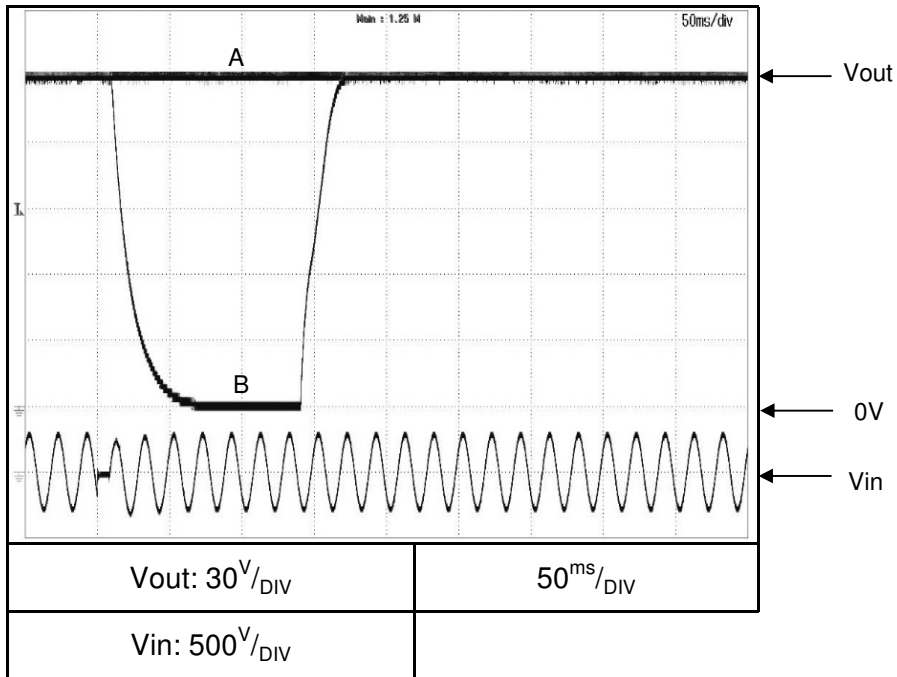

Brown-out time
A - 9ms
B - 10ms

2.9 Response to brown-out characteristics
C.C mode

Conditions: Vout: 100%
Iout: 100%
Ta = 25°C

GSP150-68 3Φ200

Vin:200VAC

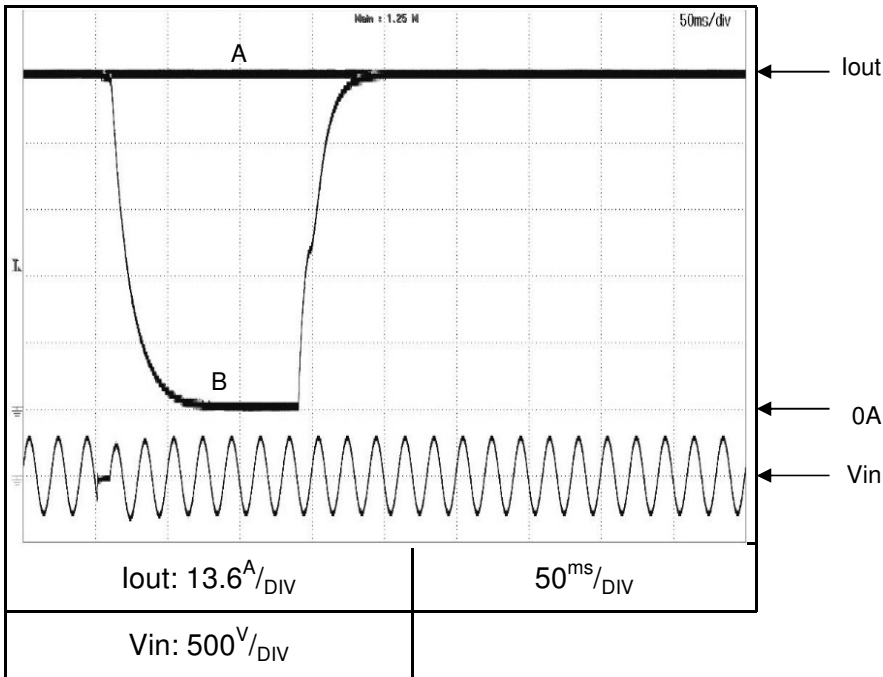

Brown-out time
A - 8ms
B - 9ms

2.9 Response to brown-out characteristics
C.V mode

Conditions: Vout: 100%
Iout: 100%
Ta = 25°C

GSP600-17 3Φ200

Vin:200VAC

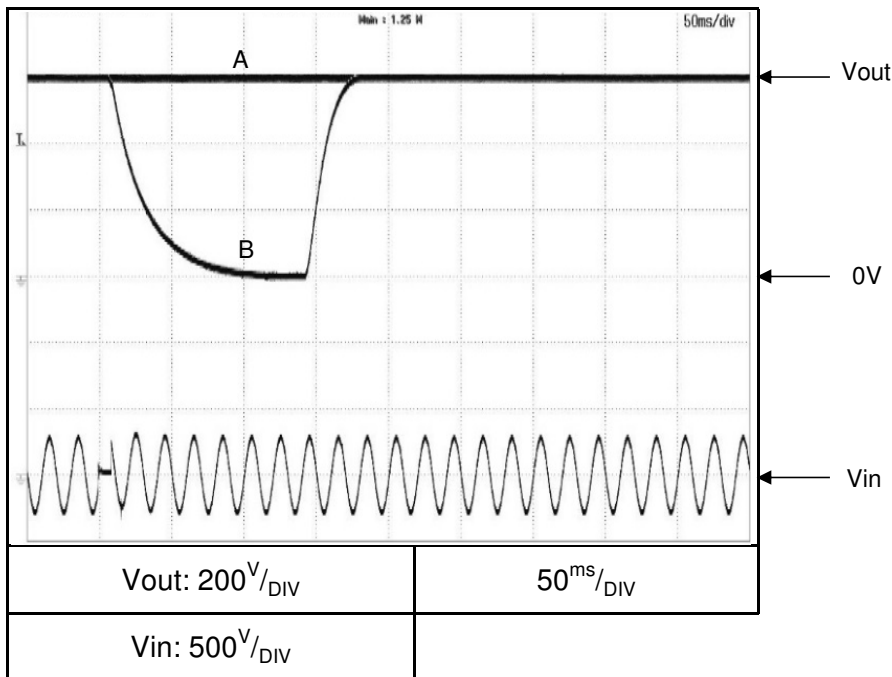

Brown-out time
A - 8ms
B - 9ms

GSP600-17 3Φ400

Vin:400VAC

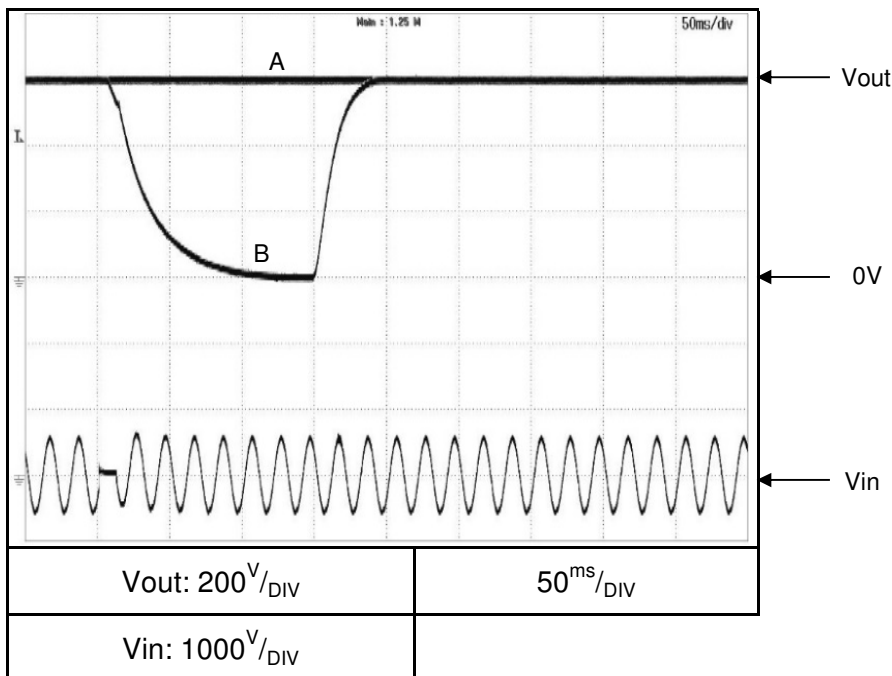

Brown-out time
A - 7ms
B - 12ms

2.9 Response to brown-out characteristics
C.V mode

Conditions: Vout: 100%
Iout: 100%
Ta = 25°C

GSP600-17 3Φ480

Vin:480VAC

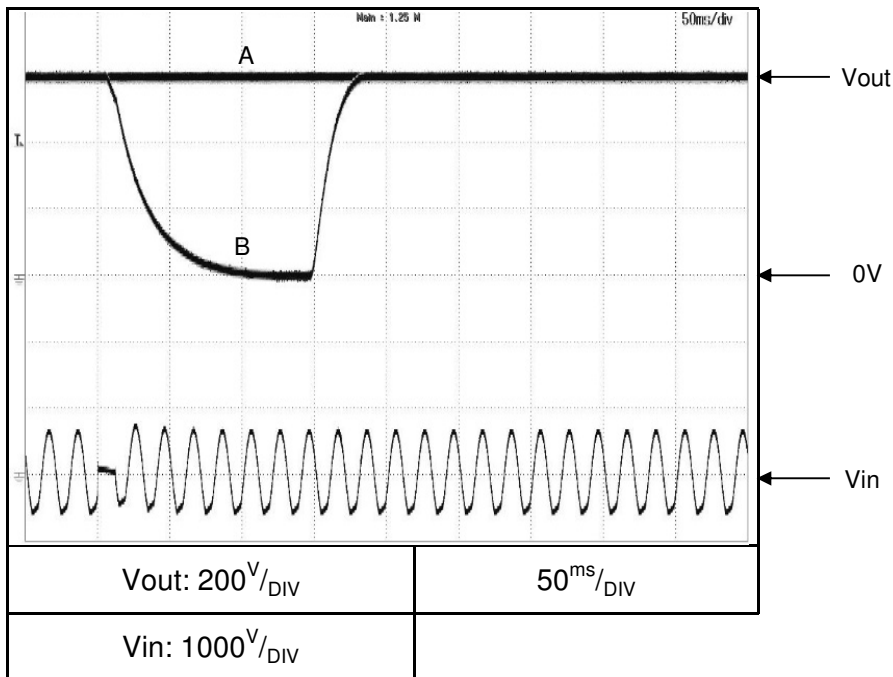

Brown-out time
A - 7ms
B - 12ms

2.9 Response to brown-out characteristics
C.C mode

Conditions: V_{out} : 100%
 I_{out} : 100%
 $T_a = 25^\circ\text{C}$

GSP600-17 3 Φ 200

V_{in} :200VAC

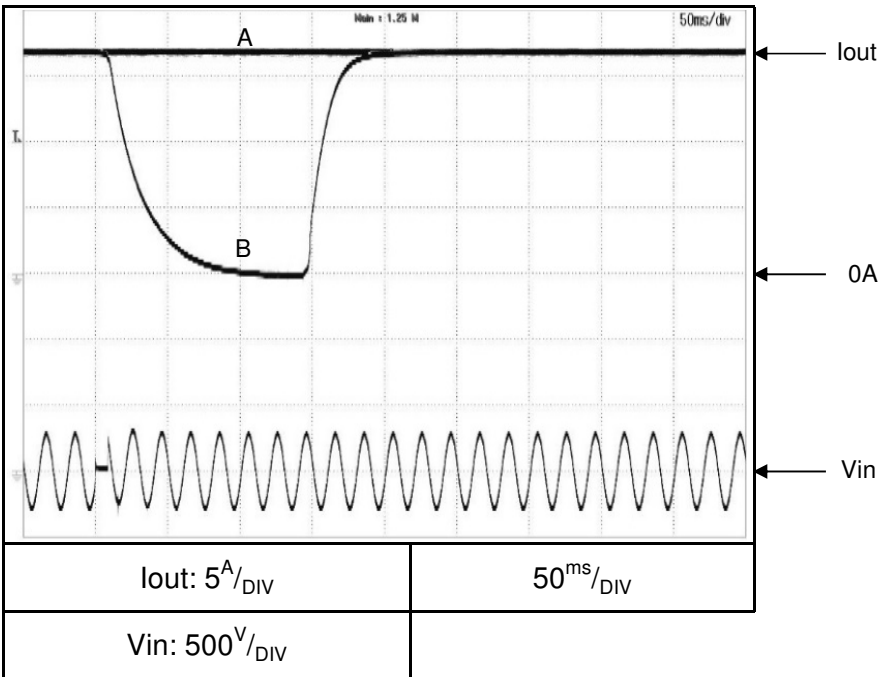

Brown-out time
A - 8ms
B - 9ms

GSP600-17 3 Φ 400

V_{in} :400VAC

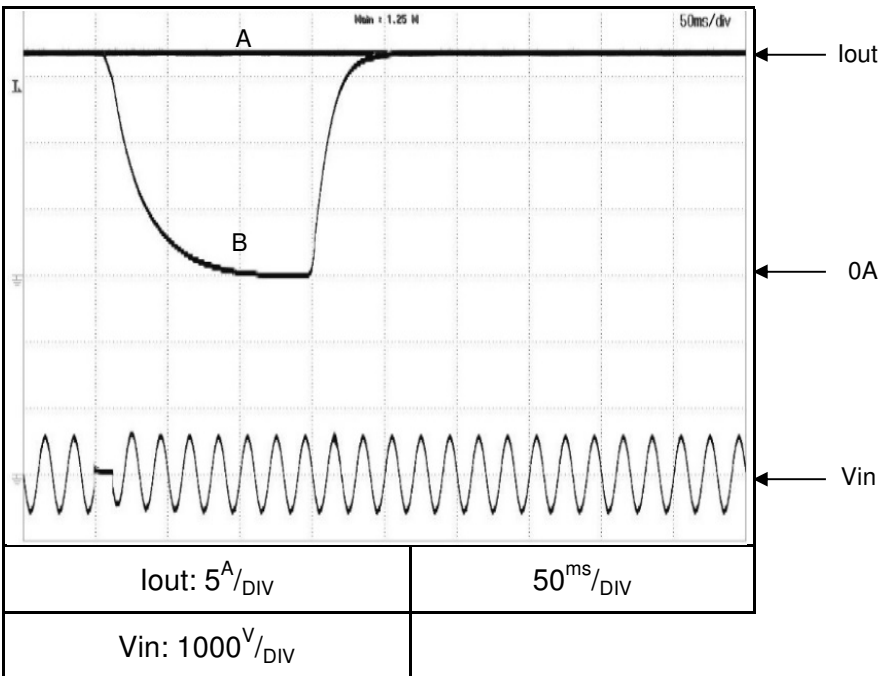

Brown-out time
A - 7ms
B - 13ms

2.9 Response to brown-out characteristics
C.C mode

Conditions: Vout: 100%
Iout: 100%
Ta = 25°C

GSP600-17 3Φ480

Vin:480VAC

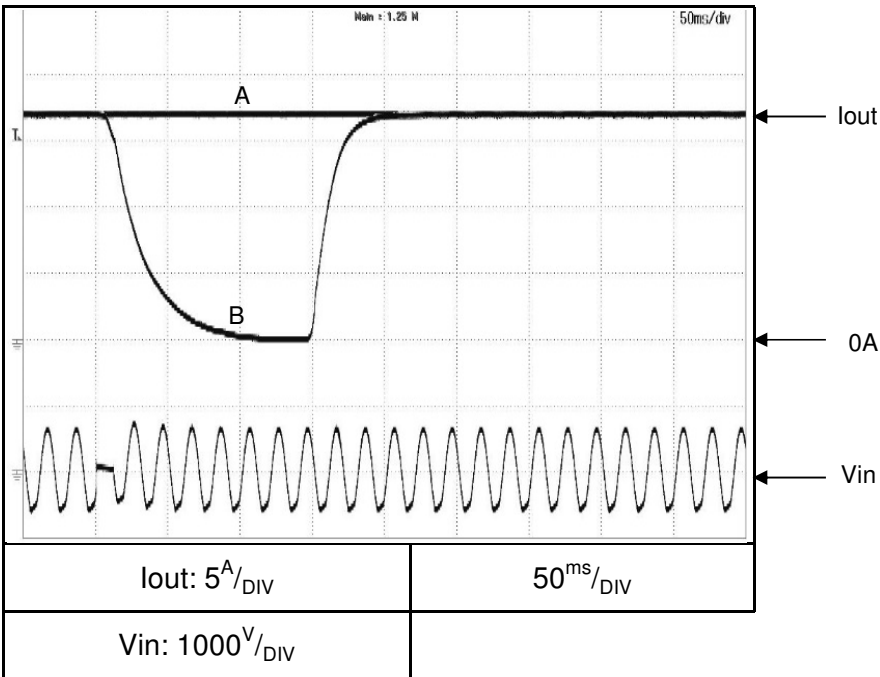

Brown-out time
A - 7ms
B - 12ms

2.10 Inrush current waveform

Conditions: Vin: 200V
Vout: 100%
Iout: 100%
Ta = 25°C

3Φ200 Input

Switch on phase angle
of input AC voltage

$\Phi=0^\circ$

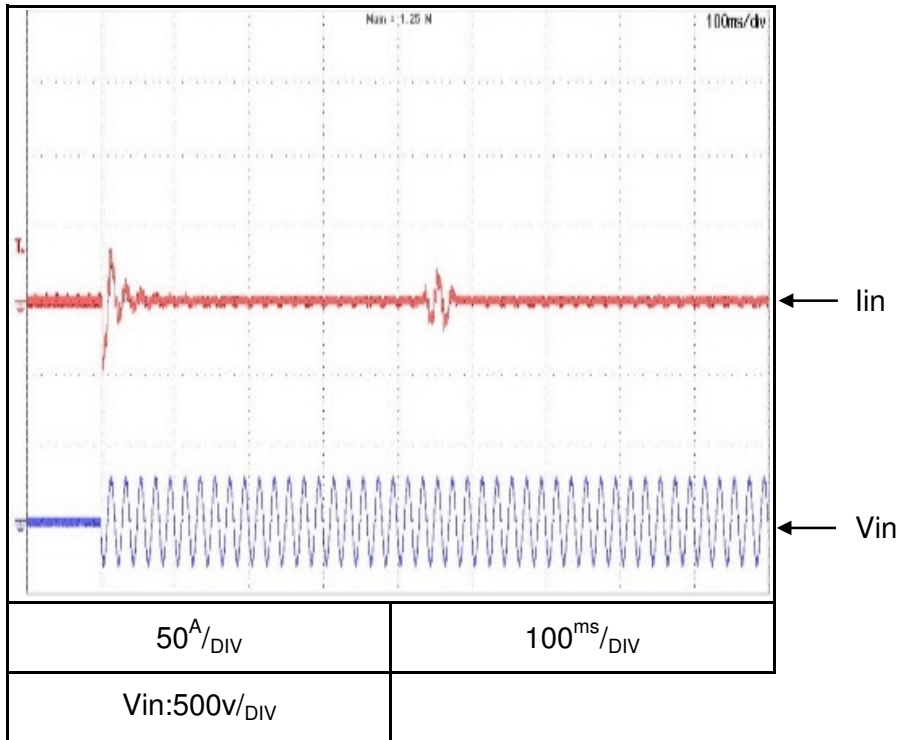

Switch on phase angle
of input AC voltage

$\Phi=90^\circ$

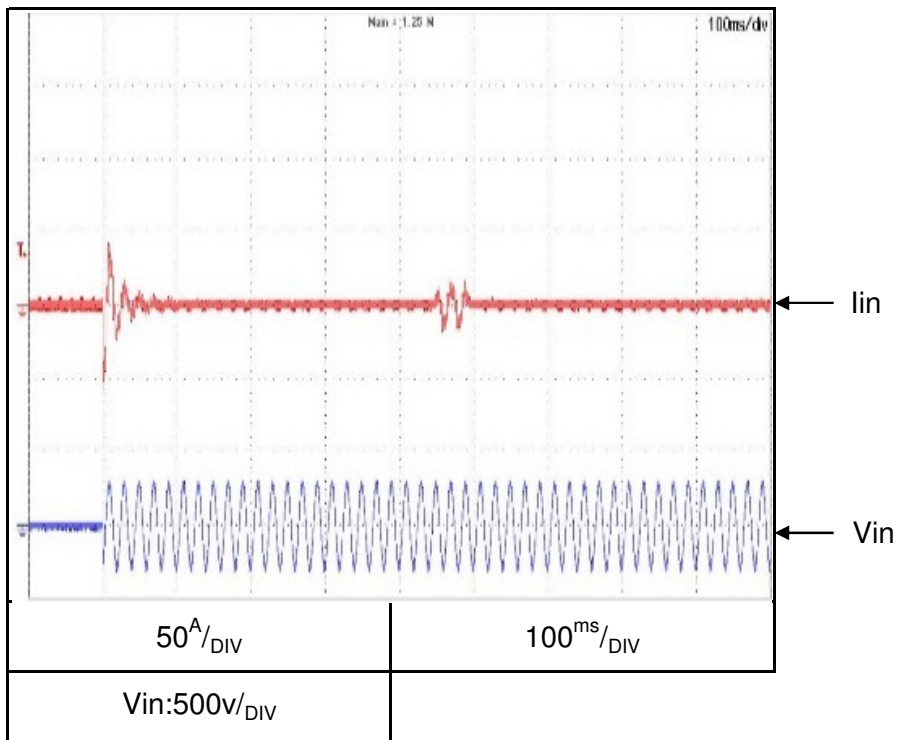

2.10 Inrush current waveform

Conditions: Vin: 480V
Vout: 100%
Iout: 100%
Ta = 25°C

3Φ400 Input

Switch on phase angle
of input AC voltage

$\Phi=0^\circ$

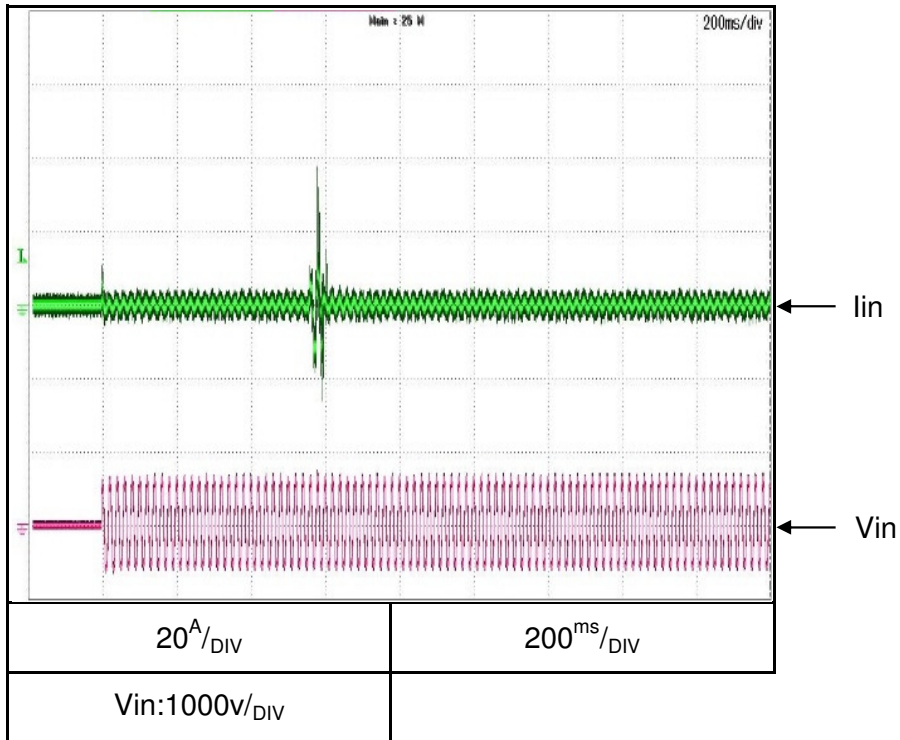

Switch on phase angle
of input AC voltage

$\Phi=90^\circ$

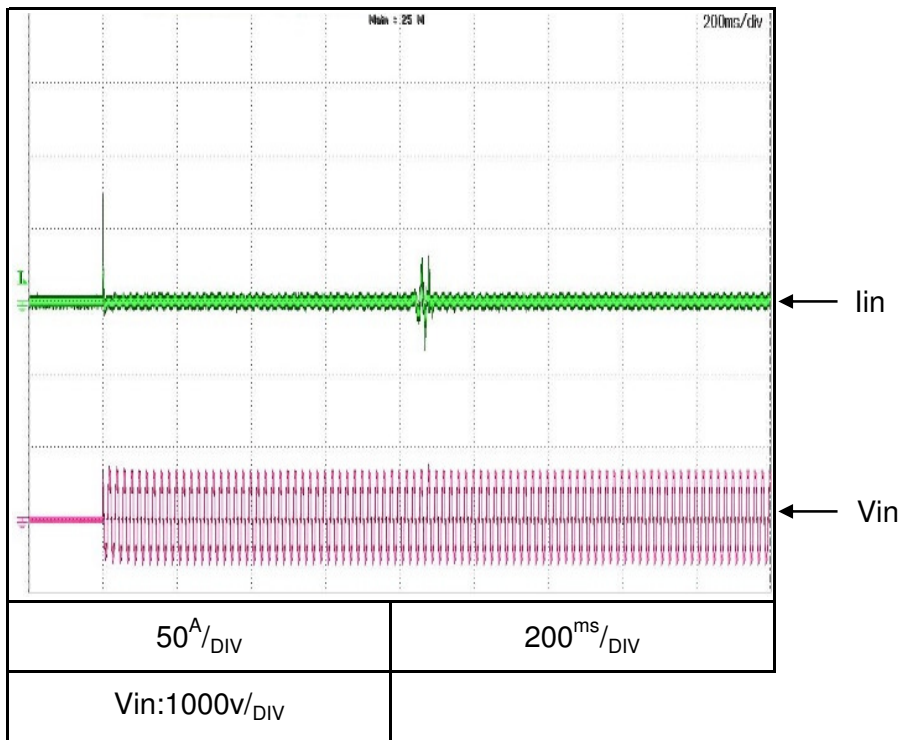

2.11 Input current waveform

Conditions: Vin: 200VAC
Vout: 100%
Iout: 100%
Ta = 25°C

3Φ200 Input

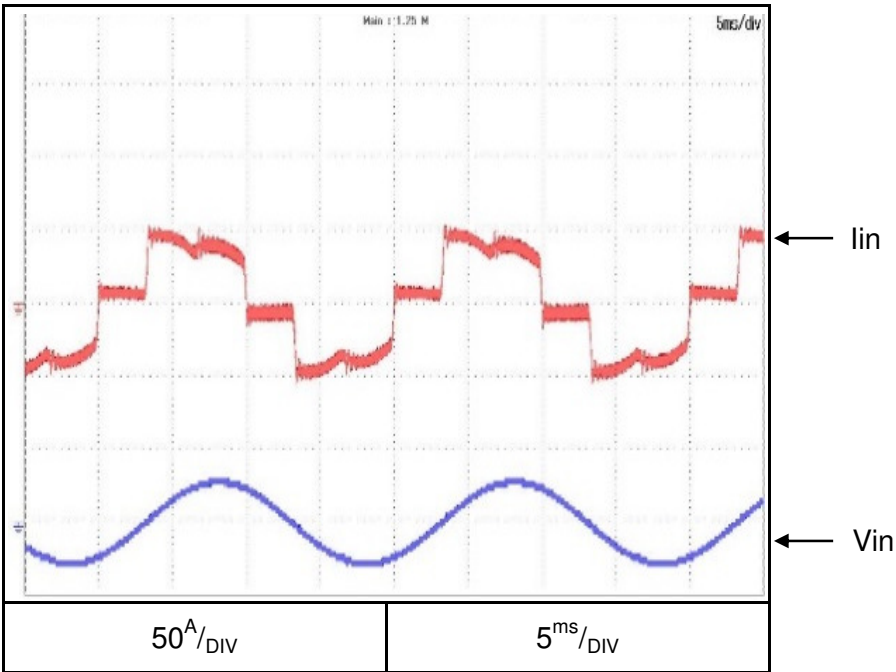

2.11 Input current waveform

Conditions: Vin: 400VAC
Vout: 100%
Iout: 100%
Ta = 25°C

3Φ400 Input

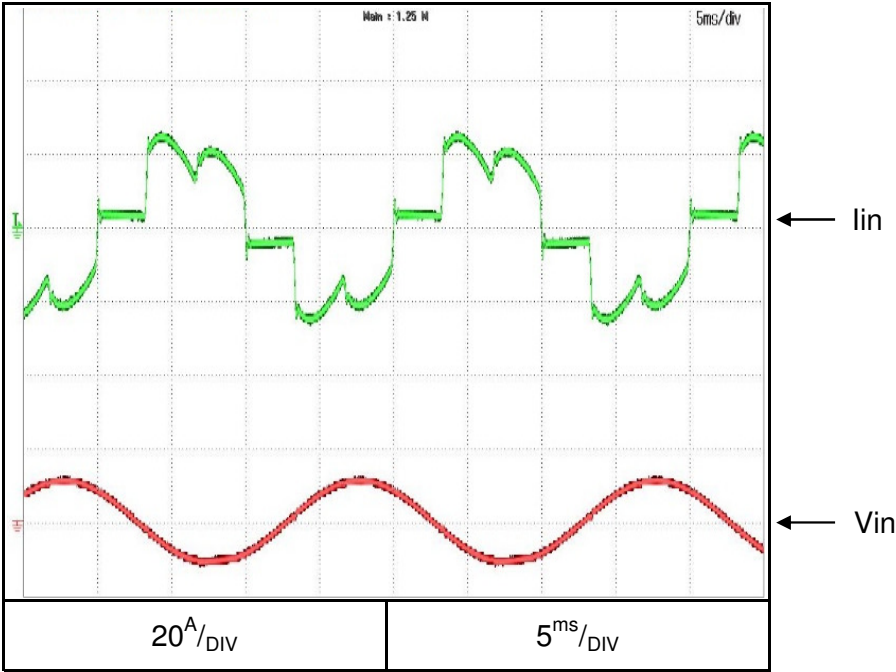

2.11 Input current waveform

Conditions: Vin: 520VAC
Vout: 100%
Iout: 100%
Ta = 25°C

3Φ480 Input

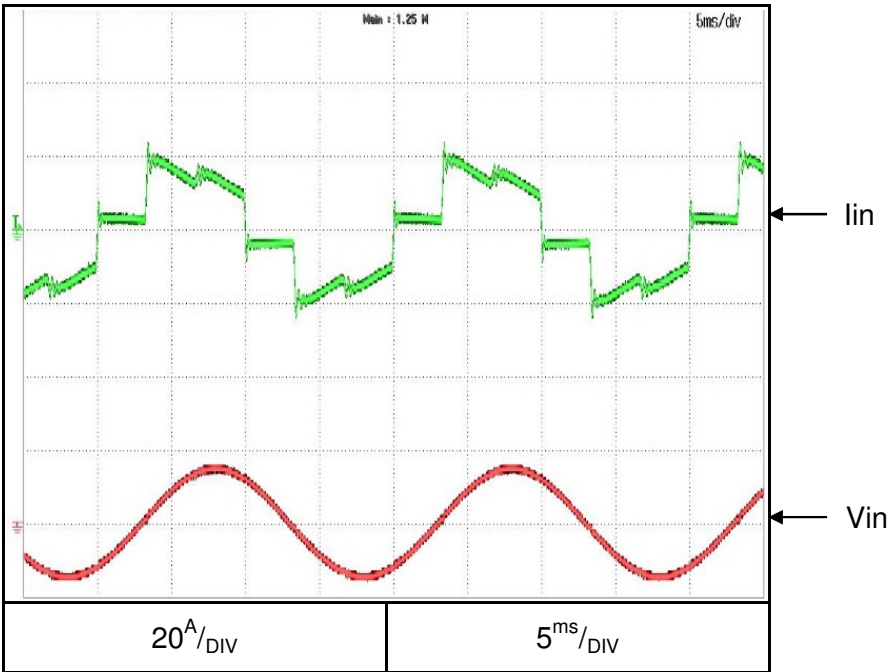

2.12 Leakage current characteristics

Conditions: Ta = 25 °C
f=60Hz

3Φ 170-265V (*)

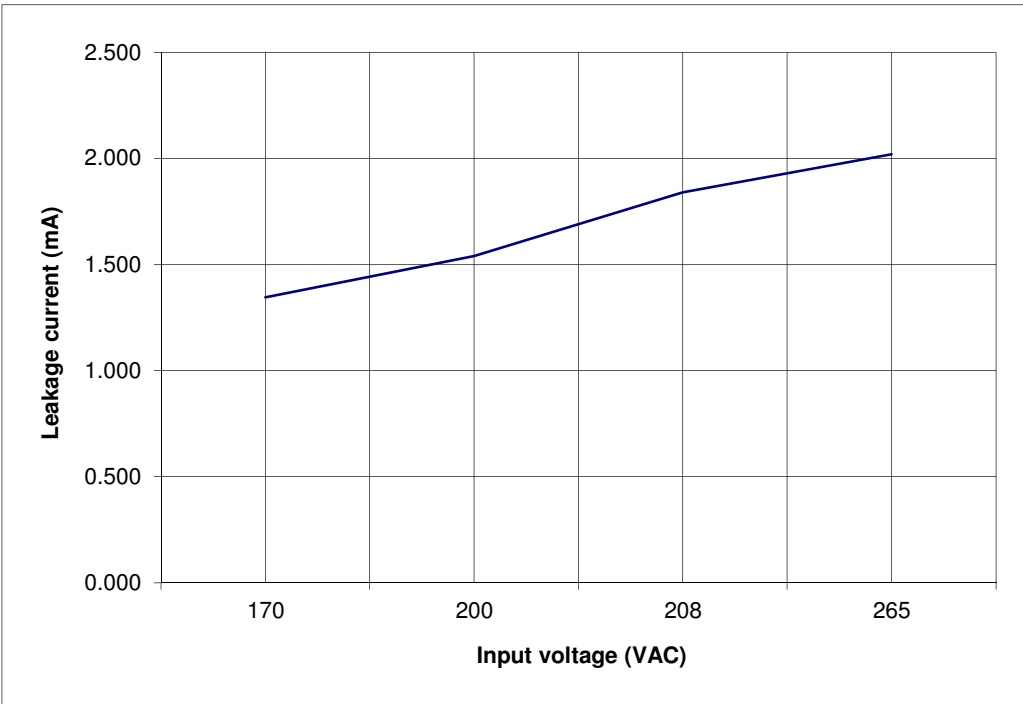

3Φ 342-520V (*)

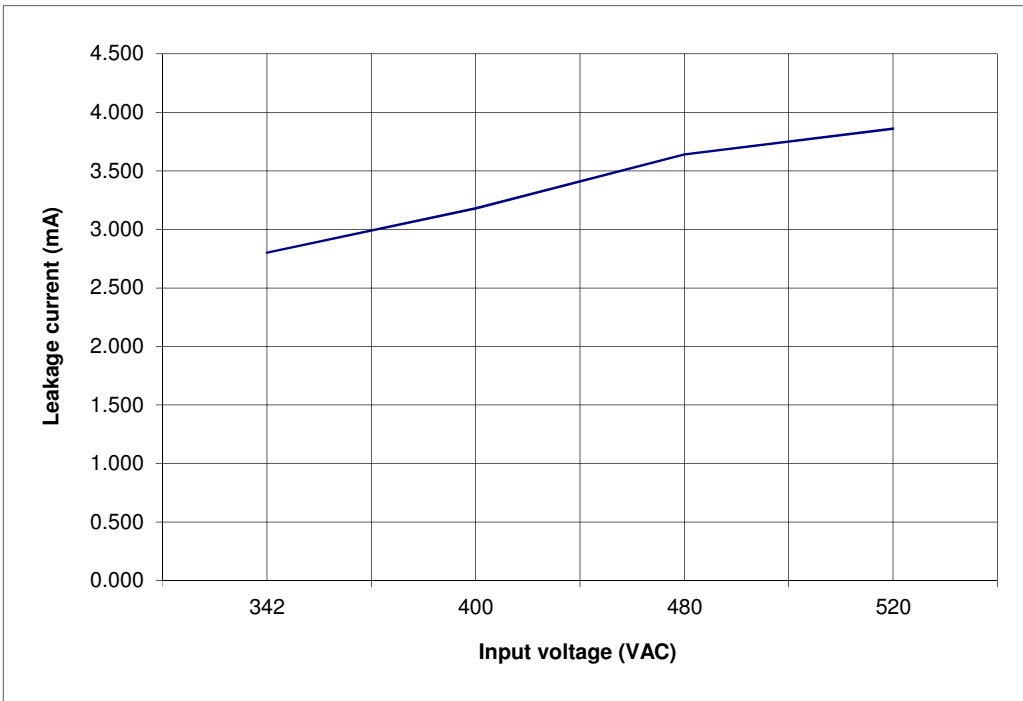

(*) TN & TT power system

2.13 Output ripple & noise waveform

C.V mode

Conditions: Vout: 100%

Iout: 100%

Ta = 25°C

Normal Mode

GSP10-1000

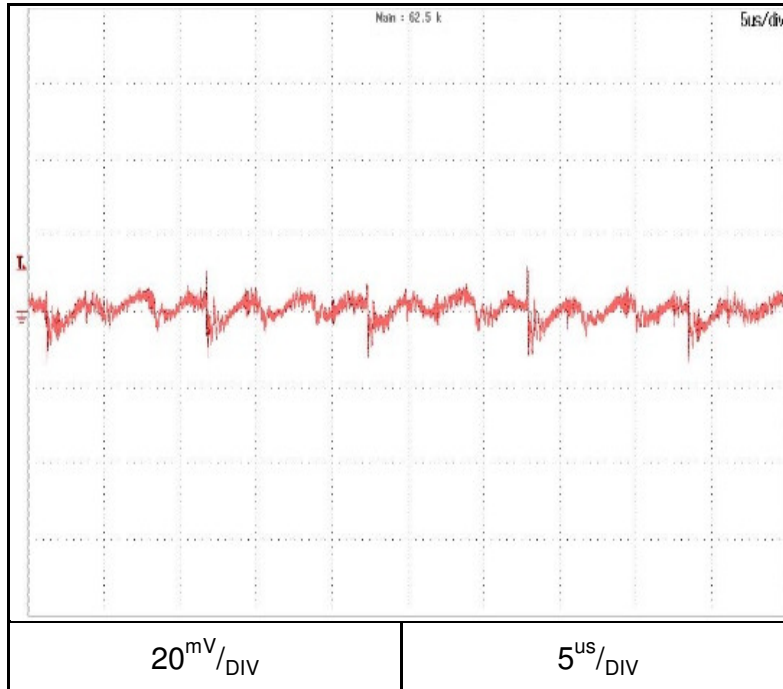

GSP60-170

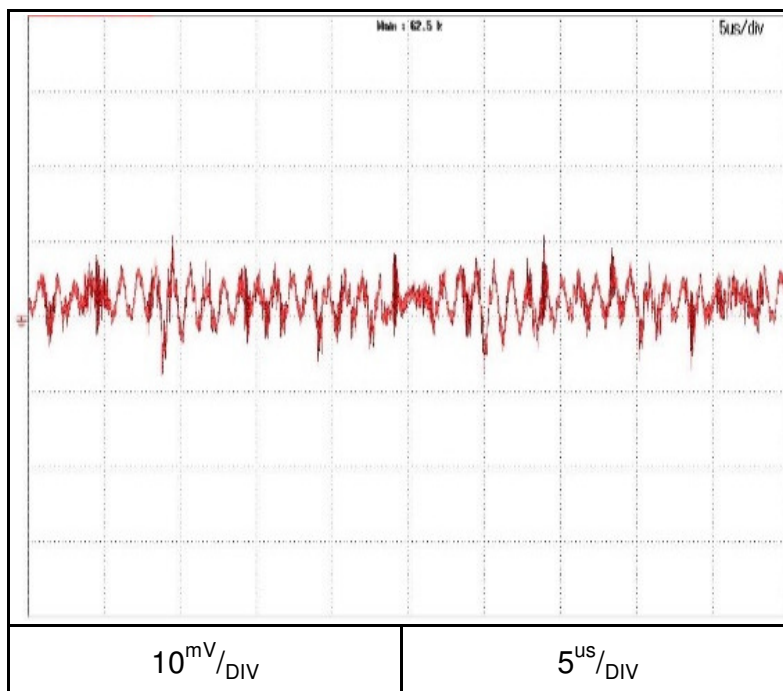

2.14 Output ripple & noise waveform

C.V mode

Conditions: Vout: 100%

Iout: 100%

Ta = 25°C

Normal Mode

GSP150-68

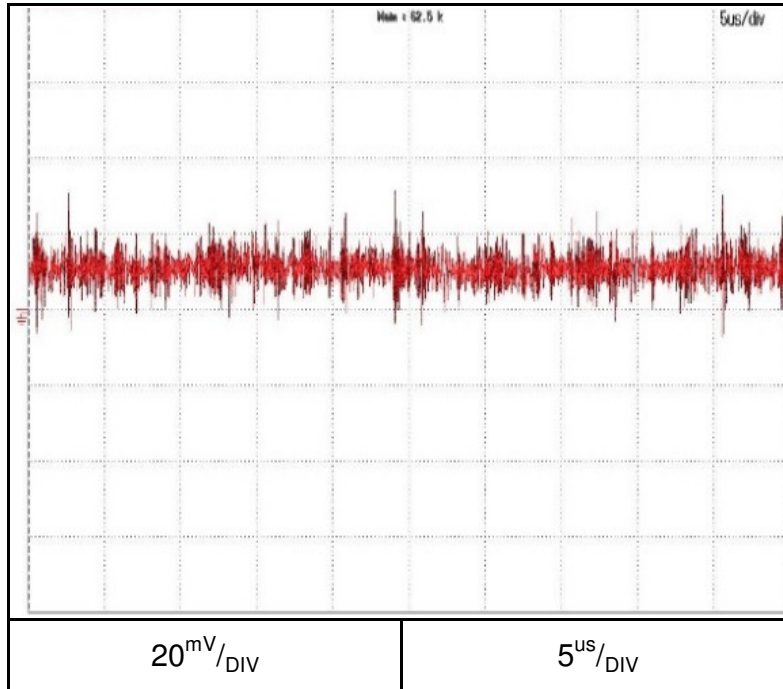

GSP600-17

