

Z⁺200 H.V Series

EVALUATION

DATA

DWG No.: IA779-53-02		
APPD	CHK	DWG
<i>J</i> 22/6/14	Karmi S. June-19-14	Bar B. 19/6/14

INDEX

PAGE

1. EVALUATION METHOD	
1.1 Circuit used for determination	T-1~4
(1) Steady state data	
(2) Warm up voltage drift characteristics	
(3) Warm up current drift characteristics	
(4) Over voltage protection (OVP) characteristics	
(5) Output voltage rise/fall characteristics	
(6) Output current rise/fall characteristics	
(7) Dynamic line voltage and current response characteristics	
(8) Dynamic load voltage and current response characteristics	
(9) Response to brown-out characteristics	
(10) Inrush current characteristics	
(11) Leakage current characteristics	
(12) Output Voltage ripple & noise waveform 160V to 650V models	
(13) Output Current ripple & noise waveform 160V to 650V models	
1.2 List of equipment used	T-5
2. CHARACTERISTICS	
2.1 Steady state data	
(1) Regulation - Line & Load, Temperature drift	T-06~09
(2) Output voltage and ripple voltage v.s input voltage	T-10~11
(3) Output current and ripple current v.s input voltage	
(4) Efficiency and Input current vs. Output current	T-12~13
2.2 Warm up voltage drift & temperature stability	T-14~15
2.3 Over voltage protection (OVP) characteristics	T-16
2.4 ON/OFF Output rise characteristics	T-17~20
2.5 ON/OFF Output fall characteristics	T-21~24
2.6 Hold up time characteristics	T-25~26
2.7 Dynamic line response characteristics	T-27~30
2.8 Dynamic load response characteristics	T-31~33
2.9 Response to brown-out characteristics	T-34~37
2.10 Inrush current characteristics	T-38~39
2.11 Inrush current waveform	T-40~43
2.12 Input current waveform	T-44~45
2.13 Leakage current characteristics	T-46
2.14 Output voltage ripple & noise waveform	T-47

TERMINOLOGY USED

Definition

V_{in}	Input voltage
V_{out}	Output voltage
I_{in}	Input current
I_{out}	Output current
T_a	Ambient temperature
f	Frequency
C.V	Constant voltage mode
C.C	Constant current mode

1. EVALUATION METHOD

1.1 Circuit used for determination

(1) Steady state data

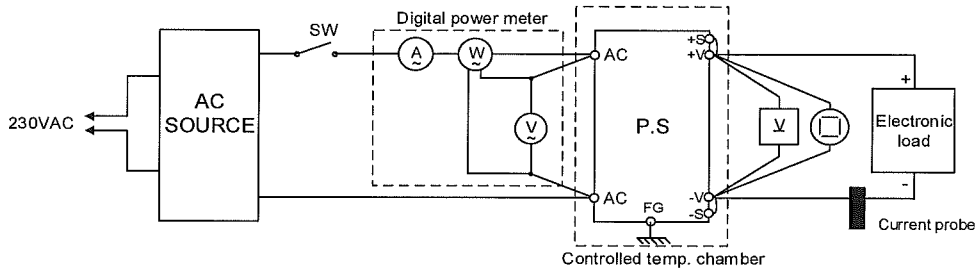

(2) Warm up voltage drift characteristics same as Steady state data

(3) Warm up current drift characteristics same as Steady state data

(4) Over voltage protection (OVP) characteristics

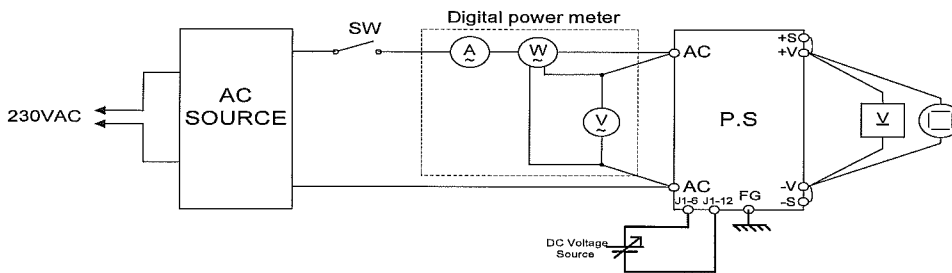

(5) Output voltage rise/fall characteristics same as Steady state data

(6) Output current rise/fall characteristics

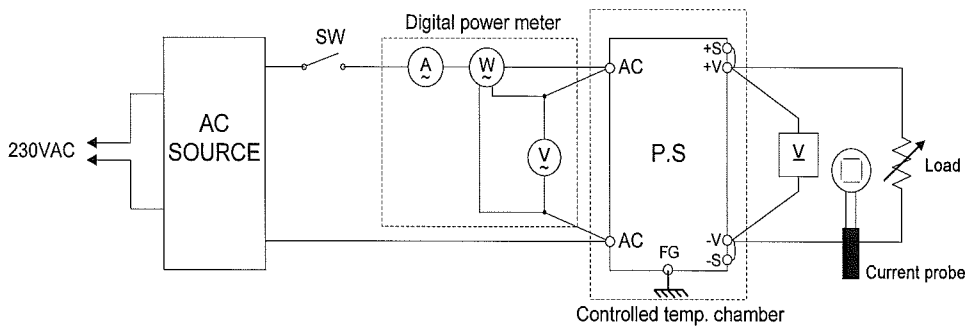

1.1 Circuit used for determination

(7) Dynamic line voltage and current response characteristics

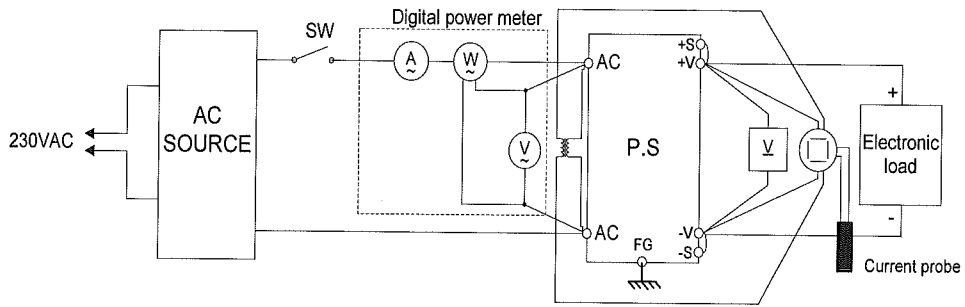

(8) Dynamic load voltage and current response characteristics

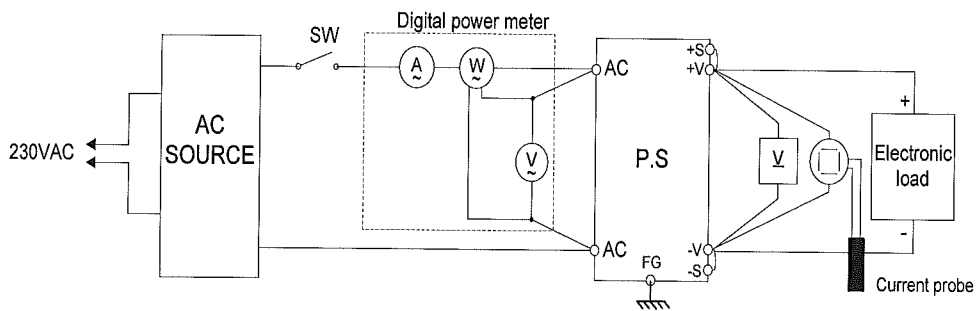

Constant Voltage mode

Output current waveform

I_{out} 0% <---> 100%

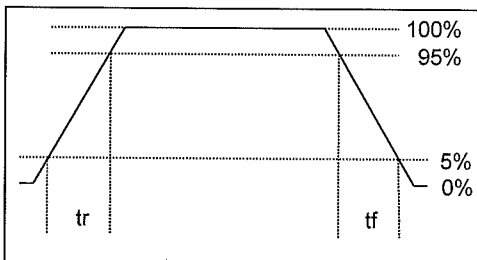

Output current waveform

I_{out} 50% <---> 100%

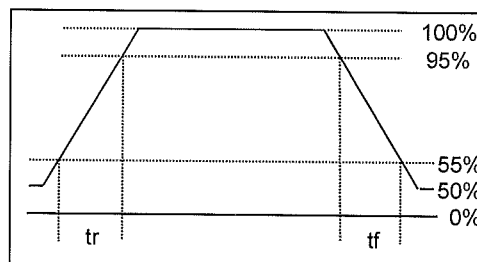

1.1 Circuit used for determination

(9) Response to brown-out characteristics

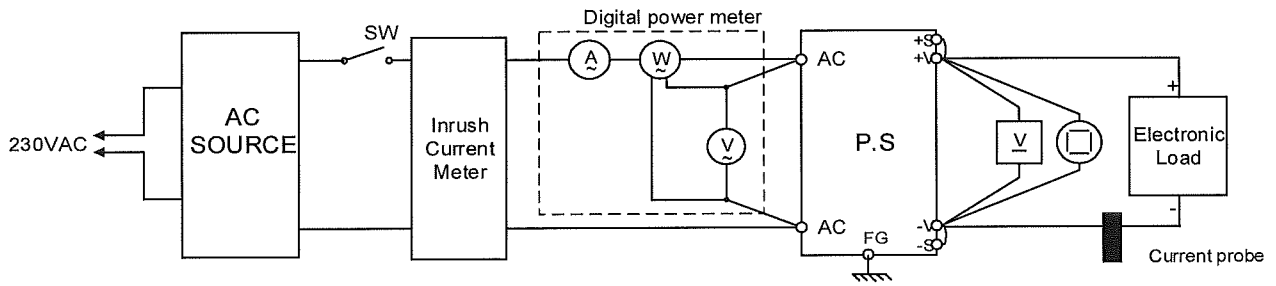

(10) Inrush current characteristics same as Response to brown-out

(11) Leakage current characteristics

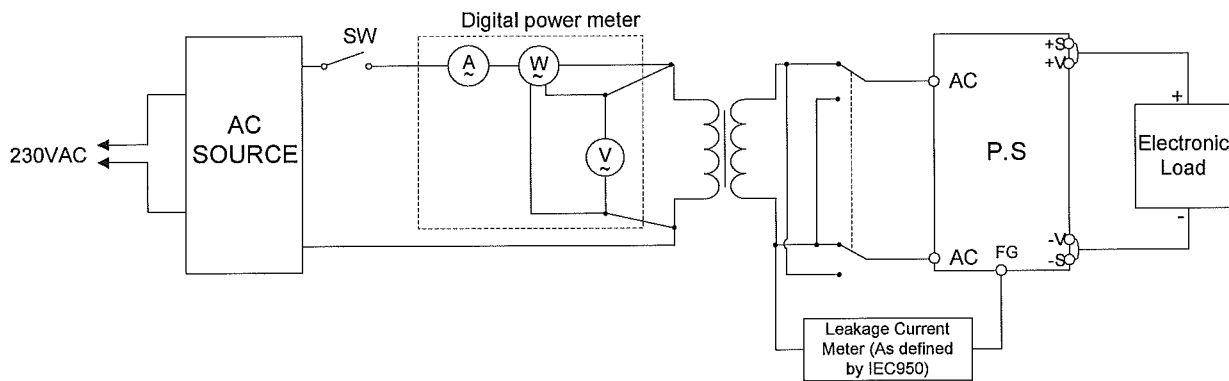

(12) Output Voltage ripple & noise waveform 160V up to 650V models

(a) Normal mode (JEITA Standard RC-9131A)

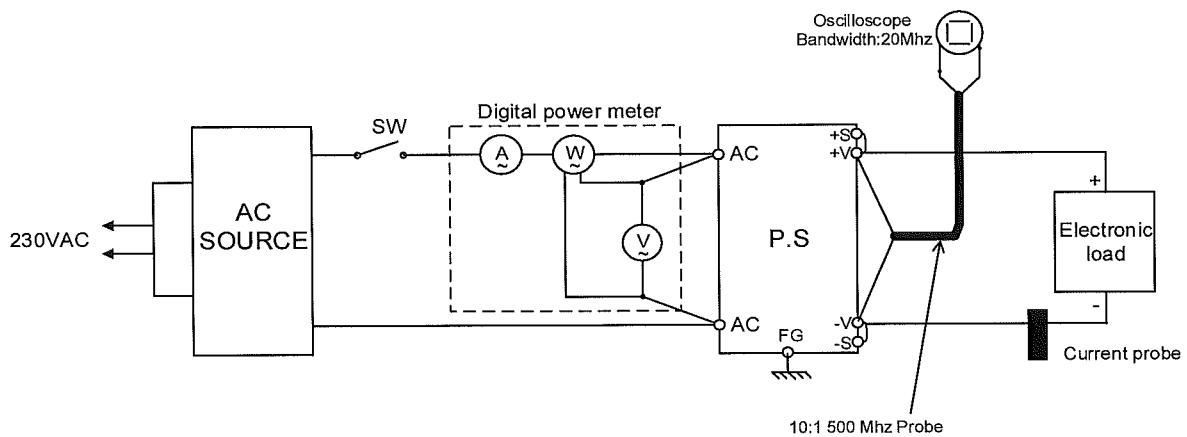

1.1 Circuit used for determination

(12) Output Voltage ripple & noise waveform 160V up to 650V models

(b) Normal + Common mode

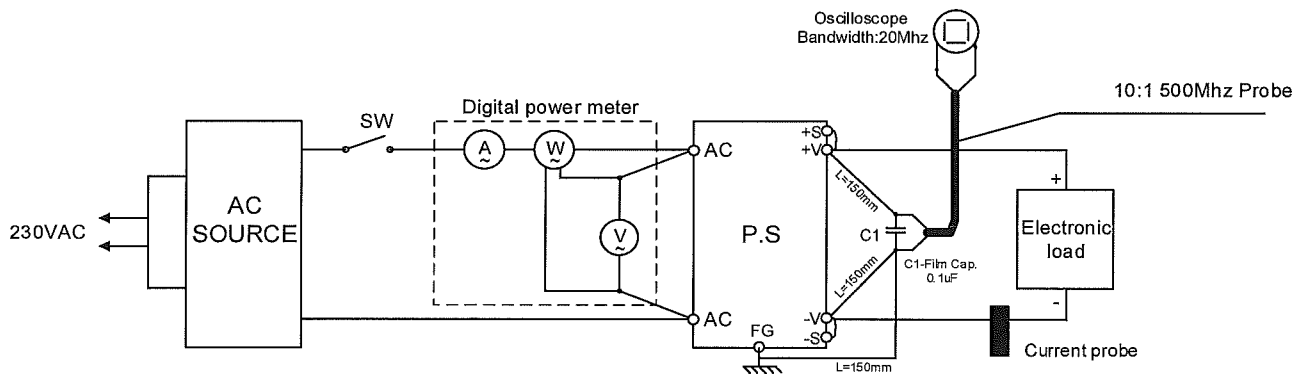

(13) Output Current rms ripple 160V to 650V models

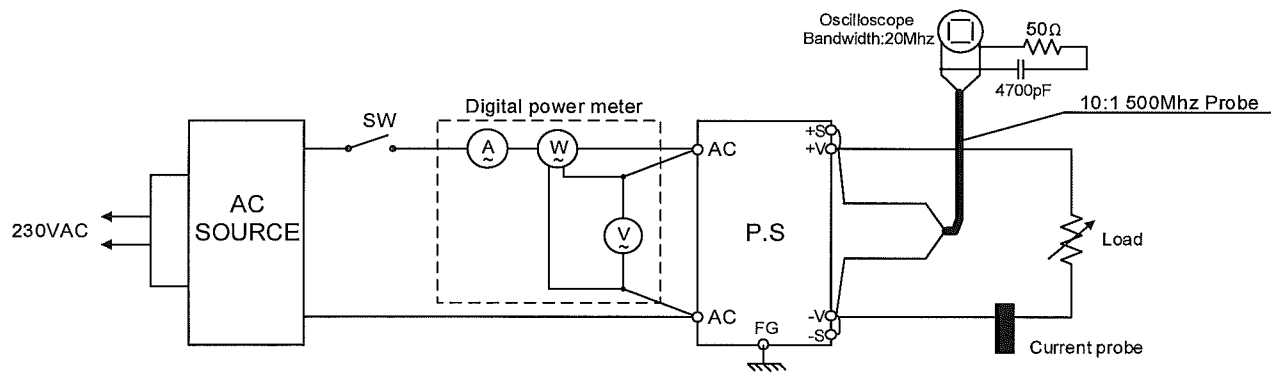

Notes:

(*) Output Current rms ripple = Output Voltage rms ripple divided by the Load resistance.

1.2 List of equipment used

	EQUIPMENT USED	MANUFACTURER	MODEL No.
1	Digital oscilloscope	YOKOGAWA	DL1740 E/EL
2	Digital multimeter	AGILENT	34401A
3	Digital power meter	YOKOGAWA	WT230 / WT110
4	AC source	CHROMA	6590/6463/6520/6530
5	Electronic load	H&H	ZS1880/ZS7060/ZS4260
6	Electronic load	CHROMA	63202 / 63204
7	Leakage current tester	KIKUSUI	TOS3200
8	Voltage probe	YOKOGAWA	701939/701944
9	Current probe	YOKOGAWA	701933
10	Inrush Current Meter	TAKAMISAWA	PSA-210
11	Data acquisition / switch unit	AGILENT	34970A
12	Controlled temp. chamber	THERMOTRON	SM-16-3800
13	Controlled temp. chamber	THERMOTRON	SM-16-8200
14	Controlled temp. chamber	THERMOTRON	SE-600-5-5
15	Controlled temp. chamber	THERMOTRON	SE-600-6-6

2. CHARACTERISTIC

Z200 H.V

2.1 Steady state data

(1) Regulation - Line & Load, Temperature drift

Z160-1.3

Conditions: $T_a = 25^\circ\text{C}$

1. Regulation - Line & Load, C.V mode (Readings in [V])

Io	Vin (AC)				Line Regulation	
	85	100	200	265		
0%	159.9978	159.9977	159.9975	159.9980	0.5	0.000
25%	159.9974	159.9975	159.9974	159.9977	0.3	0.000
50%	159.9973	159.9967	159.9970	159.9972	0.6	0.000
75%	159.9970	159.9969	159.9970	159.9971	0.2	0.000
100%	159.9968	159.9971	159.9967	159.9972	0.5	0.000
Load Regulation	1.0	1.0	0.8	0.9	$\Delta V(\text{mV})$	(%)
	0.001	0.001	0.001	0.001	(%)	

2. Temperature drift, C.V mode

Conditions: $V_{in}: 100\text{Vac}$
 $I_{out}: 100\%$

Ta	0°C	25°C	50°C	Temp. Coefficient (0°C~50°C)	
Vout	159.996	159.984	159.995	12 mV	3 ppm/°C

2.1 Steady state data

(1) Regulation - Line & Load, Temperature drift

Z650-0.32

Conditions: Ta = 25°C

1. Regulation - Line & Load, C.V mode (Readings in [V])

Io	Vin (AC)				Line Regulation	
	85	100	200	265		
0%	649.9770	649.9788	649.9795	649.9808	3.8	0.001
25%	649.9814	649.9820	649.9816	649.9826	1.2	0.000
50%	649.9820	649.9824	649.9821	649.9832	1.2	0.000
75%	649.9821	649.9833	649.9823	649.9837	1.6	0.000
100%	649.9813	649.9830	649.9810	649.9827	2.0	0.000
Load Regulation	5.1	4.5	2.8	2.9	$\Delta V(mV)$	(%)
	0.001	0.001	0.000	0.000	(%)	

2. Temperature drift, C.V mode

Conditions: Vin:100Vac
Iout:100%

Ta	0°C	25°C	50°C	Temp. Coefficient (0°C~50°C)	
Vout	650.026	649.996	649.992	34 mV	1 ppm/°C

2.1 Steady state data

(1) Regulation - Line & Load, Temperature drift

Z160-1.3

Conditions: Ta = 25°C

1. Regulation - Line & Load, C.C mode (*) (Readings in [A])

Vo	Vin (AC)				Line Regulation	
	85	100	200	265		
0%	1.2995	1.2995	1.2995	1.2995	0.0	0.000
25%	1.2995	1.2995	1.2995	1.2995	0.0	0.000
50%	1.2995	1.2995	1.2995	1.2995	0.0	0.000
75%	1.2994	1.2994	1.2994	1.2994	0.0	0.000
100%	1.2994	1.2994	1.2994	1.2994	0.0	0.000
Load Regulation	0.1	0.1	0.1	0.1	$\Delta I(\text{mA})$	(%)
	0.008	0.008	0.008	0.008	(%)	

Notes:

(*) Not including load regulation thermal drift effect.

2. Temperature drift, C.C mode

Conditions: Vin:100Vac
Iout:100%

Ta	0°C	25°C	50°C	Temp. Coefficient (0°C~50°C)	
Iout	1.2995	1.3000	1.2990	1.0 mA	30 ppm/°C

2.1 Steady state data

(1) Regulation - Line & Load, Temperature drift

Z650-0.32

Conditions: Ta = 25°C

1. Regulation - Line & Load, C.C mode (*) (Readings in [A])

Vo	Vin (AC)				Line Regulation	
	85	100	200	265		
Short	0.3200	0.3200	0.3201	0.3201	0.01	0.003
25%	0.3200	0.3200	0.3200	0.3200	0.01	0.003
50%	0.3200	0.3200	0.3200	0.3200	0.01	0.003
75%	0.3199	0.3200	0.3200	0.3200	0.02	0.006
100%	0.3199	0.3199	0.3199	0.3199	0.01	0.003
Load Regulation	0.1	0.1	0.1	0.1	ΔI (mA)	(%)
	0.034	0.034	0.038	0.041	(%)	

Notes:

(*) Not including load regulation thermal drift effect.

2. Temperature drift, C.C mode

Conditions: Vin:100Vac
Iout:100%

Ta	0°C	25°C	50°C	Temp. Coefficient (0°C~50°C)	
Iout	0.3204	0.3204	0.3206	0.2 mA	10 ppm/°C

2.1 Steady state data

(2) Output voltage and ripple voltage v.s input voltage

C.V mode

Conditions: Iout:100%

Z160-1.3

Ta: 0°C -----
 25°C -----
 50°C -----

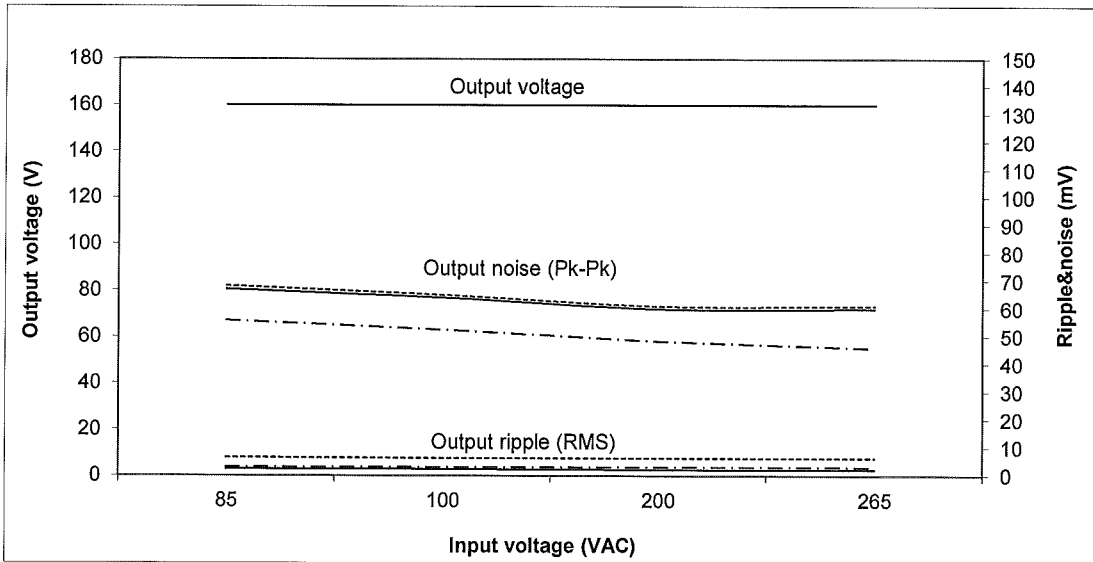

(3) Output current and ripple current v.s input voltage

C.C mode

Conditions: Vout:100%

Z160-1.3

Ta: 0°C -----
 25°C -----
 50°C -----

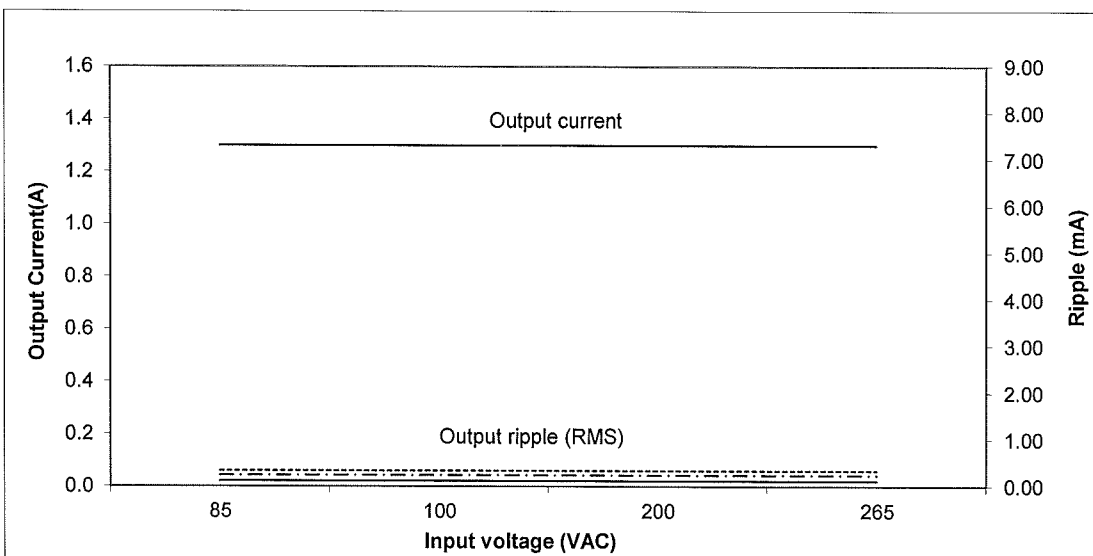

2.1 Steady state data

(2) Output voltage and ripple voltage v.s input voltage

C.V mode

Conditions: Iout:100%

Z650-0.32

Ta: 0°C -----
 25°C -.-.-.-.-
 50°C _____

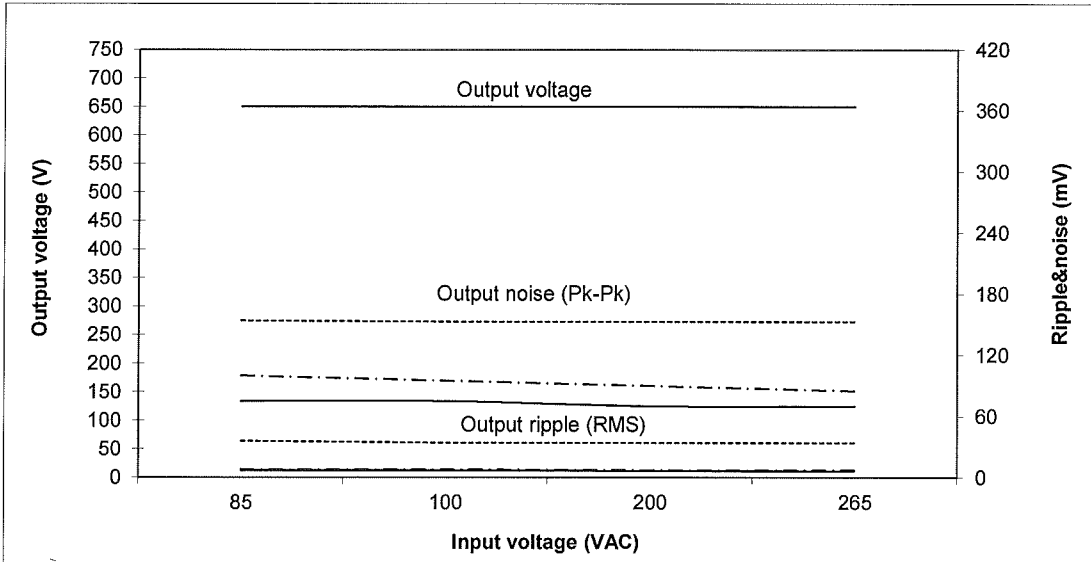

(3) Output current and ripple current v.s input voltage

C.C mode

Conditions: Vout:100%

Z650-0.32

Ta: 0°C -----
 25°C -.-.-.-.-
 50°C _____

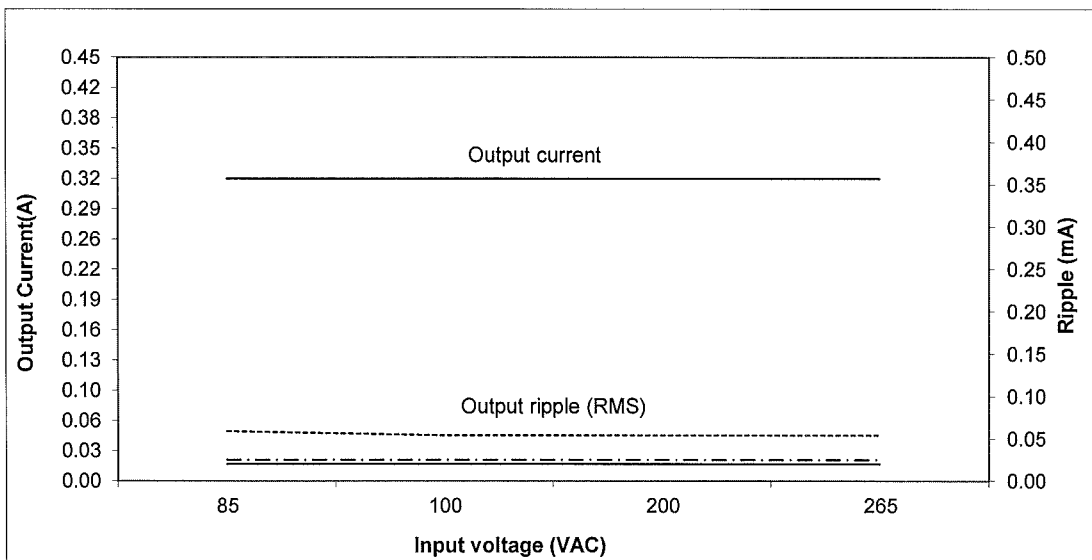

2.1 Steady state data

(4) Efficiency and Input current vs. Output current

Conditions:

- Vin: 85 VAC -----
- 100VAC —————
- 200 VAC - - - - -
- 265 VAC - - - - -
- Vout:100%
- Ta: 25°C

Z160-1.3

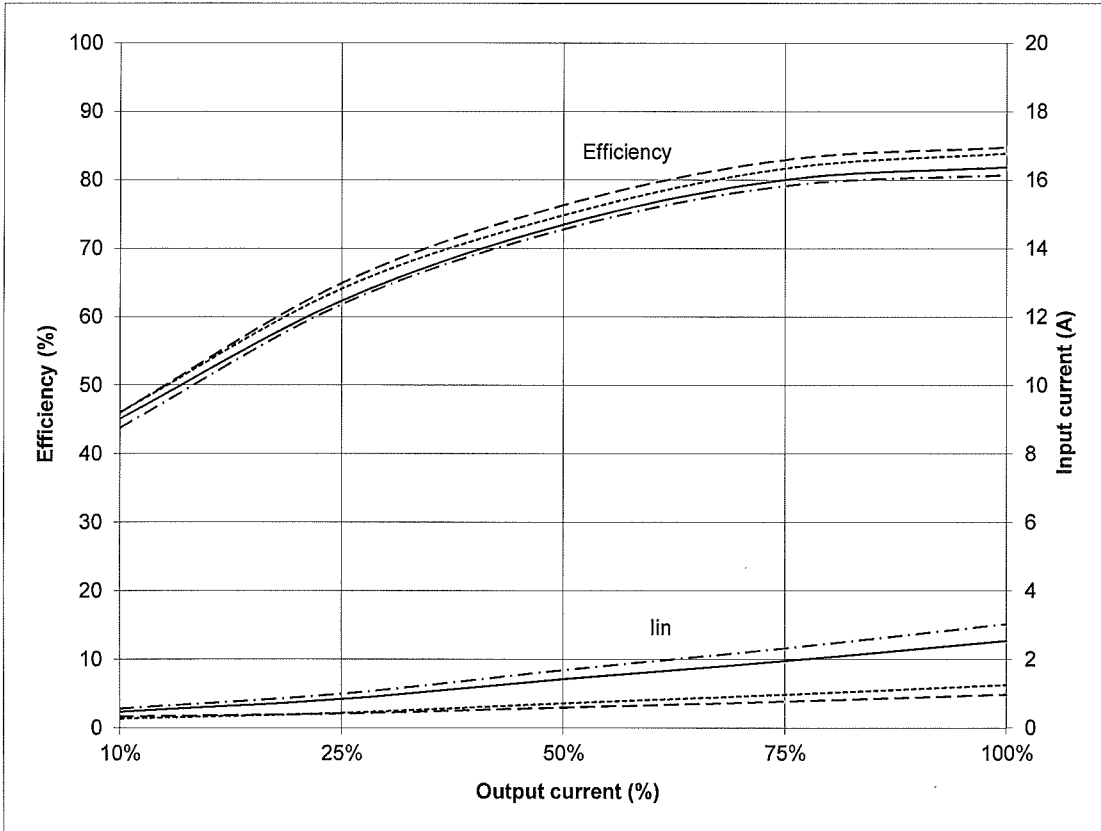

2.1 Steady state data

(4) Efficiency and Input current vs. Output current

Conditions:

Vin: 85 VAC
 100VAC
 200 VAC
 265 VAC
 Vout:100%
 Ta: 25°C

Z650-0.32

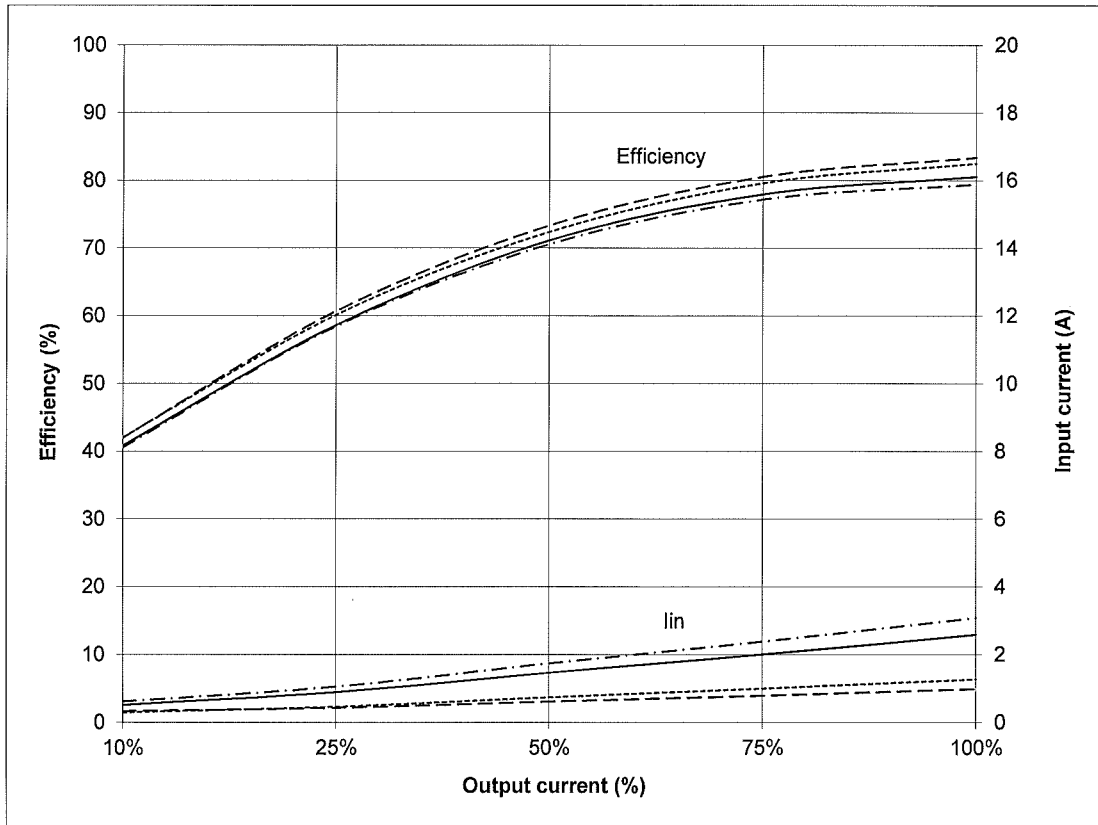

2.2 Warm up drift & stability

Conditions: V_{in} :100Vac
 V_{out} : 100%
 I_{out} : 100%
 $T_a = 25^\circ\text{C}$

C.V mode

Z160-1.3

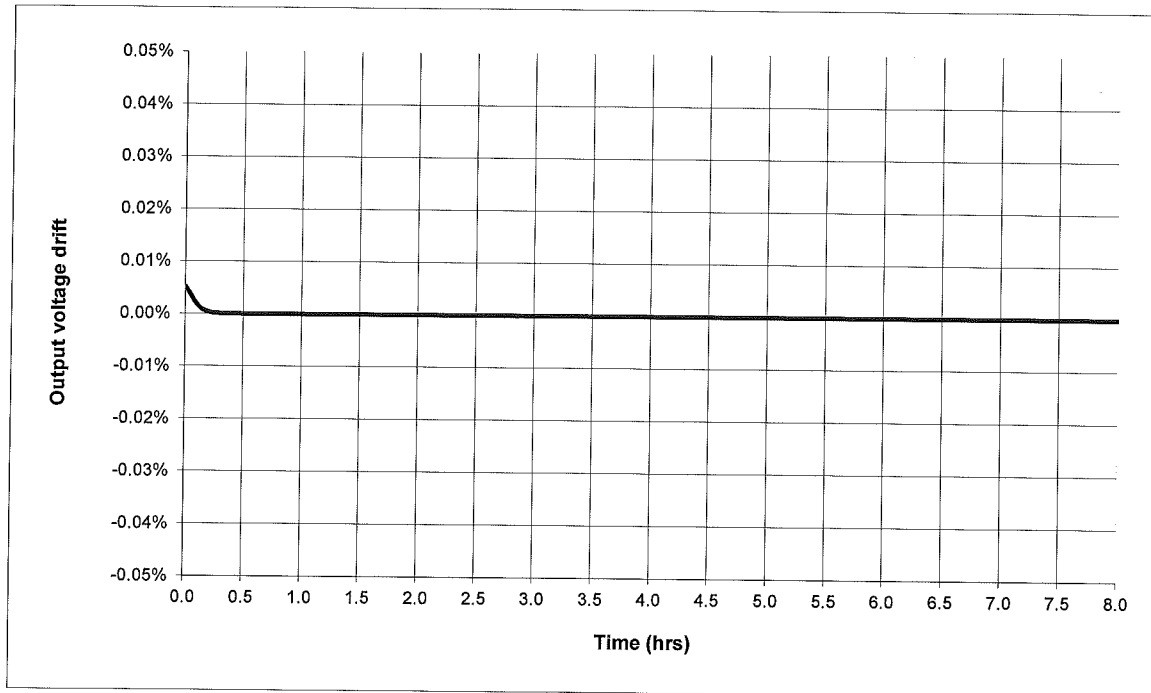

C.C mode

Z160-1.3

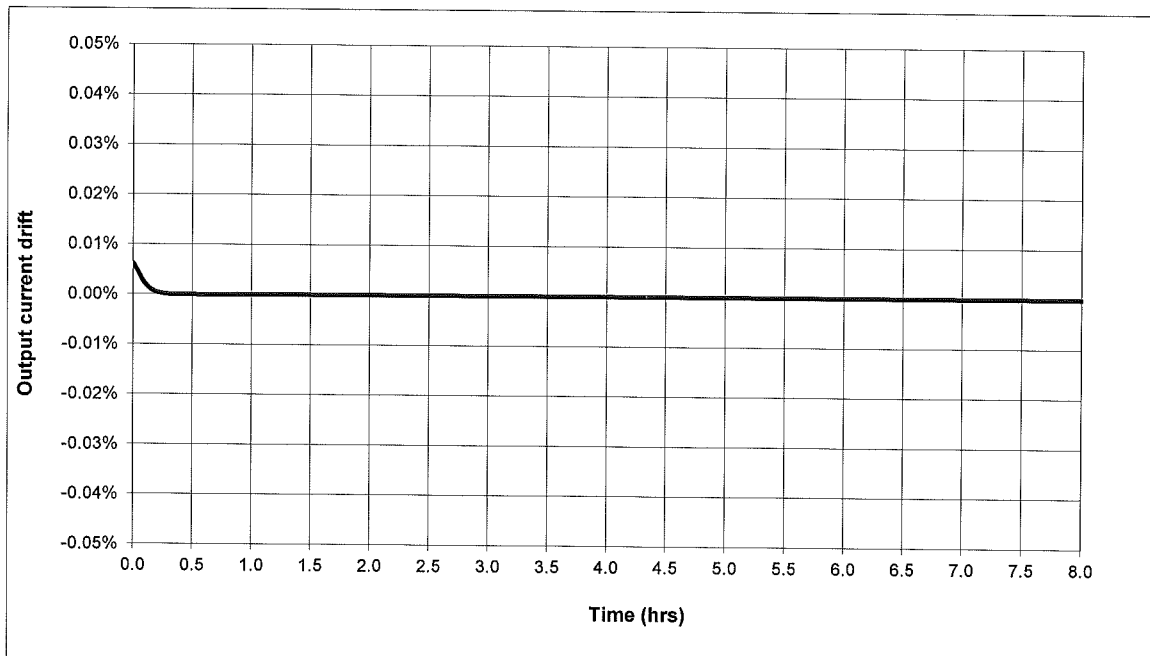

2.2 Warm up drift & stability

Conditions: Vin: 100Vac
Vout: 100%
Iout: 100%
Ta = 25°C

C.V mode

Z650-0.32

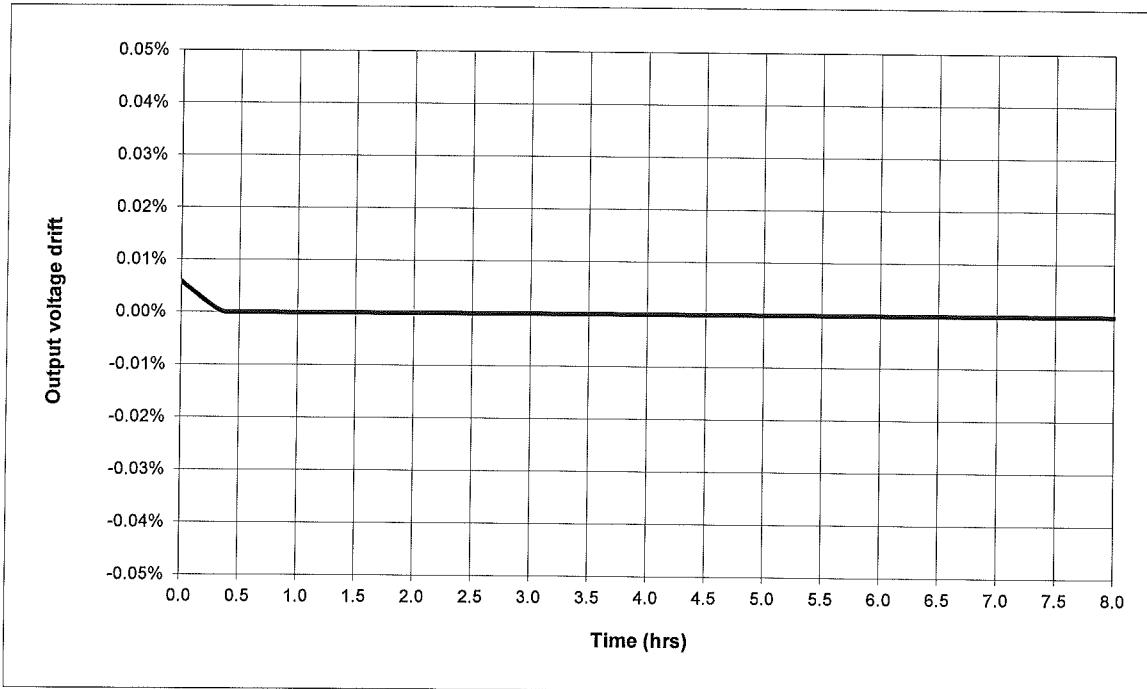

C.C mode

Z650-0.32

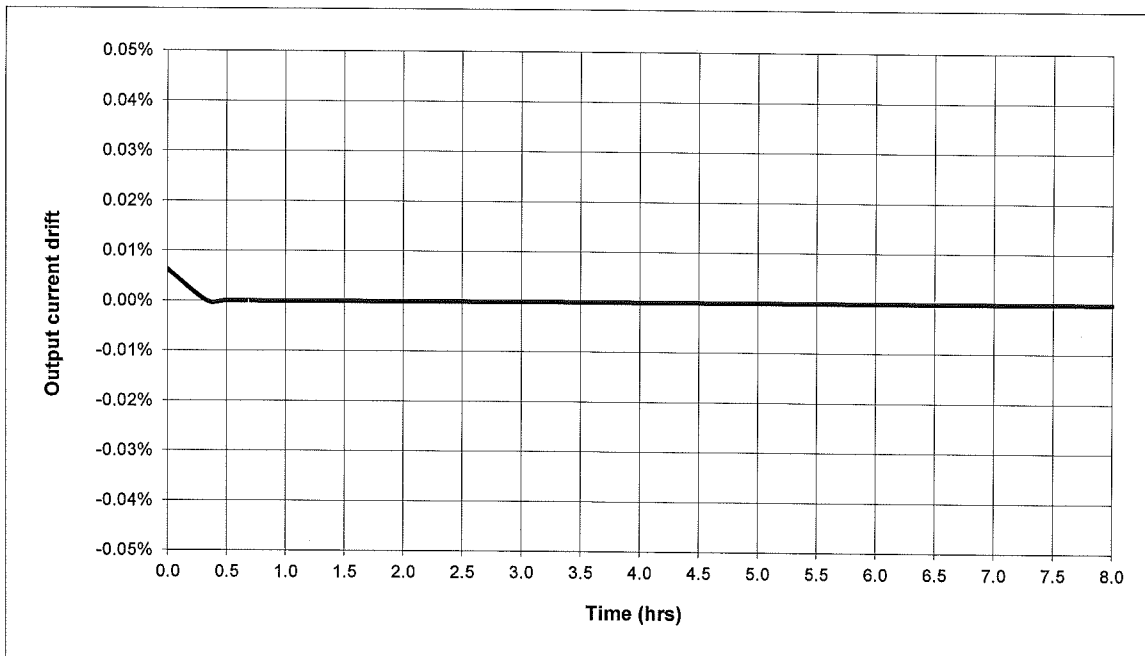

2.3 Over voltage protection (OVP) characteristics

Conditions: V_{in} : 100Vac

I_{out} : 0%

$T_a = 25^\circ\text{C}$

Z160-1.3

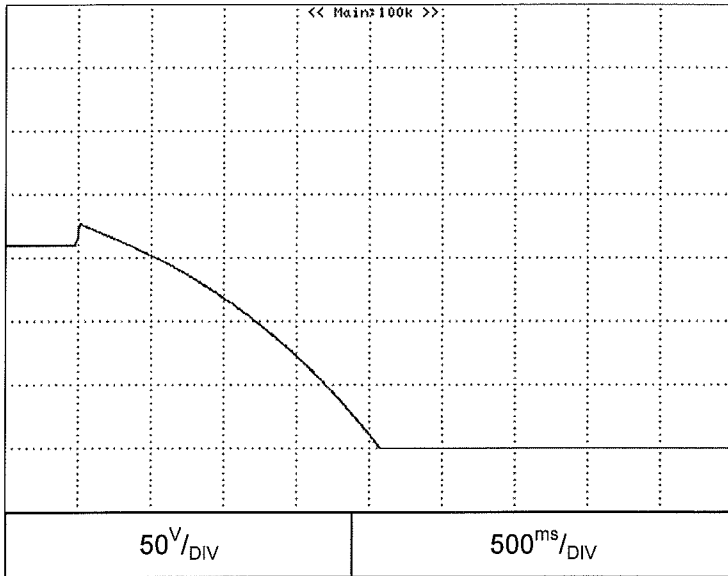

OVP setting: 176V

Z650-0.32

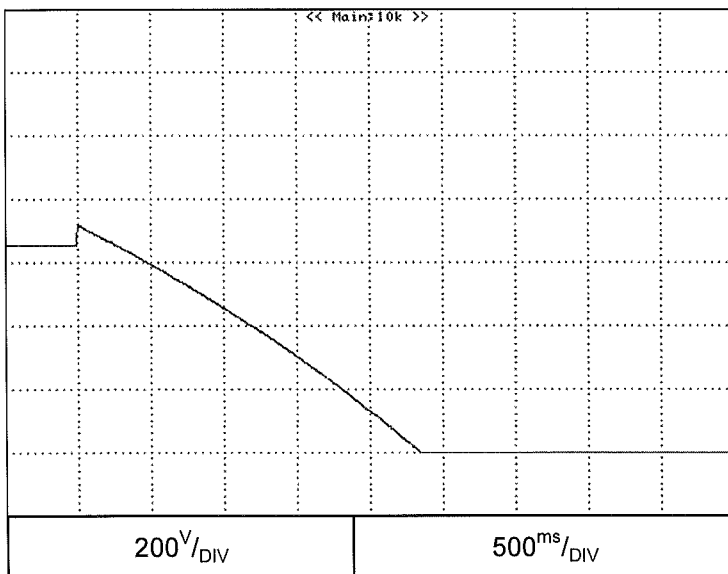

OVP setting: 717V

2.4 ON/OFF Output rise characteristics

Conditions: Vin:100Vac
Vout: 100%
Iout: 0%
Iset=105%
Ta = 25°C

C.V mode

Z160-1.3

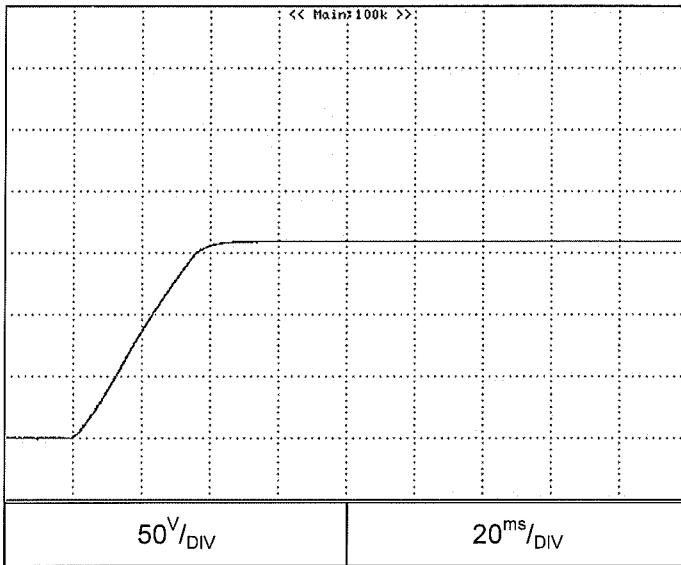

Z650-0.32

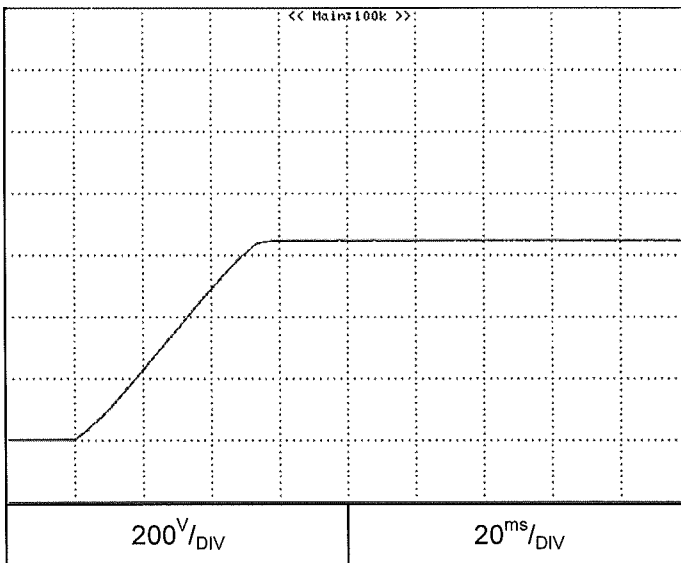

2.4 ON/OFF Output rise characteristics

C.V mode

Conditions: Vin:100Vac
Vout: 100%
Iout: 100%
Iset=105%
Load: CR
Ta = 25°C

Z160-1.3

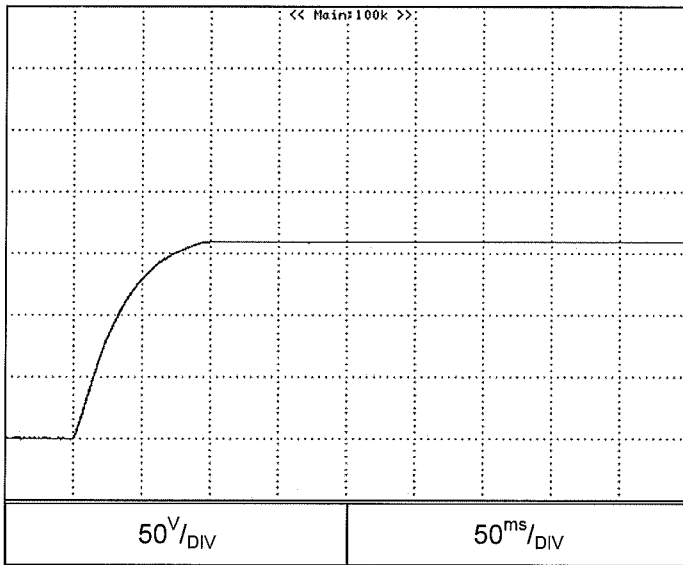

Z650-0.32

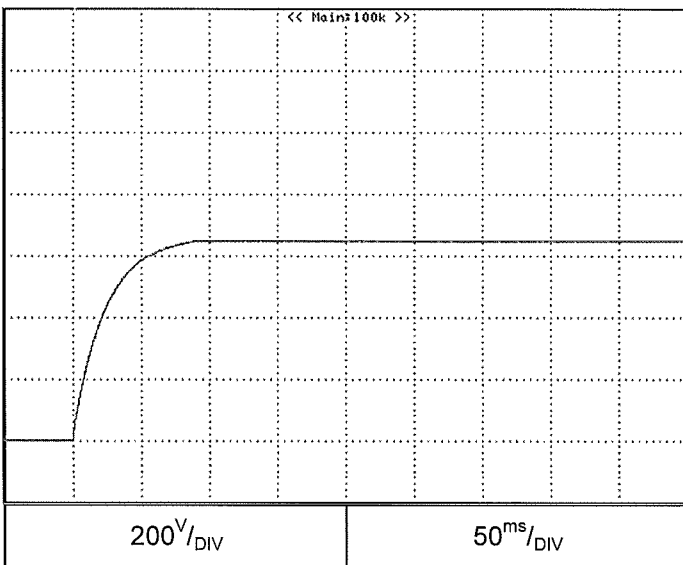

2.4 ON/OFF Output rise characteristics

C.C mode

Conditions: Vin:100Vac
Vout: 100%
Iout: 100%
Vset=105%
Load: CR
Ta = 25°C

Z160-1.3

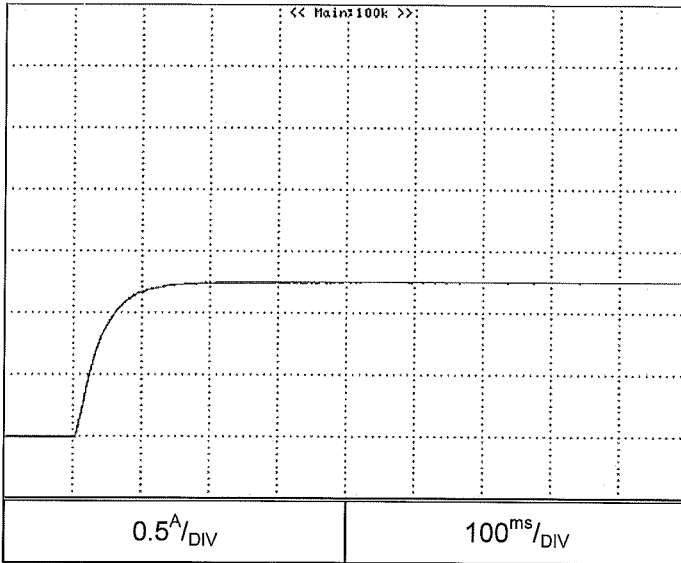

Z650-0.32

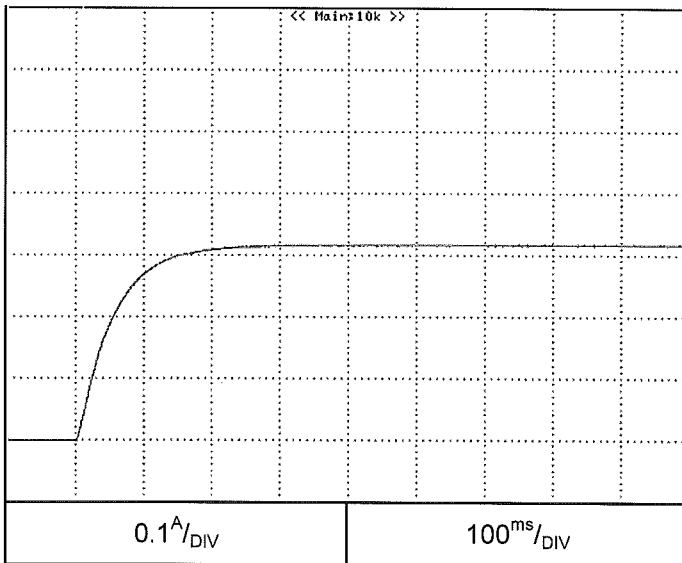

2.4 ON/OFF Output rise characteristics

C.C mode

Conditions: V_{in} : 100Vac
 I_{out} : 100%
 V_{set} =105%
shorted output
 $T_a = 25^\circ\text{C}$

Z160-1.3

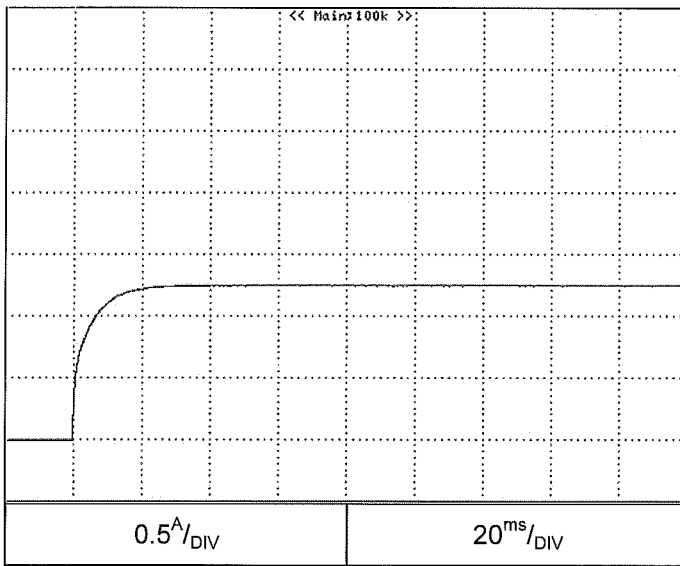

Z650-0.32

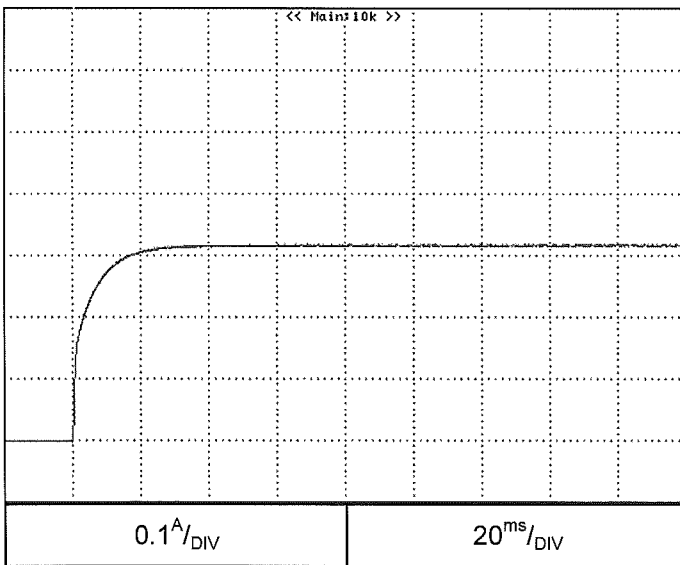

2.5 ON/OFF Output fall characteristics

C.V mode

Conditions: Vin:100Vac
Vout: 100%
Iout: 0%
Iset=105%
Ta = 25°C

Z160-1.3

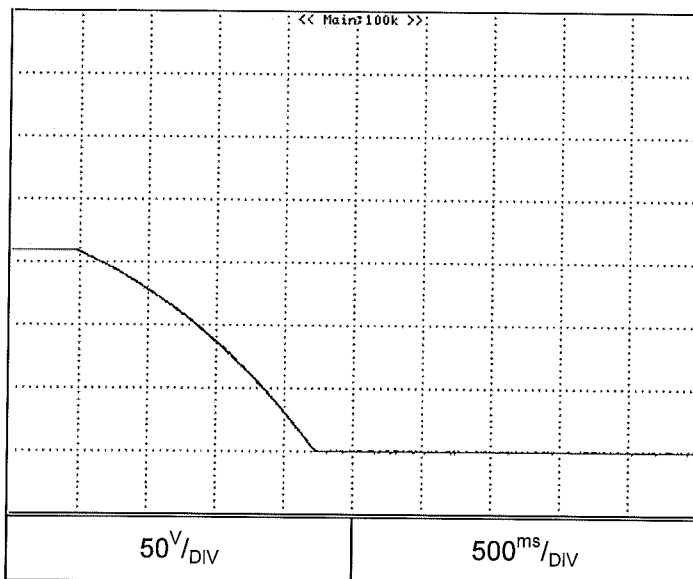

Z650-0.32

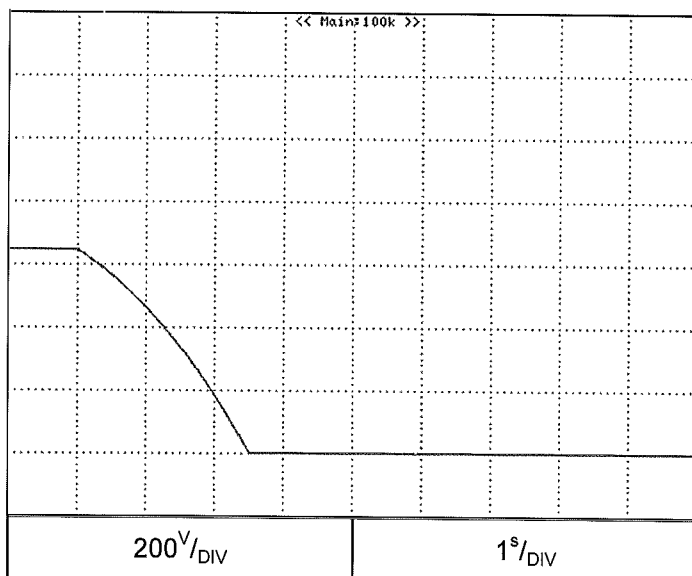

2.5 ON/OFF Output fall characteristics

C.V mode

Conditions: Vin:100Vac
Vout: 100%
Iout: 100%
Iset=105%
Load: CR
Ta = 25°C

Z160-1.3

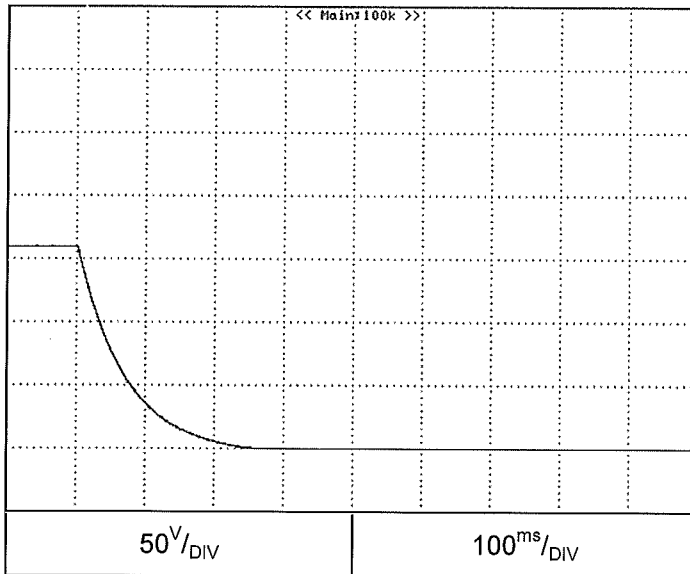

Z650-0.32

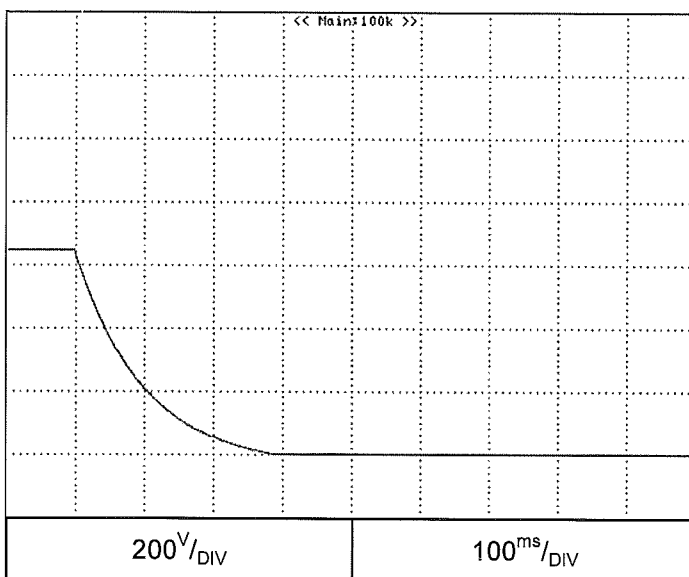

2.5 ON/OFF Output fall characteristics

Conditions: Vin:100Vac
Vout: 100%
Iout: 100%
Vset=105%
Load: CR
Ta = 25°C

C.C mode

Z160-1.3

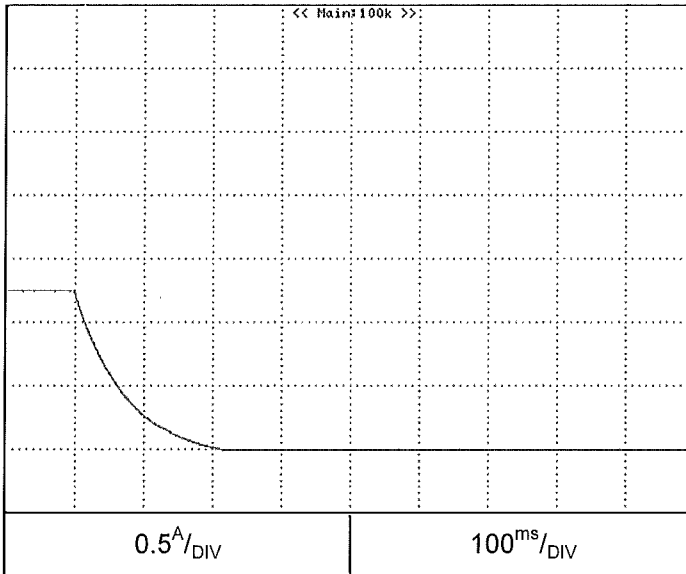

Z650-0.32

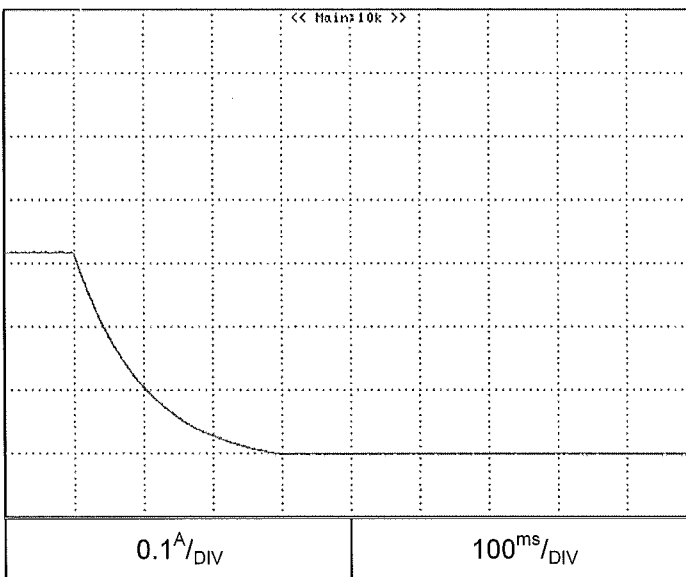

2.5 ON/OFF Output fall characteristics

C.C mode

Conditions: Vin:100Vac
Iout: 100%
Vset=105%
shorted output
Ta = 25°C

Z160-1.3

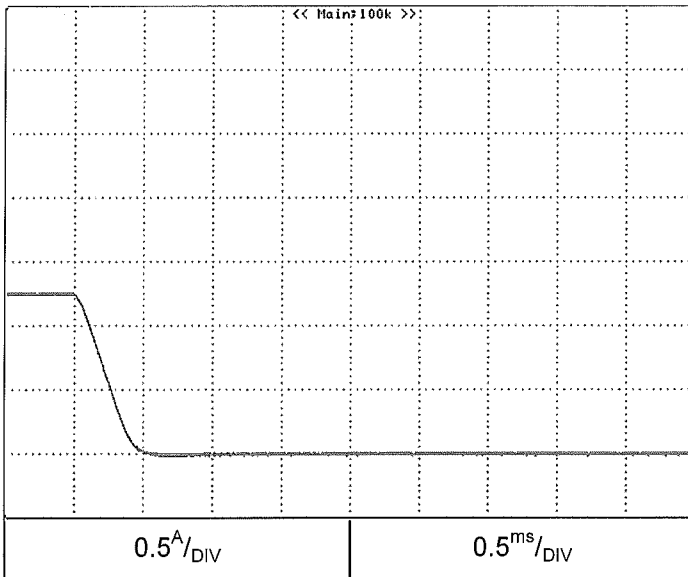

Z650-0.32

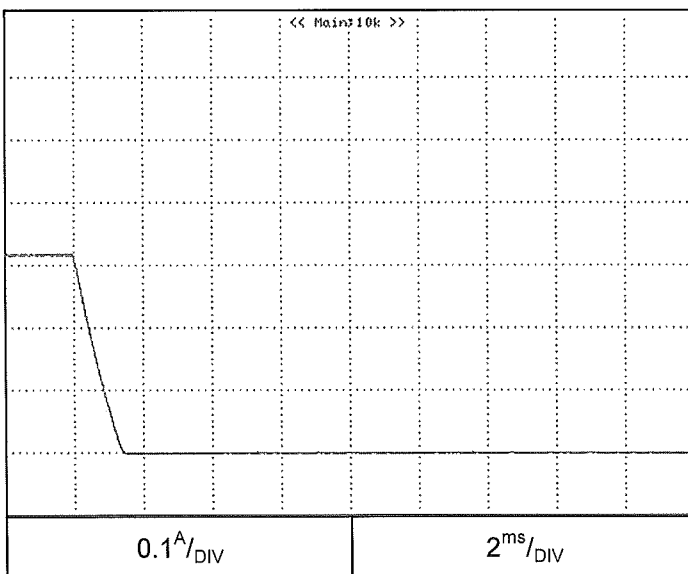

2.6 Hold up time characteristics

Conditions: V_{in} : 100Vac
 V_{out} : 100%
 T_a = 25°C

Z160-1.3

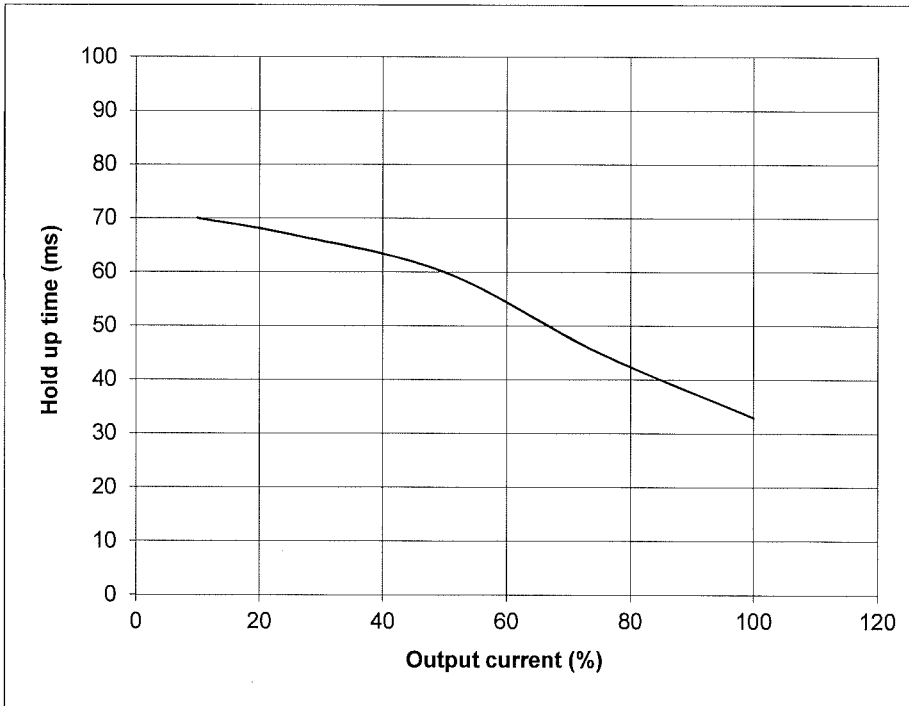

2.6 Hold up time characteristics

Conditions: V_{in} : 100Vac
 V_{out} : 100%
 $T_a = 25^\circ\text{C}$

Z650-0.32

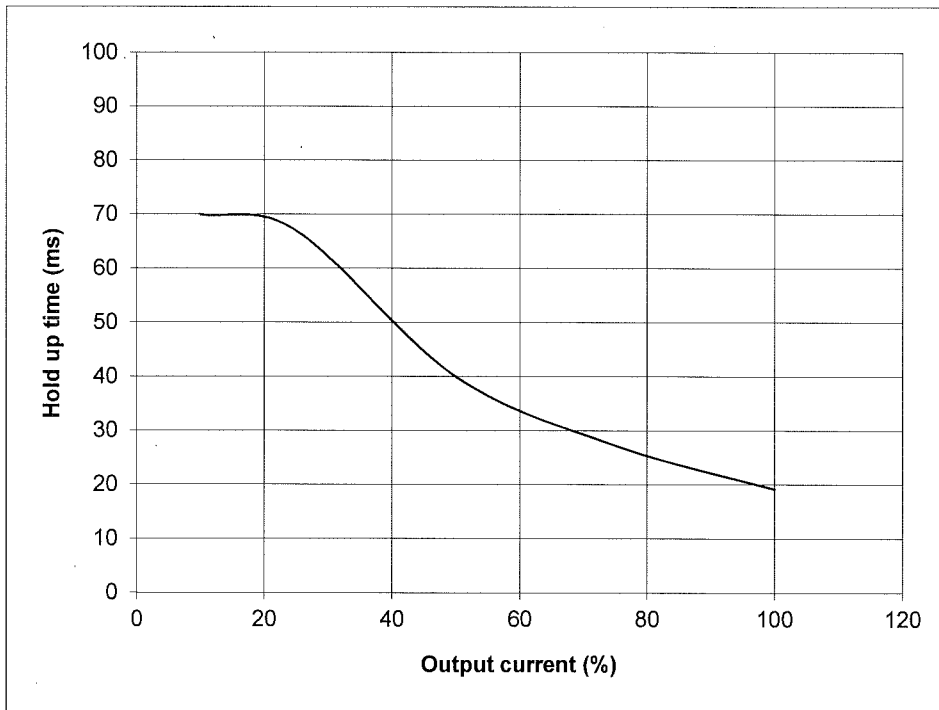

2.7 Dynamic line response characteristics

Conditions: Vin:85↔132V

Vout: 100%

Iout: 100%

Ta = 25°C

C.V mode

Z160-1.3

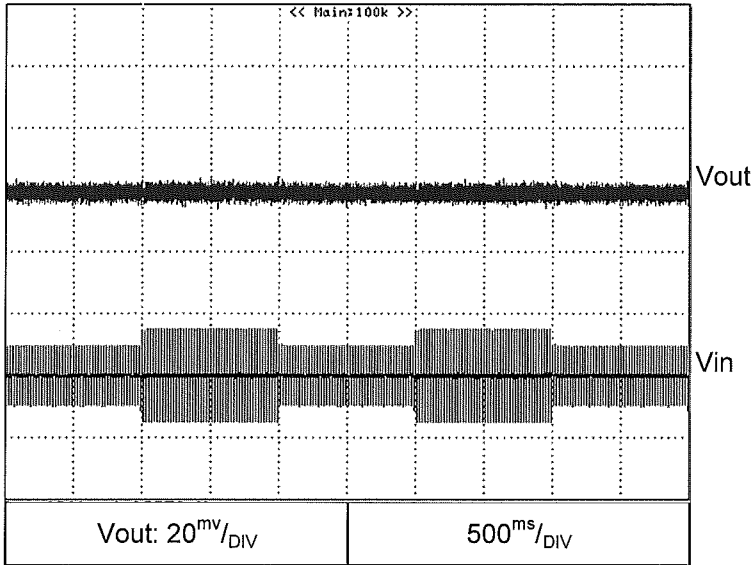

Conditions: Vin:170↔265V

Vout: 100%

Iout: 100%

Ta = 25°C

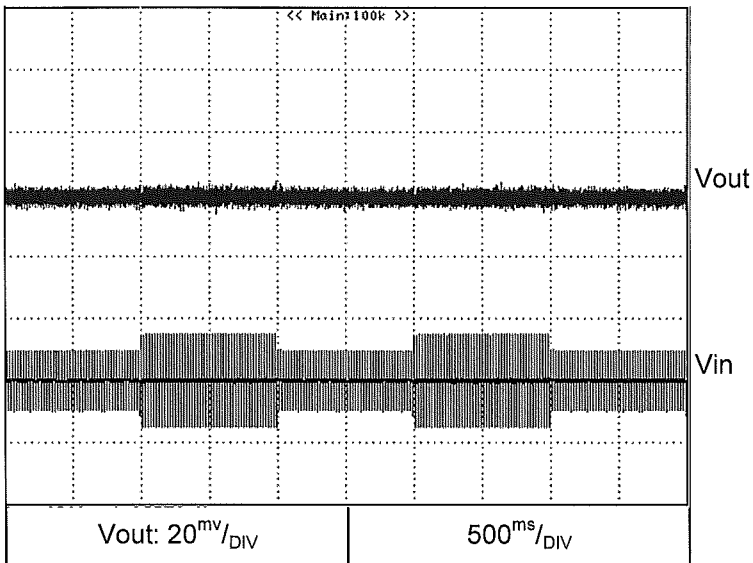

2.7 Dynamic line response characteristics

Conditions: $V_{in}: 85 \leftrightarrow 132V$

$V_{out}: 100\%$

$I_{out}: 100\%$

$T_a = 25^\circ C$

C.V mode

Z650-0.32

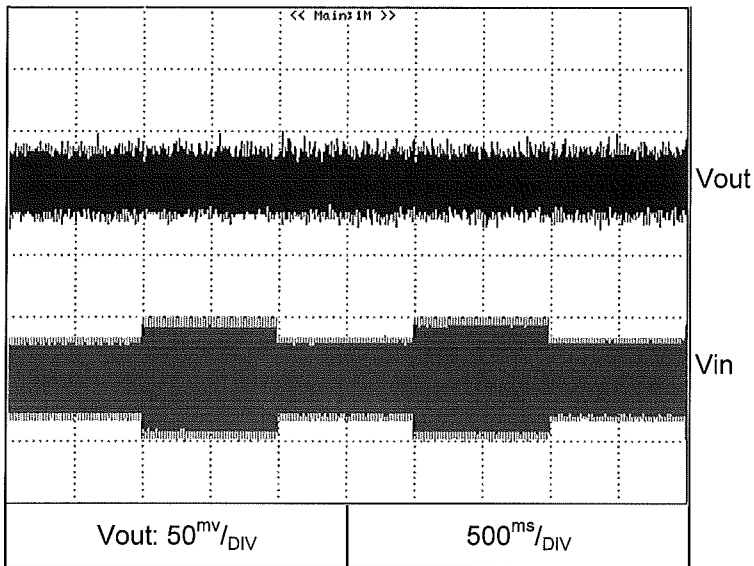

Conditions: $V_{in}: 170 \leftrightarrow 265V$

$V_{out}: 100\%$

$I_{out}: 100\%$

$T_a = 25^\circ C$

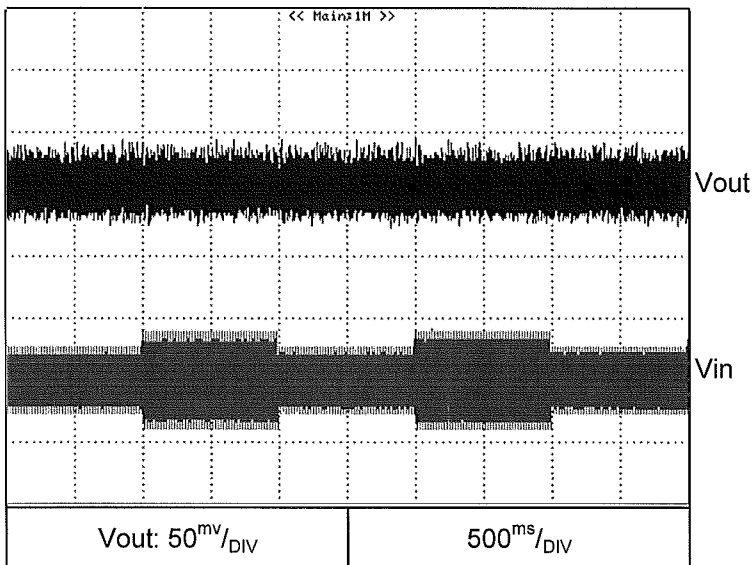

2.7 Dynamic line response characteristics

Conditions: $V_{in}: 85 \leftrightarrow 132V$
 $V_{out}: 100\%$
 $I_{out}: 100\%$
 $T_a = 25^\circ C$

C.C mode

Z160-1.3

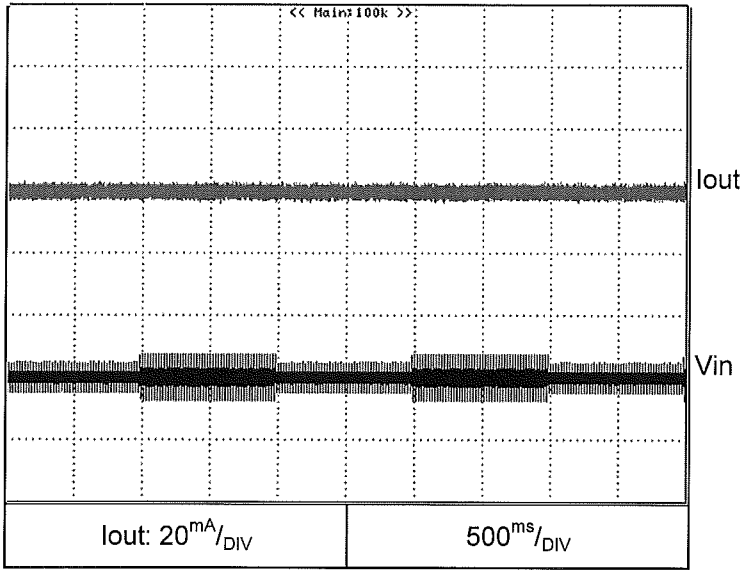

Conditions: $V_{in}: 170 \leftrightarrow 265V$
 $V_{out}: 100\%$
 $I_{out}: 100\%$
 $T_a = 25^\circ C$

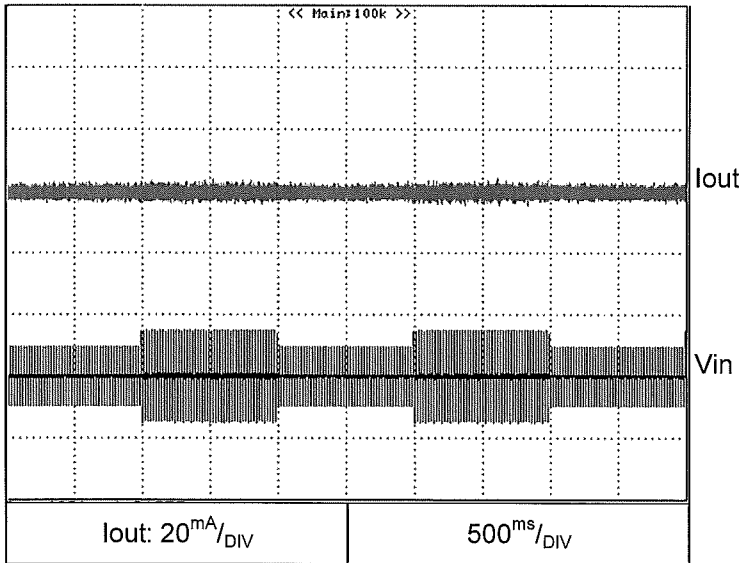

2.7 Dynamic line response characteristics

C.C mode

Conditions: $V_{in}: 85 \leftrightarrow 132V$

$V_{out}: 100\%$

$I_{out}: 100\%$

$T_a = 25^{\circ}C$

Z650-0.32

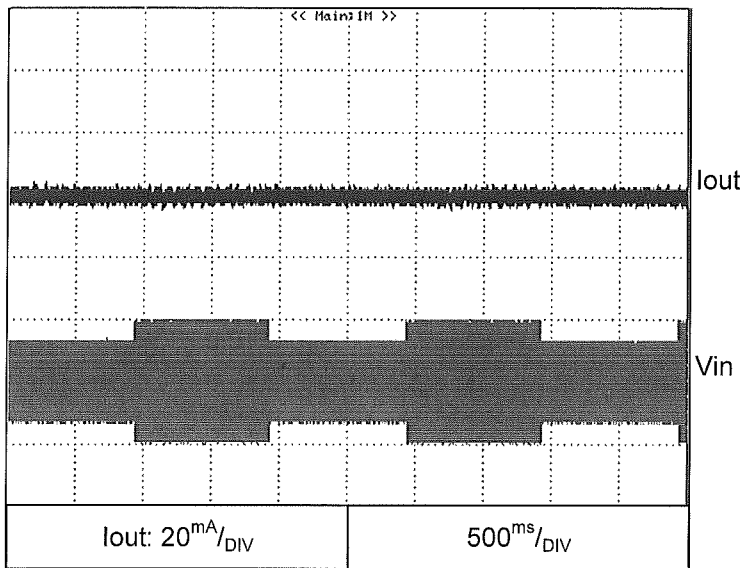

Conditions: $V_{in}: 170 \leftrightarrow 265V$

$V_{out}: 100\%$

$I_{out}: 100\%$

$T_a = 25^{\circ}C$

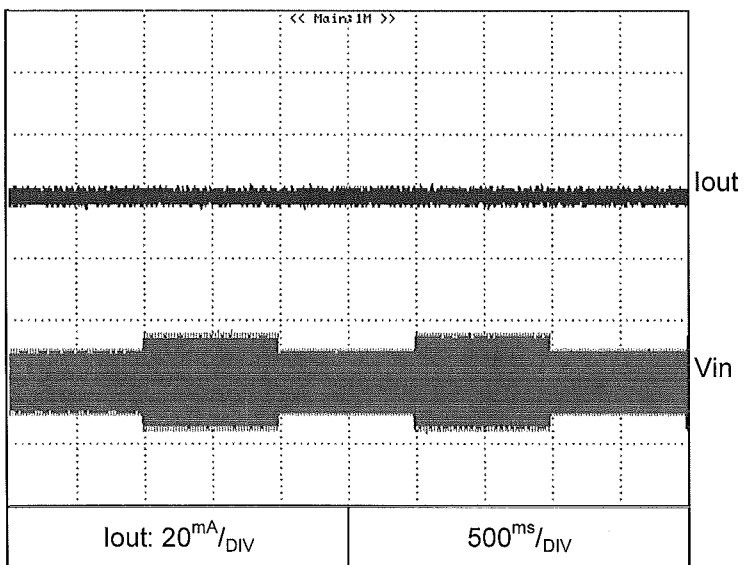

2.8 Dynamic load response characteristics

Conditions: V_{in} : 100Vac
 V_{out} : 100%
 $T_a = 25^\circ\text{C}$

C.V mode

Load current: $t_r = t_f = 100\mu\text{s}$

Z160-1.3

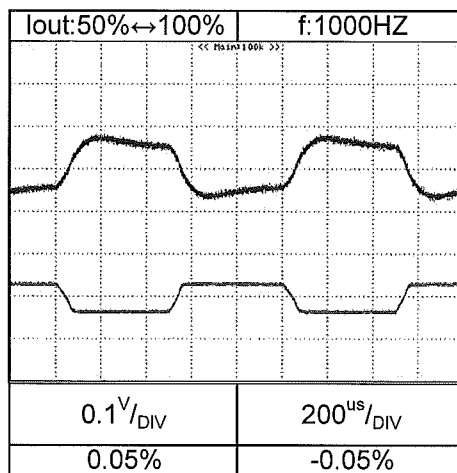
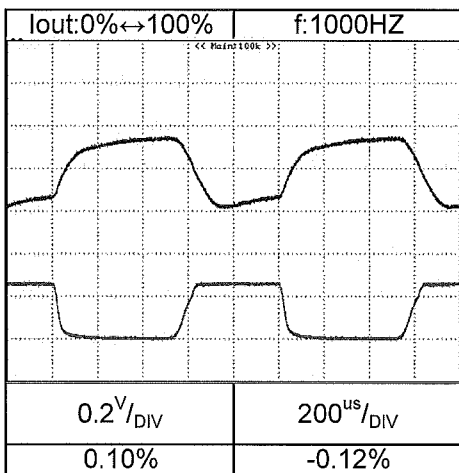
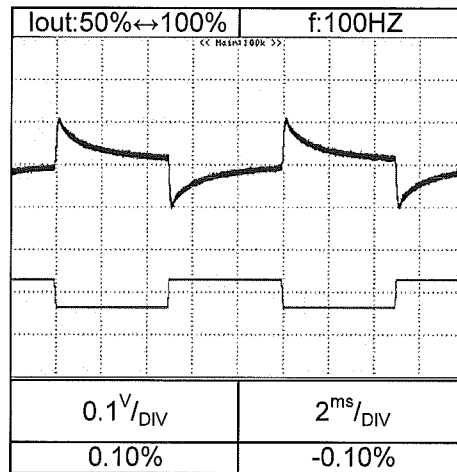
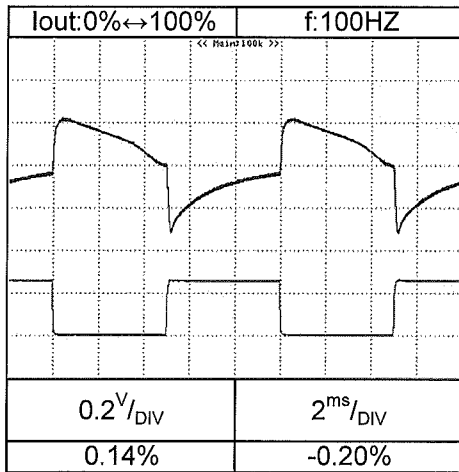

2.8 Dynamic load response characteristics

Conditions: V_{in} : 100Vac
 V_{out} : 100%
 $T_a = 25^\circ\text{C}$

C.V mode

Z650-0.32

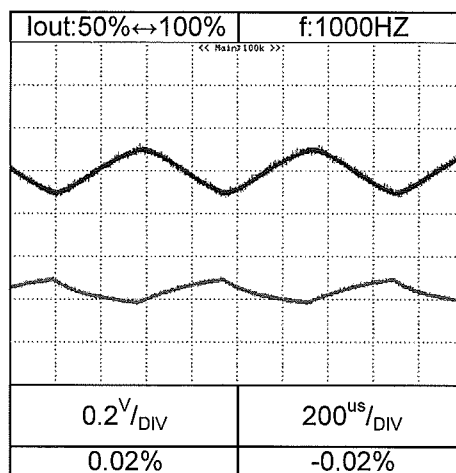
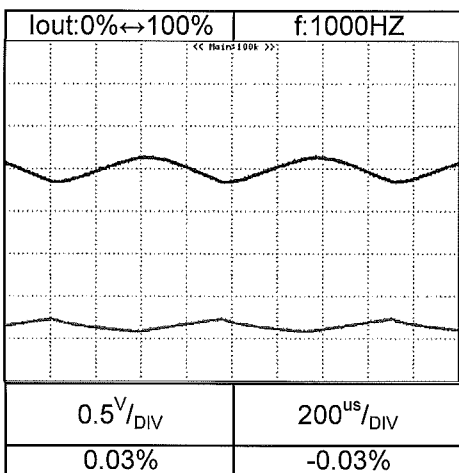
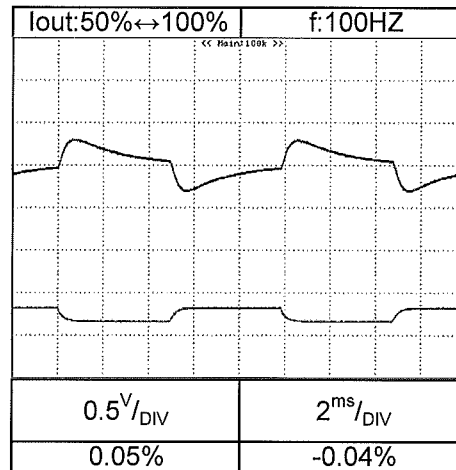
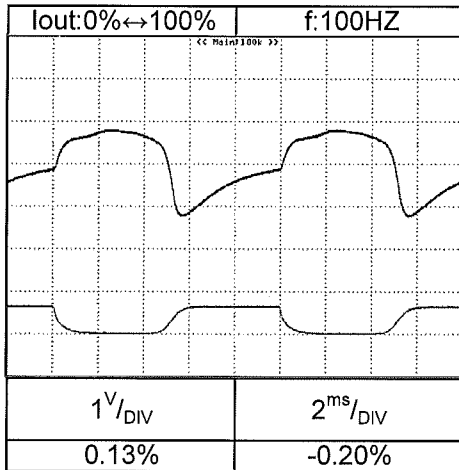

2.8 Dynamic load response characteristics

Conditions: $V_{in}: 100V_{ac}$
 $T_a = 25^{\circ}C$

C.C mode

Z160-1.3

$I_o = 1.3A$

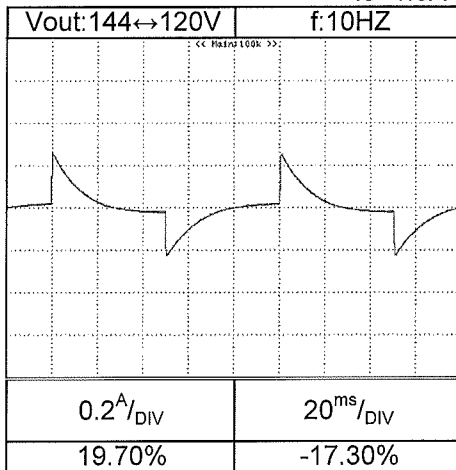

$I_o = 0.65A$

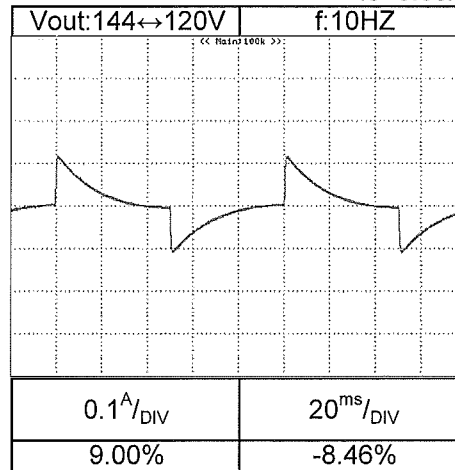

Z650-0.32

$I_o = 0.32A$

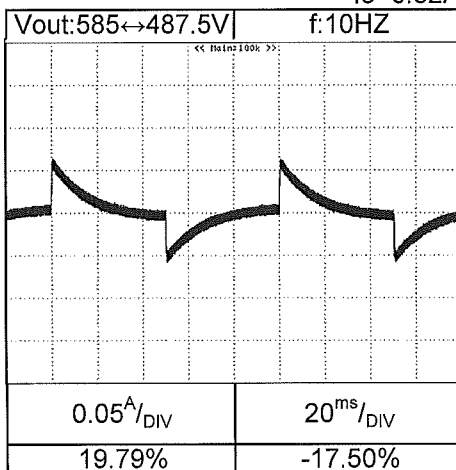

$I_o = 0.16A$

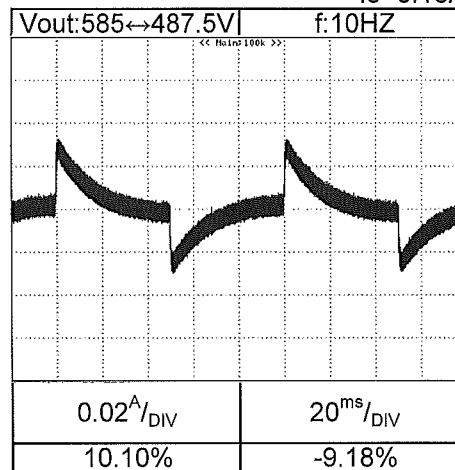

2.9 Response to brown-out characteristics

C.V mode

Conditions: V_{in} : 100VAC
 V_{out} : 100%
 I_{out} : 100%
 $T_a = 25^\circ\text{C}$

Z160-1.3

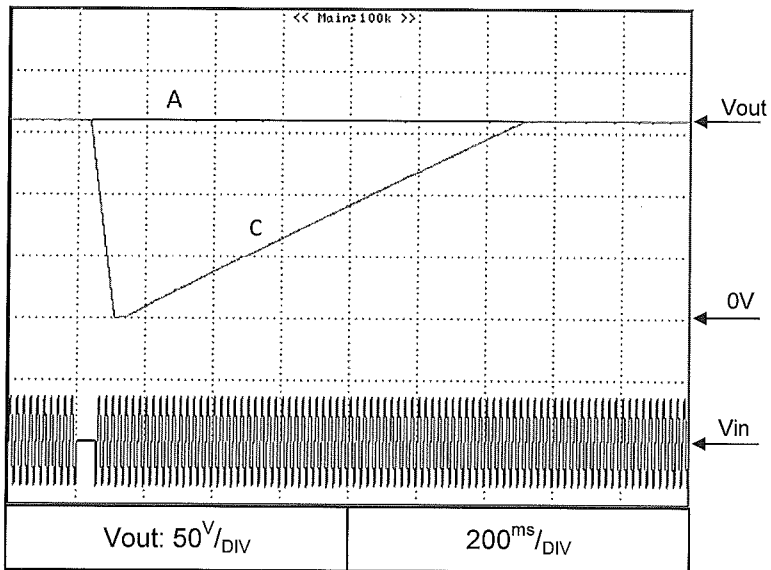

Brown-out time

A - 34mS

C - 53mS

2.9 Response to brown-out characteristics

C.V mode

Conditions: Vin: 100VAC
Vout: 100%
Iout: 100%
Ta = 25°C

Z650-0.32

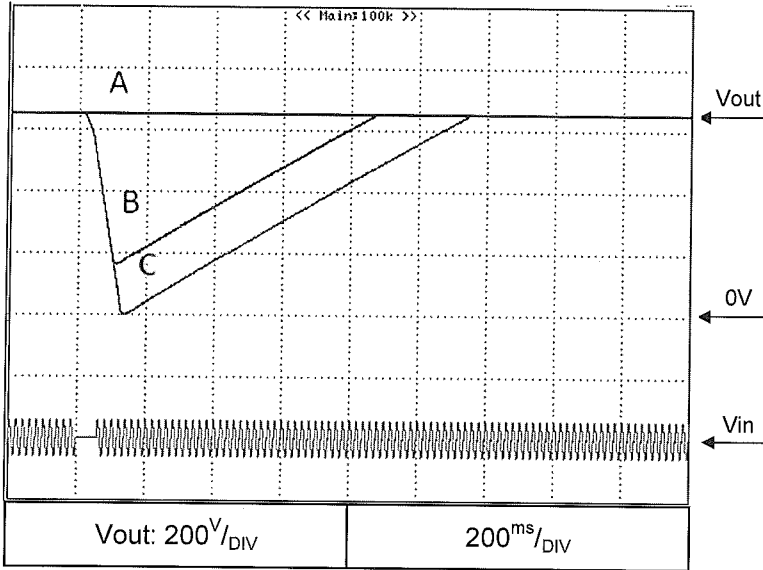

Brown-out time

A - 19ms

B - 44ms

C - 60ms

2.9 Response to brown-out characteristics

C.C mode

Conditions: Vin: 100VAC
Vout: 100%
Iout: 100%
Ta = 25°C

Z160-1.3

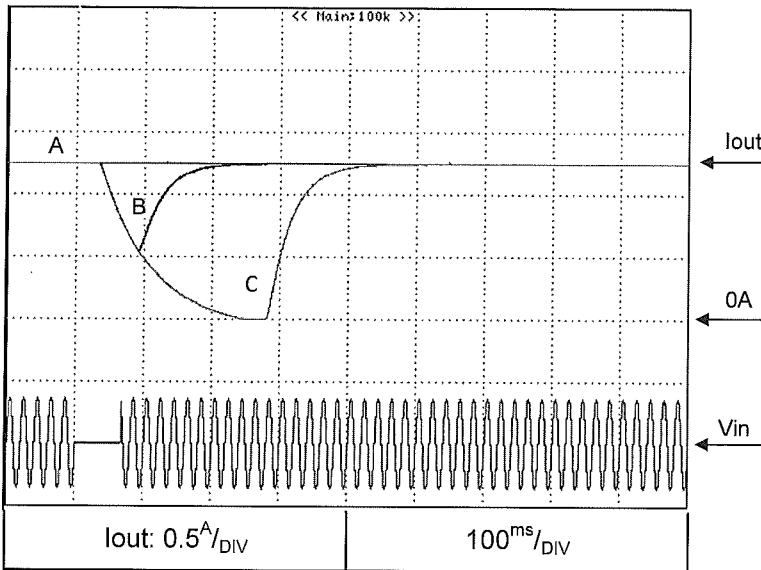

Brown-out time

A - 32mS

B - 35mS

C - 65mS

2.9 Response to brown-out characteristics

C.C mode

Conditions: V_{in} : 100VAC
 V_{out} : 100%
 I_{out} : 100%
 $T_a = 25^\circ\text{C}$

Z650-0.32

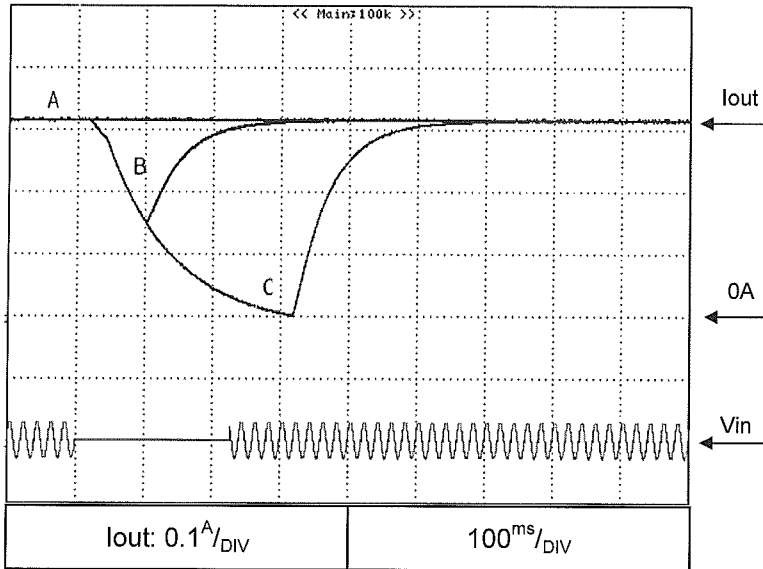

Brown-out time

A - 19mS

B - 45mS

C - 227mS

2.10 Inrush Current Characteristics during line brown outs

Conditions: Vin: 100VAC
Vout: 100%
Iout: 0%
Iout: 100%
Ta = 25°C

—————

Z160-1.3

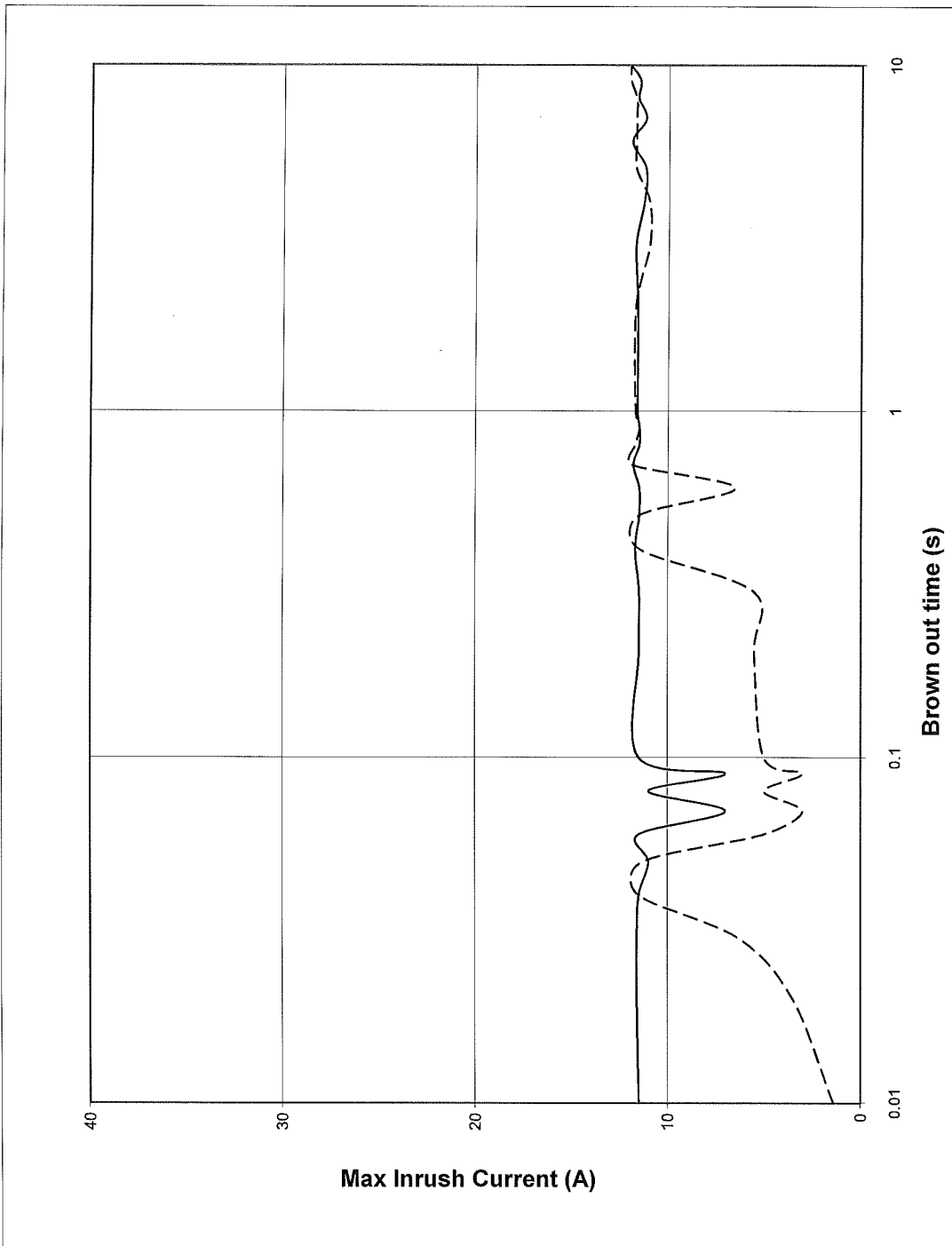

2.10 Inrush Current Characteristics during line brown outs

Conditions: Vin: 200VAC
Vout: 100%
Iout: 0% - - - - -
Iout: 100% - - - - -
Ta = 25°C

Z650-0.32

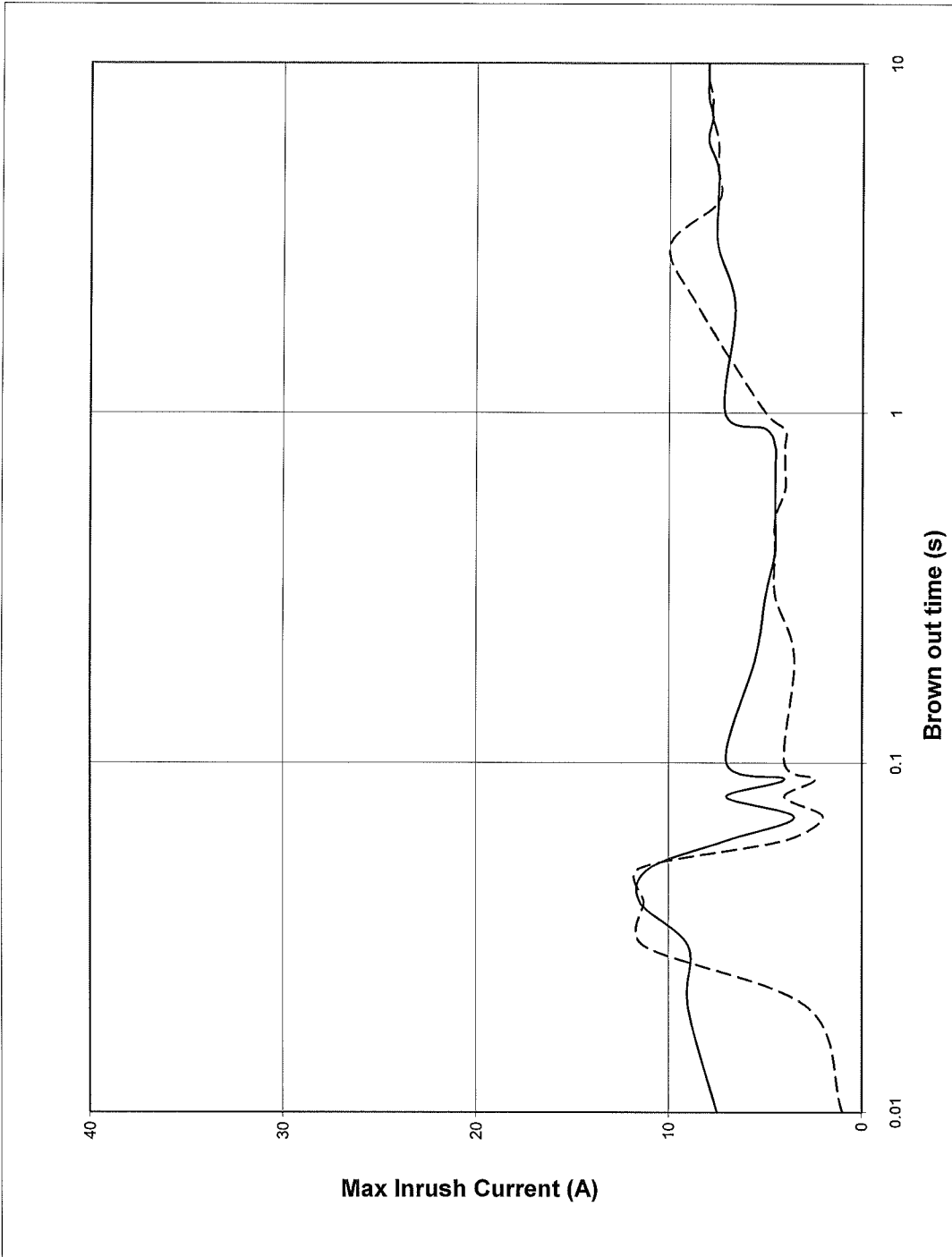

2.11 Inrush current waveform

Conditions: Vin: 100V
 Vout: 100%
 Iout: 100%
 Ta = 25°C

Z160-1.3

Switch on phase angle
 of input AC voltage
 $\phi=0^\circ$

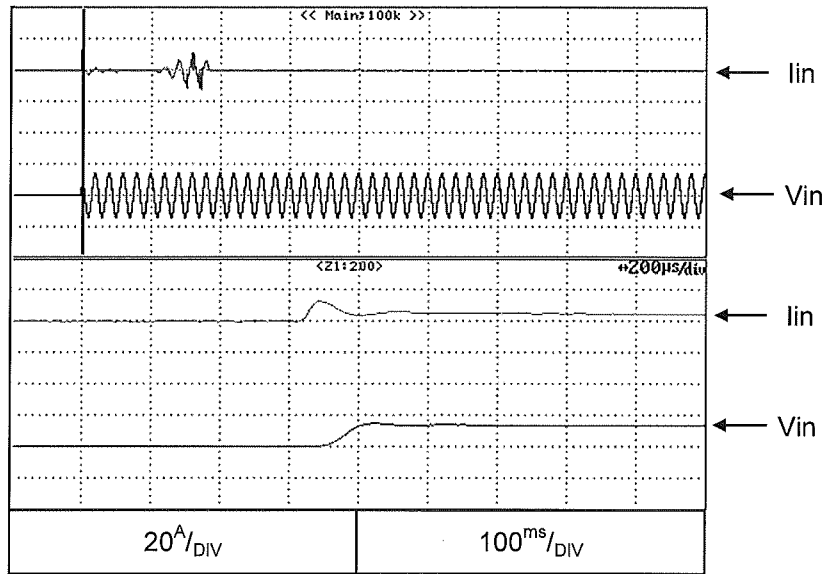

Switch on phase angle
 of input AC voltage
 $\phi=90^\circ$

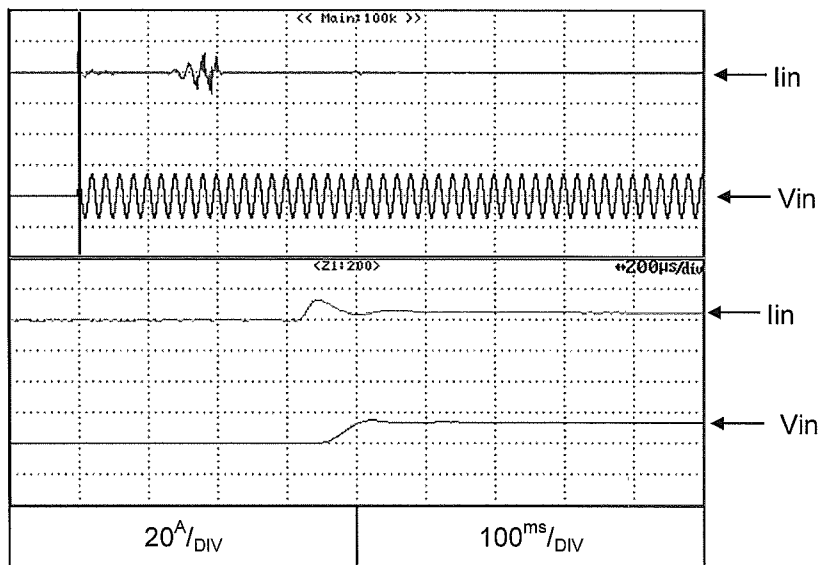

2.11 Inrush current waveform

Conditions: Vin: 200V
 Vout: 100%
 Iout: 100%
 Ta = 25°C

Z160-1.3

Switch on phase angle
 of input AC voltage

$\phi=0^\circ$

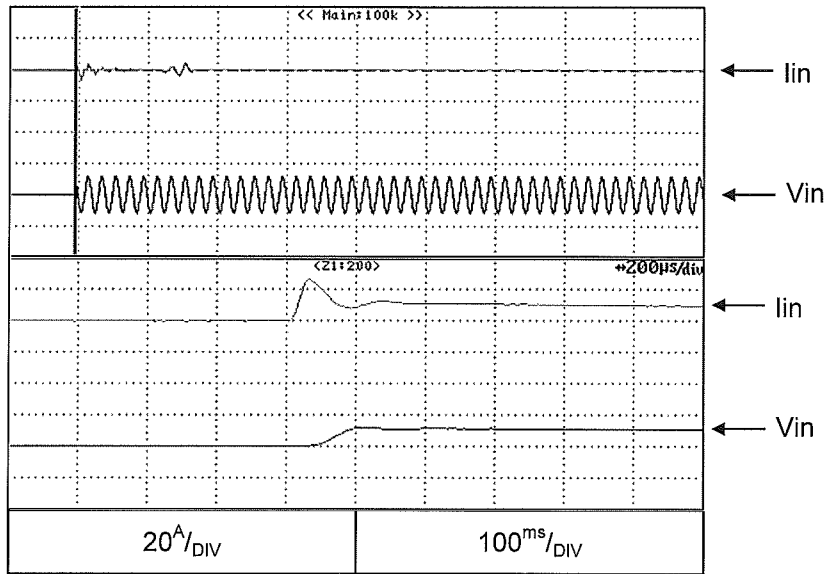

Switch on phase angle
 of input AC voltage

$\phi=90^\circ$

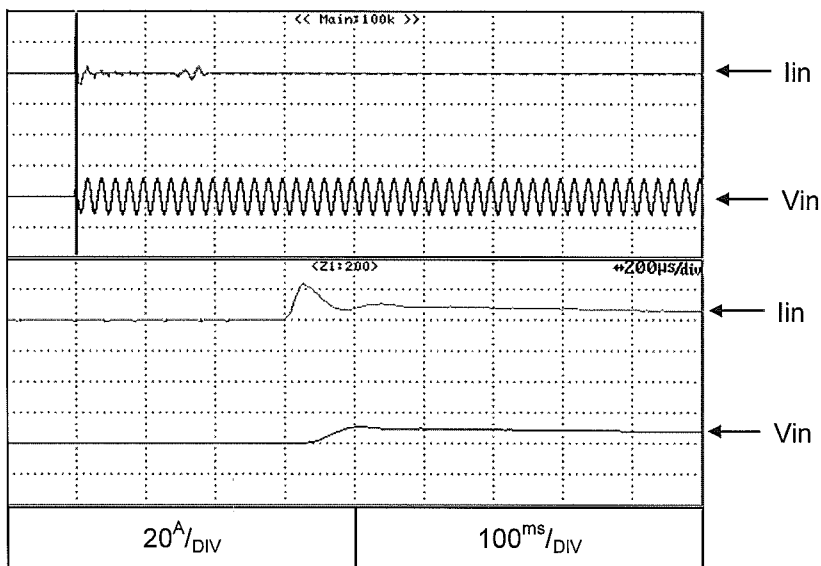

2.11 Inrush current waveform

Conditions: Vin: 100V
Vout: 100%
Iout: 100%
Ta = 25°C

Z650-0.32

Switch on phase angle
of input AC voltage

$\phi=0^\circ$

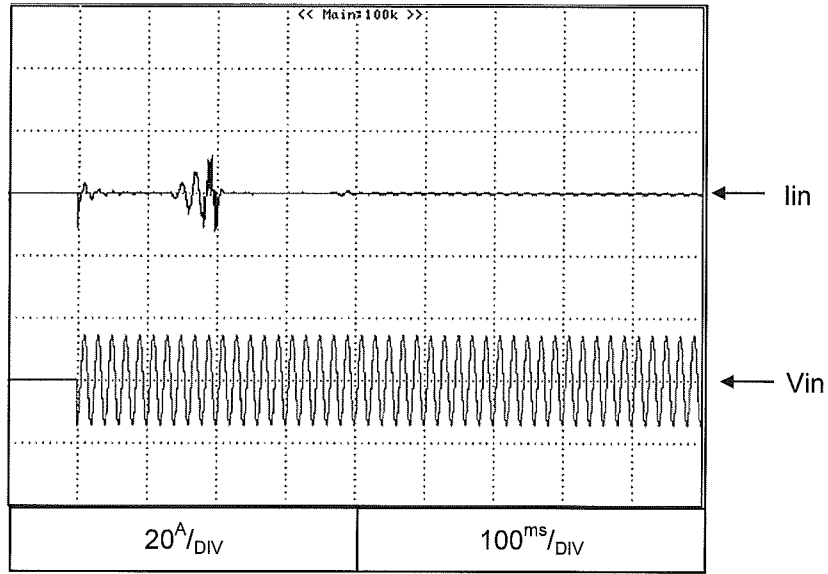

Switch on phase angle
of input AC voltage

$\phi=90^\circ$

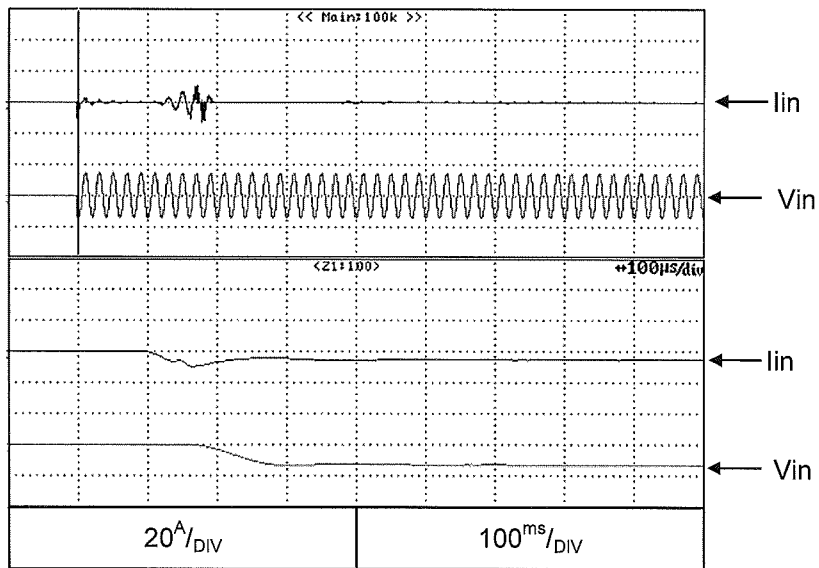

2.11 Inrush current waveform

Conditions: Vin: 200V
Vout: 100%
Iout: 100%
Ta = 25°C

Z650-0.32

Switch on phase angle
of input AC voltage

$\phi=0^\circ$

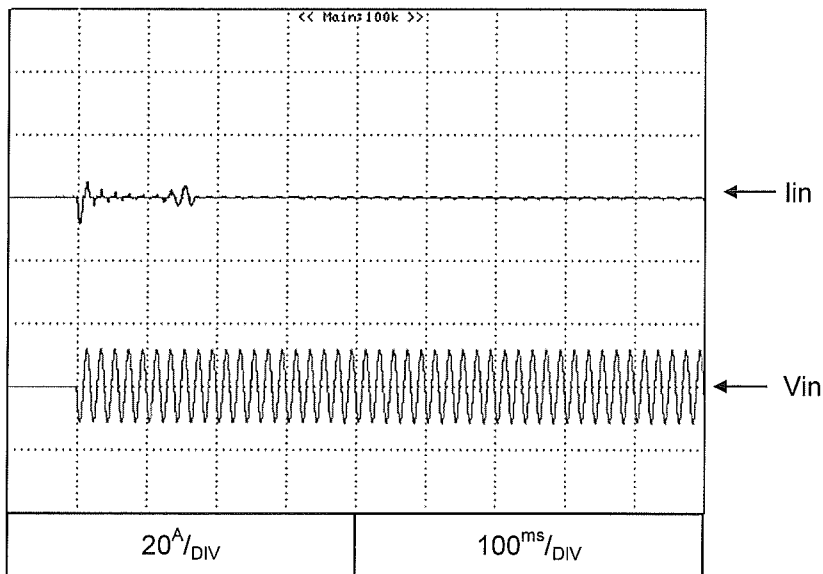

Switch on phase angle
of input AC voltage

$\phi=90^\circ$

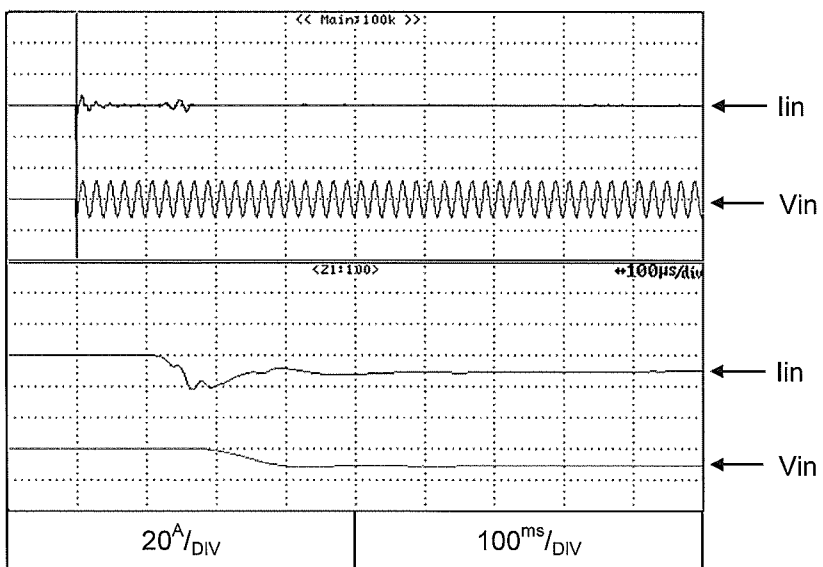

2.12 Input current waveform

Conditions: V_{in} : 100VAC
 V_{out} : 100%
 I_{out} : 100%
 $T_a = 25^\circ\text{C}$

Z160-1.3

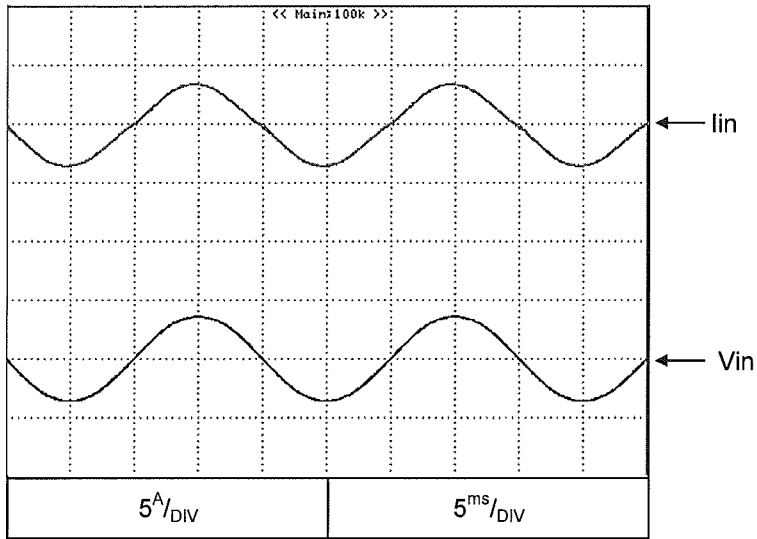

Conditions: V_{in} : 200VAC
 V_{out} : 100%
 I_{out} : 100%
 $T_a = 25^\circ\text{C}$

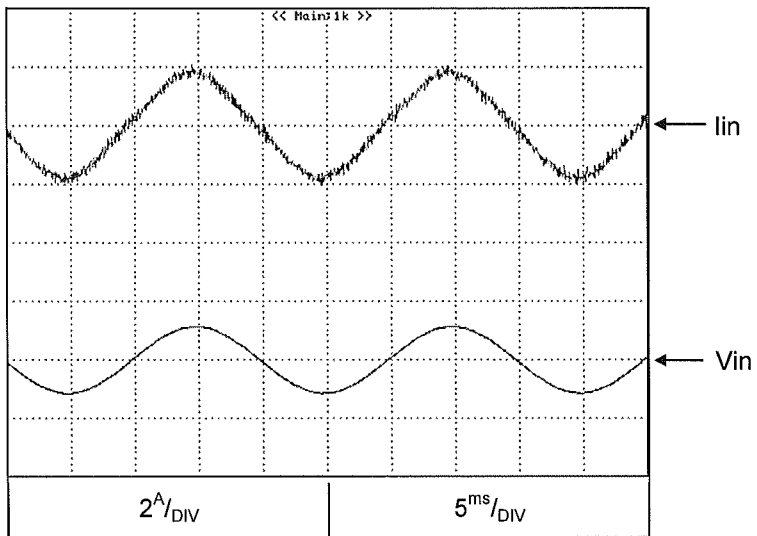

2.12 Input current waveform

Conditions: Vin: 100VAC
Vout: 100%
Iout: 100%
Ta = 25°C

Z650-0.32

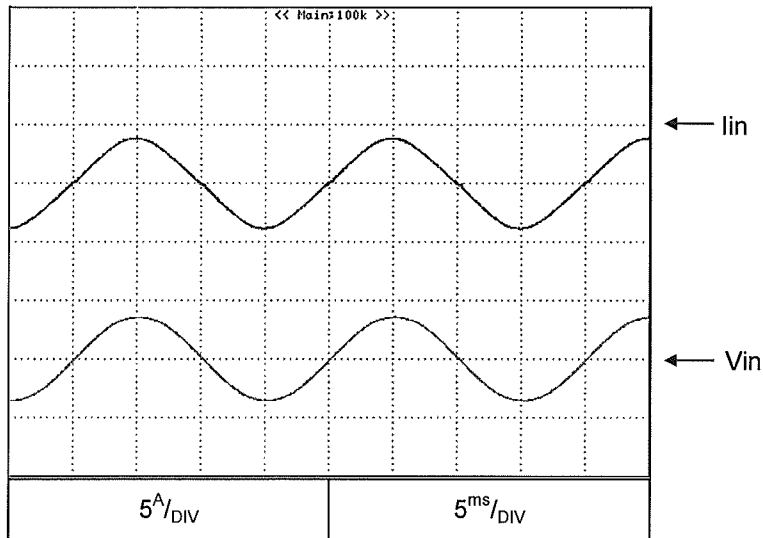

Conditions: Vin: 200VAC
Vout: 100%
Iout: 100%
Ta = 25°C

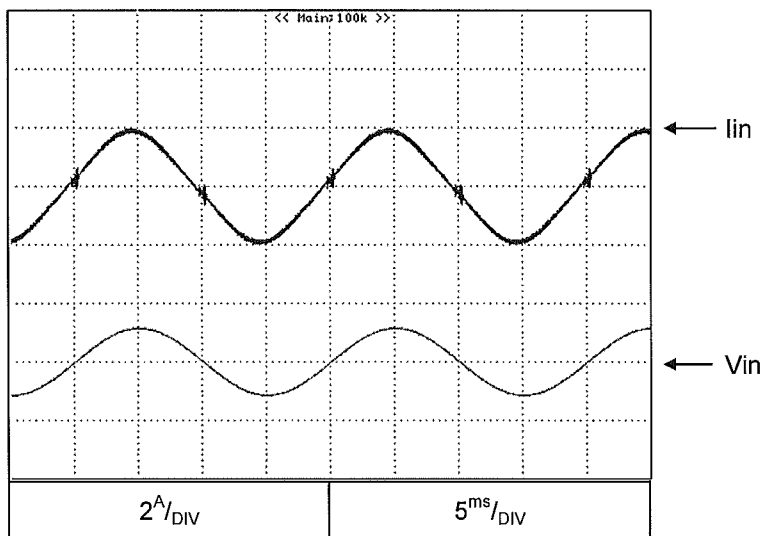

2.13 Leakage current characteristics

Conditions: Vin: 100~265Vac

Iout: 0% - - - - -

Iout: 100% ————

Ta = 25°C

f=50HZ

Z650-0.32

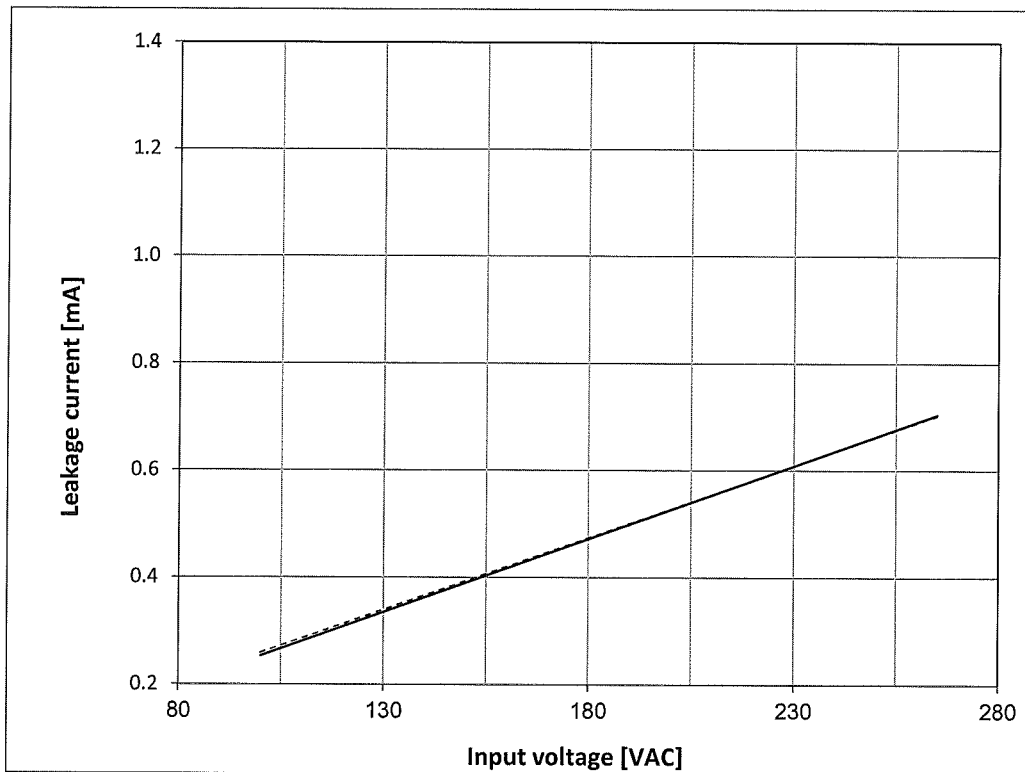

2.14 Output voltage ripple & noise waveform

Conditions: V_{in} : 100VAC
 V_{out} : 100%
 I_{out} : 100%
 $T_a = 25^\circ\text{C}$

C.V mode

Normal Mode

Z160-1.3

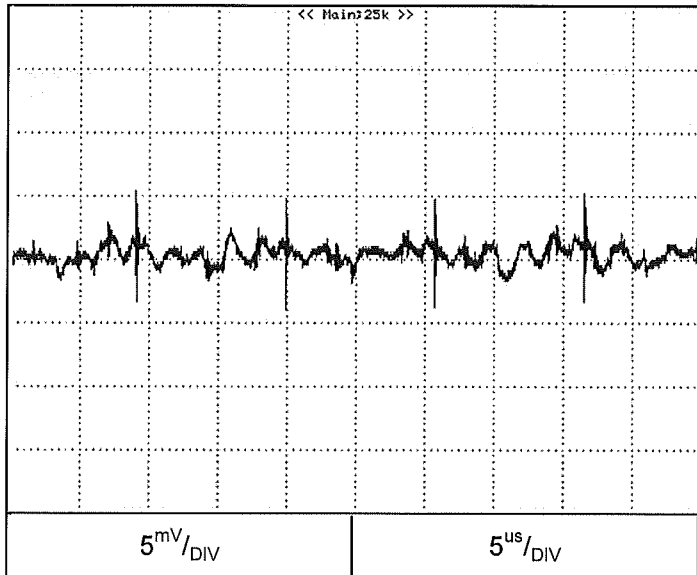

Z650-0.32

