



Z⁺600 Series

EVALUATION

DATA

DWG No.: IA712-53-01		
APPD	CHK	DWG
 20/3/13	 20/3/13	Yanni 10/03/13

INDEX

PAGE

1. EVALUATION METHOD

1.1 Circuit used for determination	T-1~4
(1) Steady state data	
(2) Warm up voltage drift characteristic	
(3) Warm up current drift characteristic	
(4) Over voltage protection (OVP) characteristics	
(5) Output voltage rise/fall characteristics	
(6) Output current rise/fall characteristics	
(7) Dynamic line voltage and current response characteristic	
(8) Dynamic load voltage and current response characteristics	
(9) Response to brown-out characteristic	
(10) Inrush current characteristics	
(11) Leakage current characteristics	
(12) Output Voltage ripple & noise waveform 10V to 100V models	
(13) Output Current ripple & noise waveform 10V to 100V models	
1.2 List of equipment used	T-5

2. CHARACTERISTICS

2.1 Steady state data	
(1) Regulation - Line & Load, Temperature drift	T-6~11
(2) Output voltage and ripple voltage v.s input voltage	T-12~14
(3) Output current and ripple current v.s input voltage	
(4) Efficiency and Input current vs. Output current	T-15~17
2.2 Warm up voltage drift & temperature stability	T-18~20
2.3 Over voltage protection (OVP) characteristic	T-21~22
2.4 ON/OFF Output rise characteristics	T-23~30
2.5 ON/OFF Output fall characteristics	T-31~38
2.6 Hold up time characteristic	T-39~41
2.7 Dynamic line response characteristics	T-42~47
2.8 Dynamic load response characteristics	T-48~52
2.9 Response to brown-out characteristic	T-53~58
2.10 Inrush current characteristic	T-59~60
2.11 Inrush current waveform	T-61~64
2.12 Input current waveform	T-65~66
2.13 Leakage current characteristic	T-67
2.14 Output voltage ripple & noise waveform	T-68~69

TERMINOLOGY USED

Definition

Vin	Input voltage
Vout	Output voltage
Iin	Input current
Iout	Output current
Ta	Ambient temperature
f	Frequency
C.V	Constant voltage mode
C.C	Constant current mode

1. EVALUATION METHOD

1.1 Circuit used for determination

(1) Steady state data

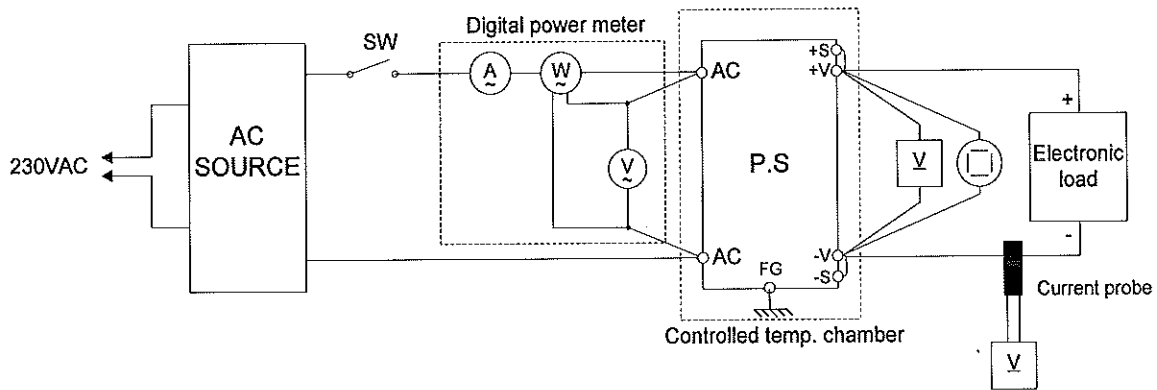

(2) Warm up voltage drift characteristic same as Steady state data

(3) Warm up current drift characteristic same as Steady state data

(4) Over voltage protection (OVP) characteristics

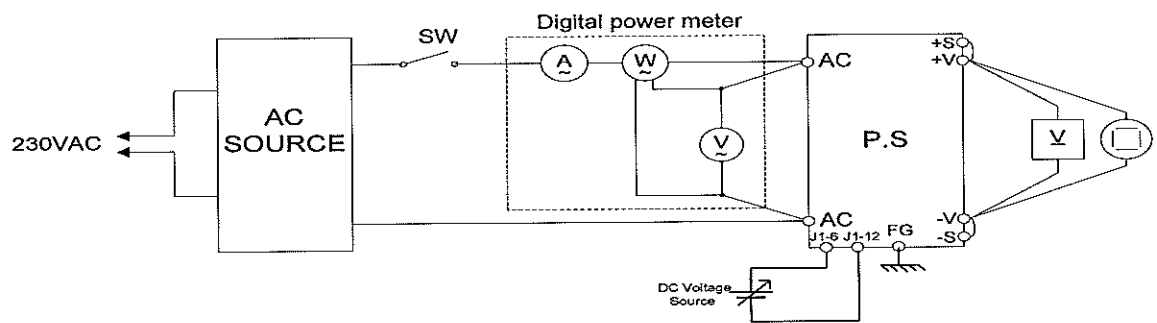

(5) Output voltage rise/fall characteristics same as Steady state data

(6) Output current rise/fall characteristics

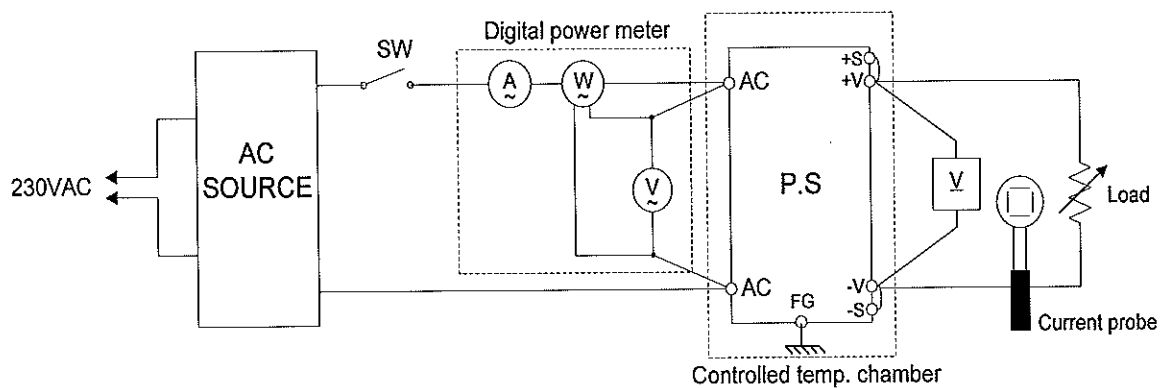

1.1 Circuit used for determination

(7) Dynamic line voltage and current response characteristics

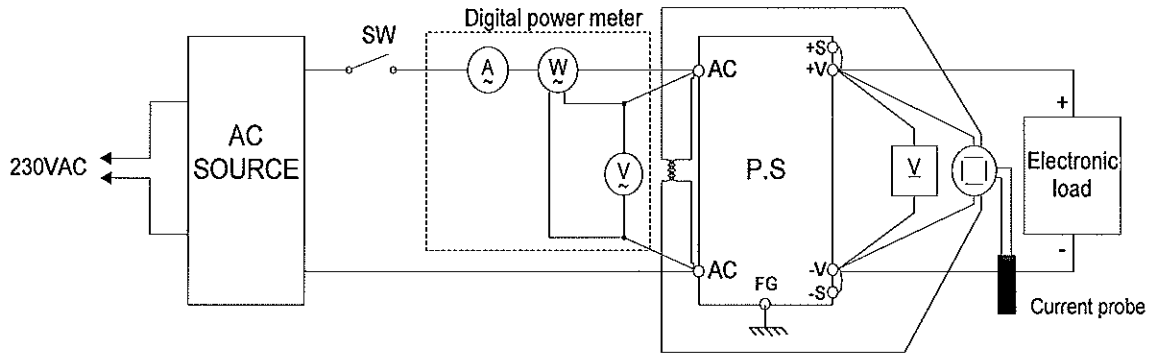

(8) Dynamic load voltage and current response characteristics

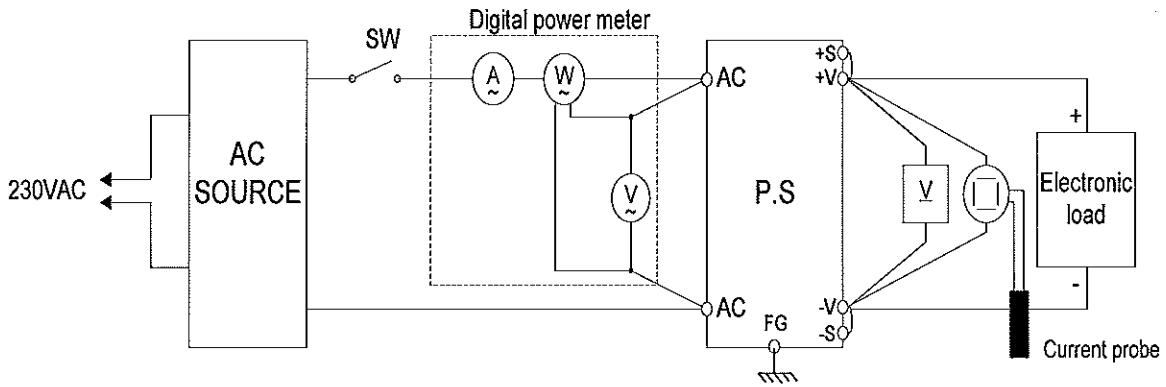

Constant Voltage mode

Output current waveform
Iout 0% <---> 100%

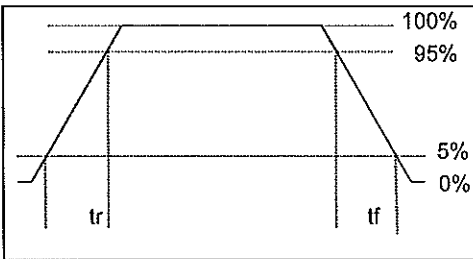

Output current waveform
Iout 50% <---> 100%

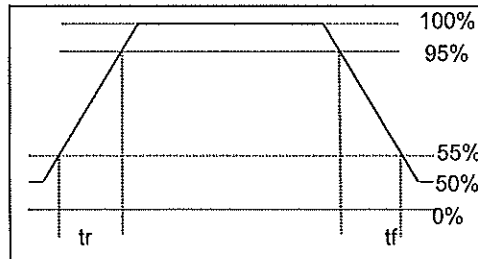

1.1 Circuit used for determination

(9) Response to brown-out characteristic

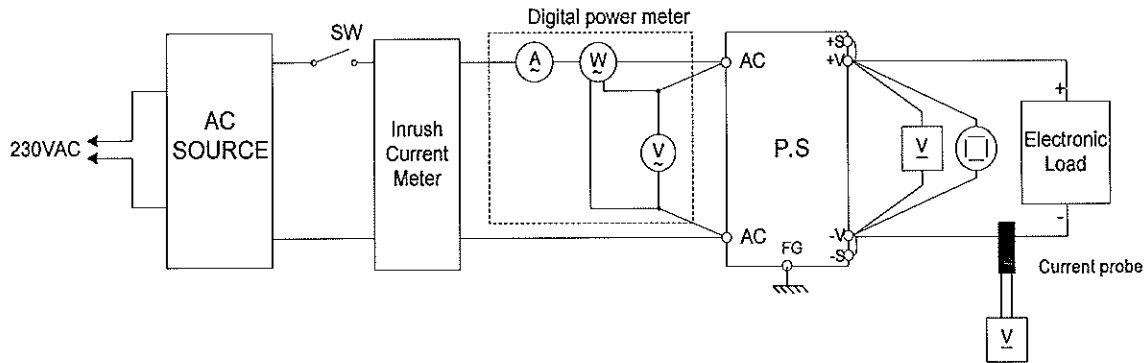

(10) Inrush current characteristics same as Response to brown-out

(11) Leakage current characteristics

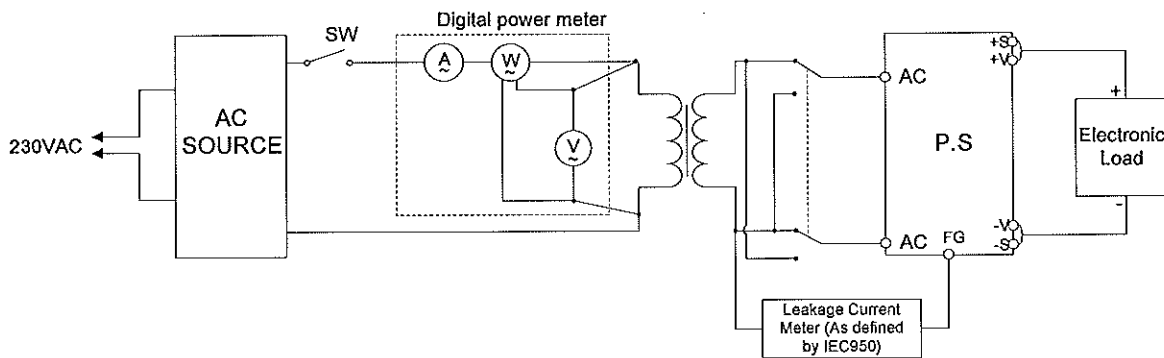

(12) Output Voltage ripple & noise waveform 10V up to 100V models

(a) Normal mode (JEITA Standard RC-9131A)

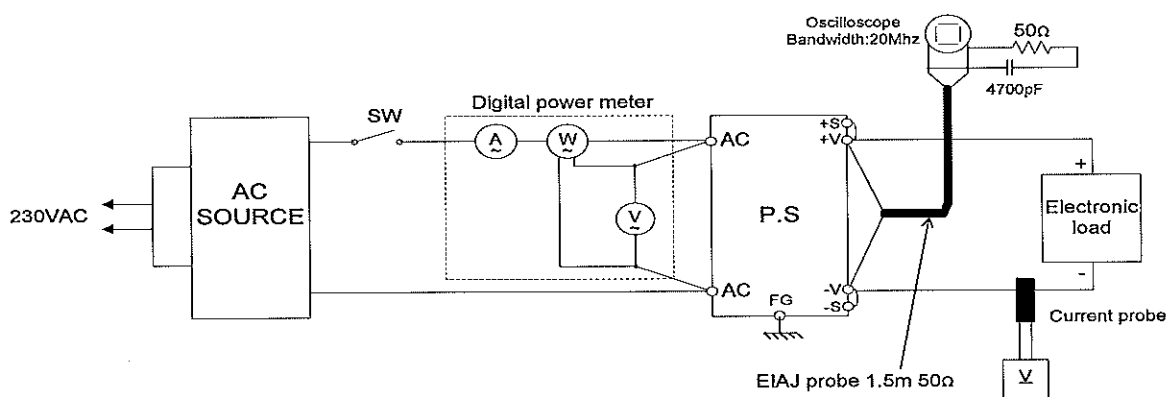

1.1 Circuit used for determination

(12) Output Voltage ripple & noise waveform 10V up to 100V models

(b) Normal + Common mode

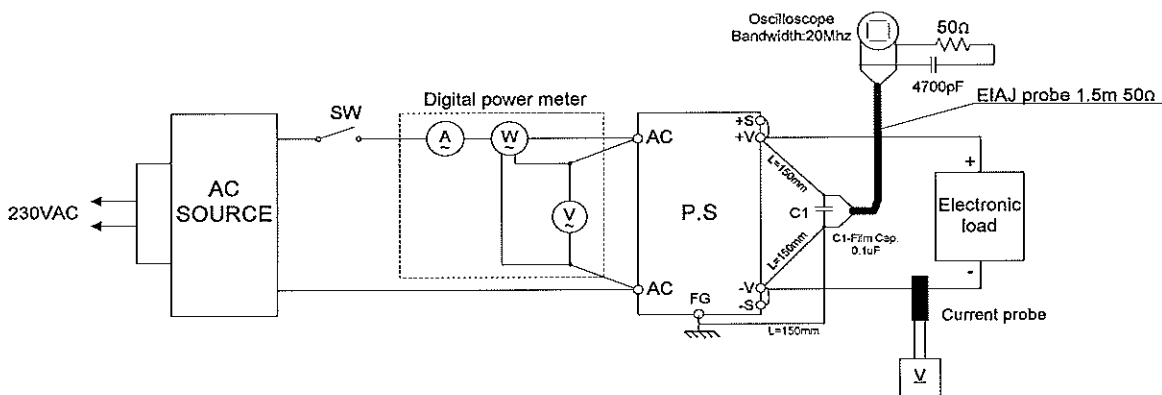

(13) Output Current rms ripple 10V to 100V models

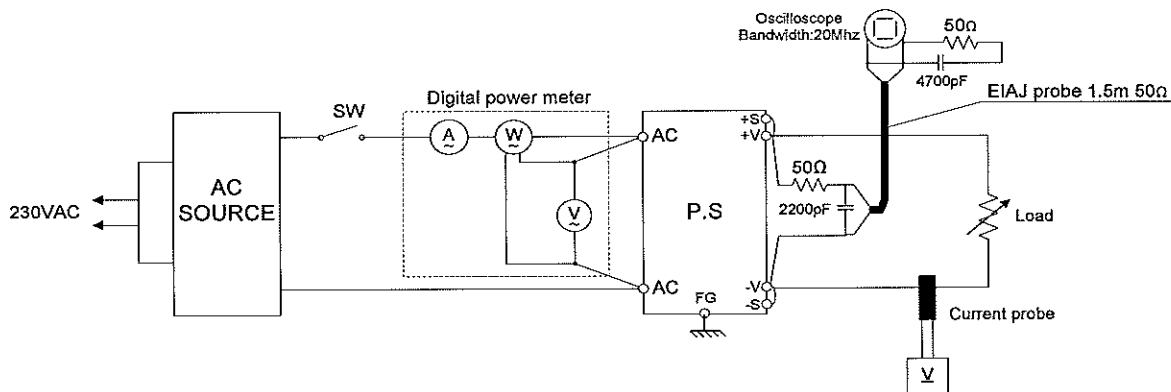

Notes:

(*) Output Current rms ripple = Output Voltage rms ripple divided by the Load resistance.

1.2 List of equipment used

	EQUIPMENT USED	MANUFACTURER	MODEL No.
1	Digital oscilloscope	YOKOGAWA	DL7100
2	Digital oscilloscope	YOKOGAWA	DL1740EL
3	Digital multimeter	AGILENT	34401A
4	Digital power meter	YOKOGAWA	WT230
5	AC Source	CHROMA	6590
6	AC Source	CHROMA	6530
7	Electronic load	H&H	ZS6060 SC150
8	Electronic load	H&H	ZS7006
9	Electronic load	H&H	ZS7060
10	Electronic load	CHROMA	63203
11	Electronic load	CHROMA	63204
12	Electronic load	CHROMA	63206
13	Controlled temp. chamber	THERMOTRON	SM-16-3800
14	Controlled temp. chamber	THERMOTRON	SE-600-5-5
15	Controlled temp. chamber	THERMOTRON	SE-600-6-6
16	Leakage Current Tester	KIKUSUI	TOS3200
17	Voltage probe	YOKOGAWA	700988
18	Current probe	YOKOGAWA	701933
19	Current probe	LEM Danfysik	IT 60-S Ultrastab
20	Inrush Current Meter	TAKAMISAWA	PSA-210
21	Data Acquisition/Switch Unit	AGILENT	34970A

2. CHARACTERISTIC

2.1 Steady state data

(1) Regulation - Line & Load, Temperature drift

Z10-60

Conditions: Ta = 25°C

1. Regulation - Line & Load, C.V mode (Readings in [V])

Io	Vin (AC)				Line Regulation	
	85	100	200	265		
0%	9.9999	9.9999	9.9999	9.9999	0.0	0.000
25%	9.9996	9.9996	9.9996	9.9996	0.0	0.000
50%	9.9992	9.9992	9.9992	9.9992	0.0	0.000
75%	9.9989	9.9989	9.9989	9.9989	0.0	0.000
100%	9.9986	9.9986	9.9986	9.9986	0.0	0.000
Load Regulation	1.3	1.3	1.3	1.3	$\Delta V(mV)$	(%)
	0.013	0.013	0.013	0.013	(%)	

2. Temperature drift, C.V mode

Conditions: Vin:100Vac
Iout:100%

Ta	0°C	25°C	50°C	Temp. Coefficient (0°C~50°C)	
Vout	9.999	9.999	9.998	1 mV	2 ppm/°C

2.1 Steady state data

(1) Regulation - Line & Load, Temperature drift

Z36-18

Conditions: Ta = 25°C

1. Regulation - Line & Load, C.V mode (Readings in [V])

Io	Vin (AC)				Line Regulation	
	85	100	200	265		
0%	36.0007	36.0008	36.0007	36.0006	0.2	0.001
25%	36.0004	36.0003	36.0003	36.0004	0.1	0.000
50%	36.0001	36.0000	36.0001	36.0001	0.1	0.000
75%	35.9999	36.0000	35.9999	35.9998	0.2	0.001
100%	35.9998	35.9997	35.9998	35.9998	0.1	0.000
Load Regulation	0.9	1.1	0.9	0.8	$\Delta V(mV)$	(%)
	0.002	0.003	0.002	0.002	(%)	

2. Temperature drift, C.V mode

Conditions: Vin:100Vac
Iout:100%

Ta	0°C	25°C	50°C	Temp. Coefficient (0°C~50°C)	
Vout	36.001	35.992	35.986	15 mV	9 ppm/°C

2.1 Steady state data

(1) Regulation - Line & Load, Temperature drift

Z100-6

Conditions: $T_a = 25^\circ\text{C}$

1. Regulation - Line & Load, C.V mode (Readings in [V])

Io	Vin (AC)				Line Regulation	
	85	100	200	265	$\Delta V(\text{mV})$	(%)
0%	99.9993	99.9993	99.9991	99.9991	0.2	0.000
25%	99.9989	99.9989	99.9988	99.9987	0.2	0.000
50%	99.9985	99.9985	99.9985	99.9984	0.1	0.000
75%	99.9984	99.9983	99.9984	99.9984	0.1	0.000
100%	99.9983	99.9983	99.9982	99.9982	0.1	0.000
Load Regulation	1.0	1.0	0.9	0.9	$\Delta V(\text{mV})$	(%)
	0.001	0.001	0.001	0.001	(%)	

2. Temperature drift, C.V mode

Conditions: $V_{in}: 100\text{Vac}$
 $I_{out}: 100\%$

T_a	0°C	25°C	50°C	Temp. Coefficient ($0^\circ\text{C}\sim 50^\circ\text{C}$)	
V_{out}	100.012	99.983	99.964	48 mV	10 ppm/ $^\circ\text{C}$

2.1 Steady state data

(1) Regulation - Line & Load, Temperature drift

Z10-60

Conditions: Ta = 25°C

1. Regulation - Line & Load, C.C mode (*) (Readings in [A])

Vo	Vin (AC)				Line Regulation	
	85	100	200	265		
0%	59.9396	59.9396	59.9396	59.9396	0.0	0.000
25%	59.9389	59.9389	59.9389	59.9389	0.0	0.000
50%	59.9383	59.9383	59.9383	59.9383	0.0	0.000
75%	59.9378	59.9378	59.9378	59.9378	0.0	0.000
100%	59.9375	59.9375	59.9375	59.9375	0.0	0.000
Load	2.1	2.1	2.1	2.1	$\Delta I(mA)$	(%)
Regulation	0.004	0.004	0.004	0.004	(%)	

Notes:

(*) Not including load regulation thermal drift effect.

2. Temperature drift, C.C mode

Conditions: Vin:100Vac
Iout:100%

Ta	0°C	25°C	50°C	Temp. Coefficient (0°C~50°C)	
Iout	59.9865	59.9415	59.9066	79.8 mA	27 ppm/°C

2.1 Steady state data

(1) Regulation - Line & Load, Temperature drift

Z36-18

Conditions: Ta = 25°C

1. Regulation - Line & Load, C.C mode (*) (Readings in [A])

Vo	Vin (AC)				Line Regulation	
	85	100	200	265		
0%	17.9967	17.9965	17.9965	17.9965	0.2	0.001
25%	17.9966	17.9964	17.9961	17.9961	0.5	0.003
50%	17.9957	17.9955	17.9954	17.9953	0.4	0.002
75%	17.9951	17.9951	17.9951	17.9952	0.1	0.001
100%	17.9950	17.9951	17.9951	17.9951	0.1	0.001
Load Regulation	1.7	1.4	1.4	1.4	ΔI (mA)	(%)
	0.009	0.008	0.008	0.008	(%)	

Notes:

(*) Not including load regulation thermal drift effect.

2. Temperature drift, C.C mode

Conditions: Vin:100Vac
Iout:100%

Ta	0°C	25°C	50°C	Temp. Coefficient (0°C~50°C)	
Iout	18.0012	17.9826	17.9687	32.5 mA	36 ppm/°C

2.1 Steady state data

(1) Regulation - Line & Load, Temperature drift

Z100-6

Conditions: Ta = 25°C

1. Regulation - Line & Load, C.C mode (*) (Readings in [A])

Vo	Vin (AC)				Line Regulation	
	85	100	200	265		
0%	6.0005	6.0005	6.0005	6.0005	0.0	0.000
25%	6.0002	6.0002	6.0002	6.0002	0.0	0.000
50%	5.9999	5.9999	5.9999	5.9999	0.0	0.000
75%	5.9997	5.9997	5.9997	5.9997	0.0	0.000
100%	5.9994	5.9994	5.9993	5.9993	0.1	0.002
Load Regulation	1.1	1.1	1.2	1.2	ΔI (mA)	(%)
	0.018	0.018	0.020	0.020	(%)	

Notes:

(*) Not including load regulation thermal drift effect.

2. Temperature drift, C.C mode

Conditions: Vin:100Vac
Iout:100%

Ta	0°C	25°C	50°C	Temp. Coefficient (0°C~50°C)	
Iout	6.0013	5.9981	5.9991	3.2 mA	11 ppm/°C

2.1 Steady state data

(2) Output voltage and ripple voltage v.s input voltage

C.V mode

Conditions: Iout:100%

Z10-60

Ta: 0°C -----
 25°C -----
 50°C -----

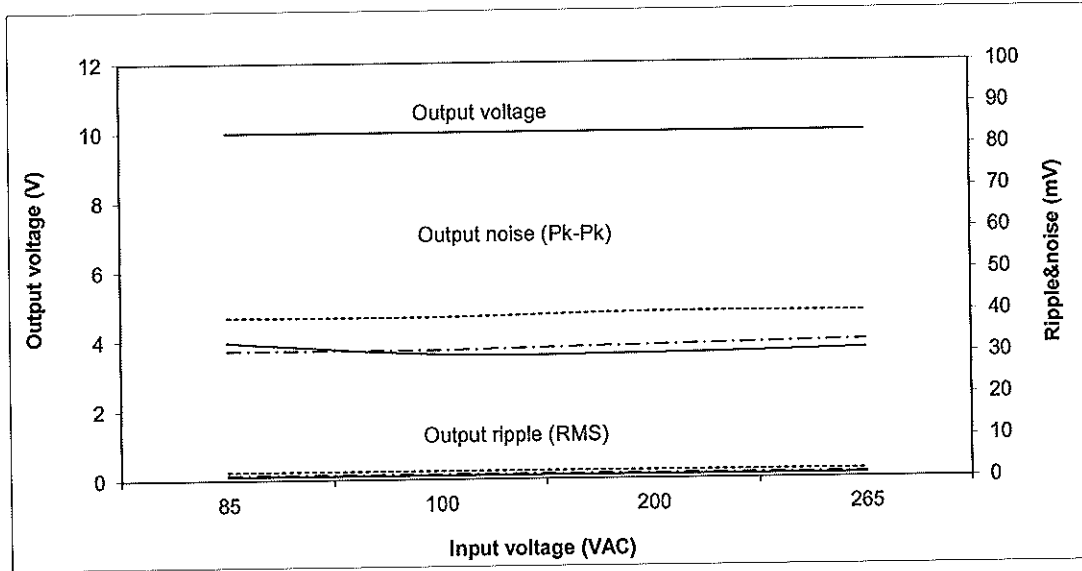

(3) Output current and ripple current v.s input voltage

C.C mode

Conditions: Vout:100%

Z10-60

Ta: 0°C -----
 25°C -----
 50°C -----

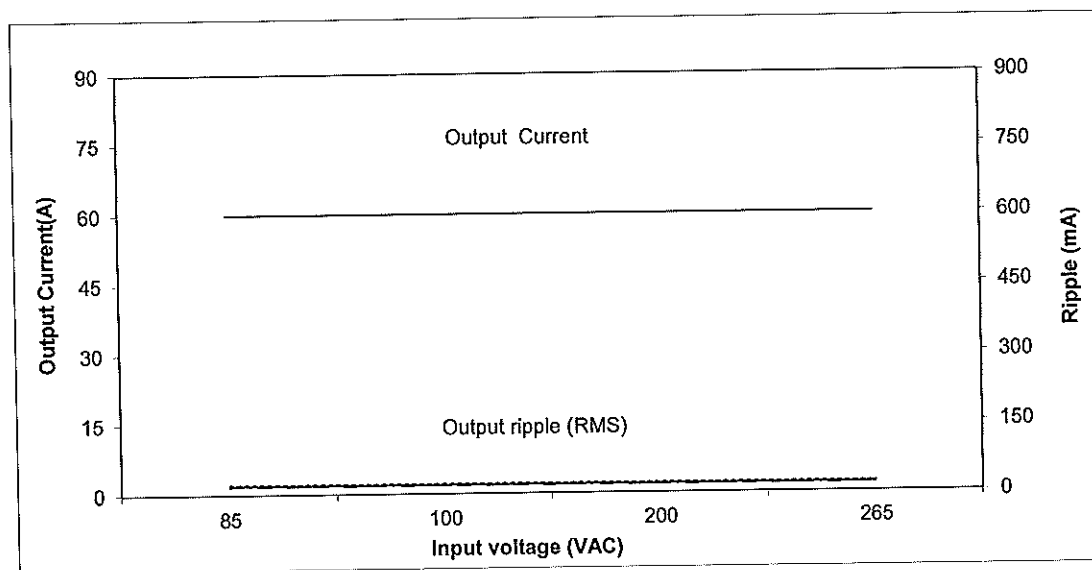

2.1 Steady state data

(2) Output voltage and ripple voltage v.s input voltage

C.V mode

Conditions: Iout:100%

Z36-18

Ta: 0°C -----
 25°C -----
 50°C -----

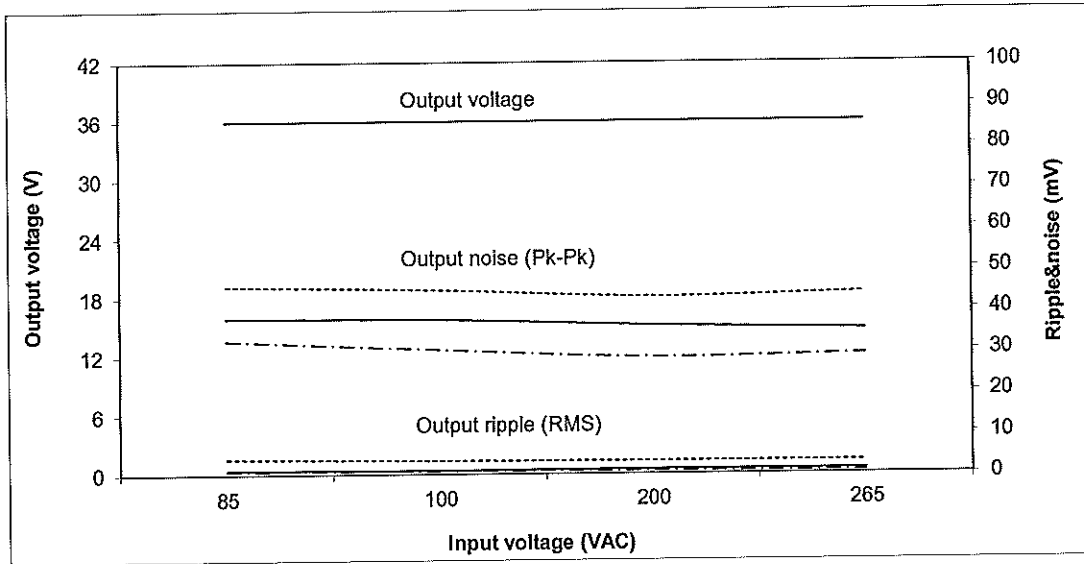

(3) Output current and ripple current v.s input voltage

C.C mode

Conditions: Vout:100%

Z36-18

Ta: 0°C -----
 25°C -----
 50°C -----

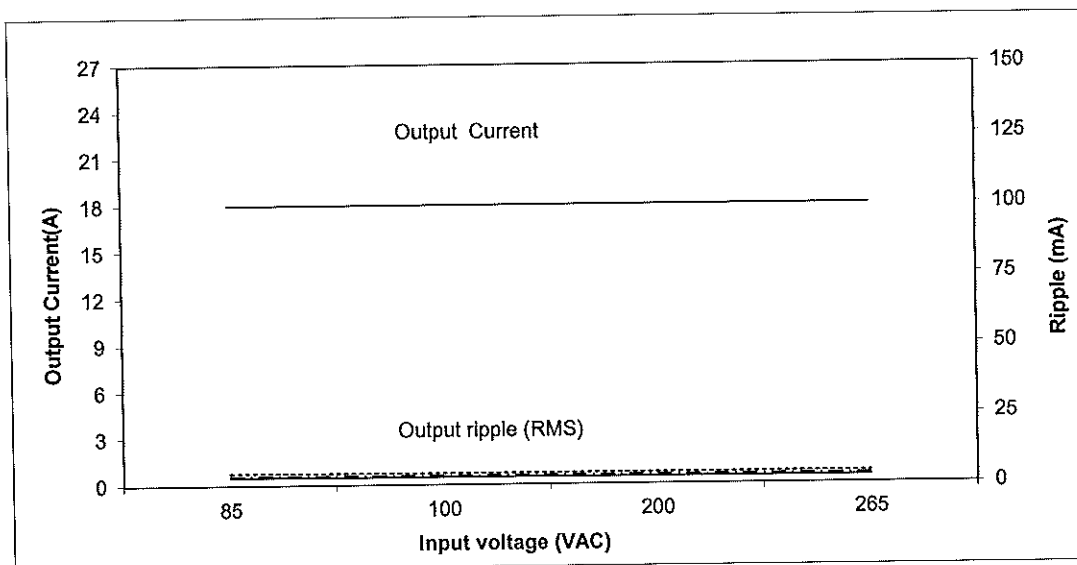

2.1 Steady state data

(2) Output voltage and ripple voltage v.s input voltage

C.V mode

Conditions: Iout:100%

Z100-6

Ta: 0°C -----
 25°C -----
 50°C -----

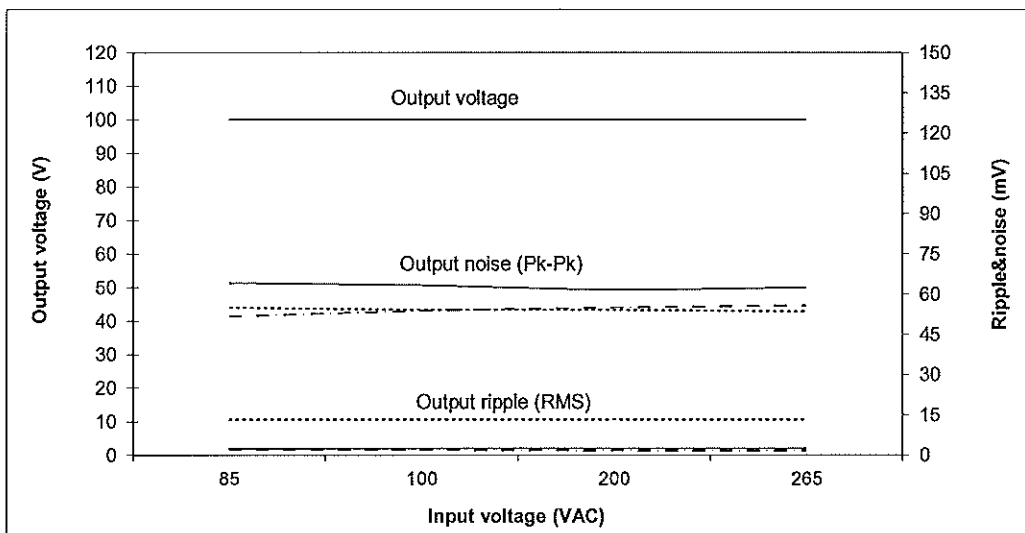

(3) Output current and ripple current v.s input voltage

C.C mode

Conditions: Vout:100%

Z100-6

Ta: 0°C -----
 25°C -----
 50°C -----

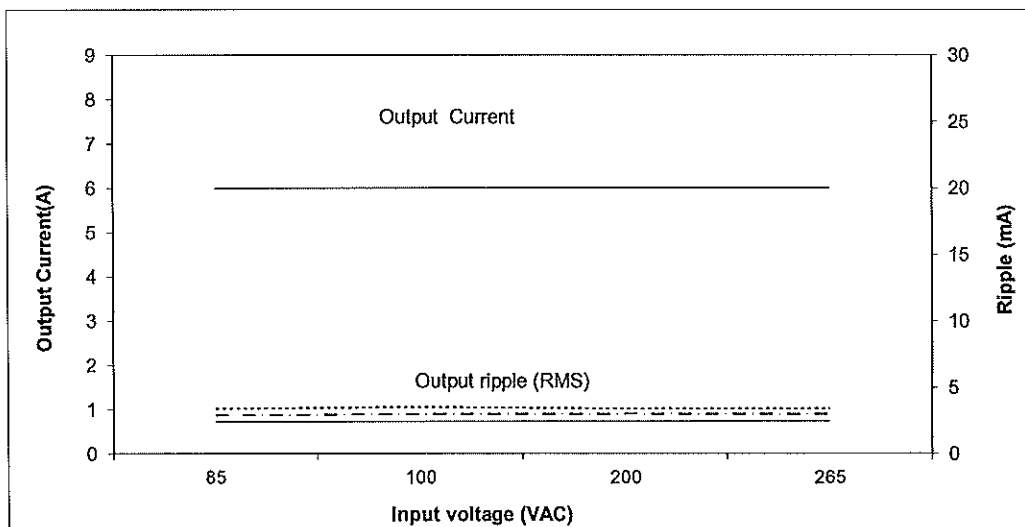

2.1 Steady state data

(4) Efficiency and Input current vs. Output current

Conditions:

- Vin: 85 VAC -----
- 100VAC -----
- 200 VAC -----
- 265 VAC -----
- Vout:100%
- Ta: 25°C

Z10-60

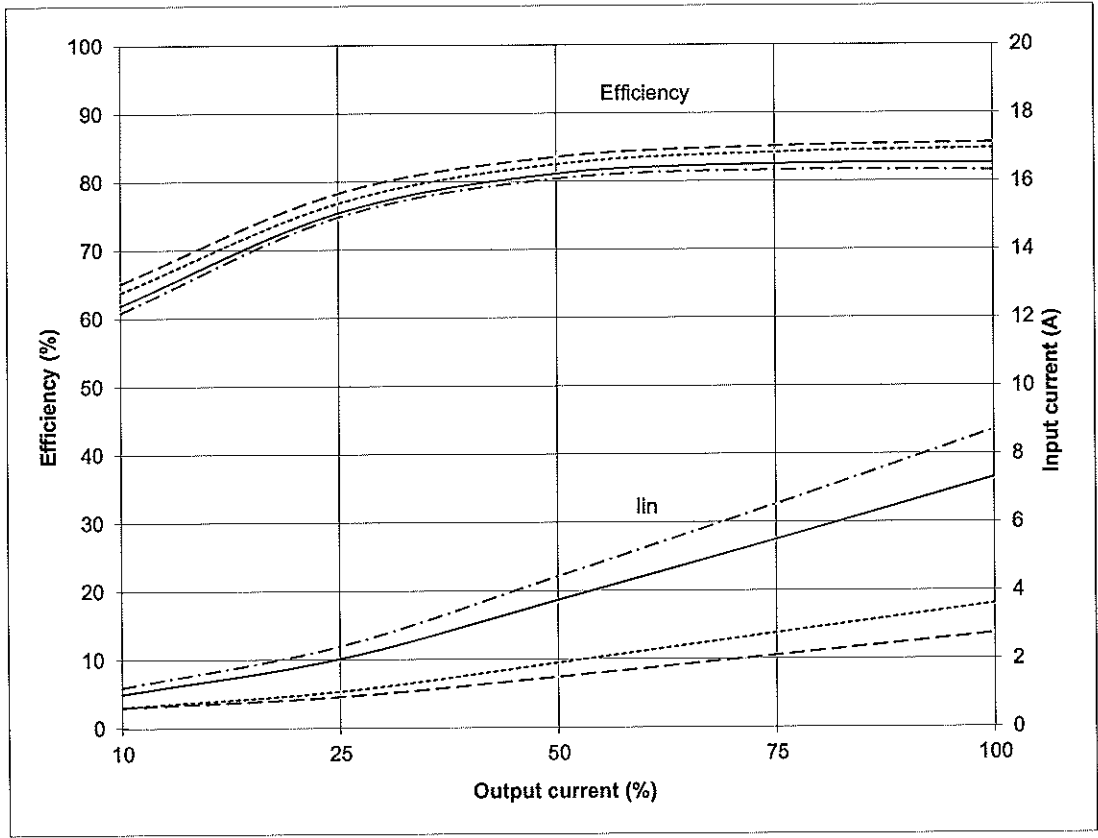

2.1 Steady state data

(4) Efficiency and Input current vs. Output current

Conditions:

- Vin: 85 VAC -----
- 100VAC -----
- 200 VAC -----
- 265 VAC -----
- Vout:100%
- Ta: 25°C

Z36-18

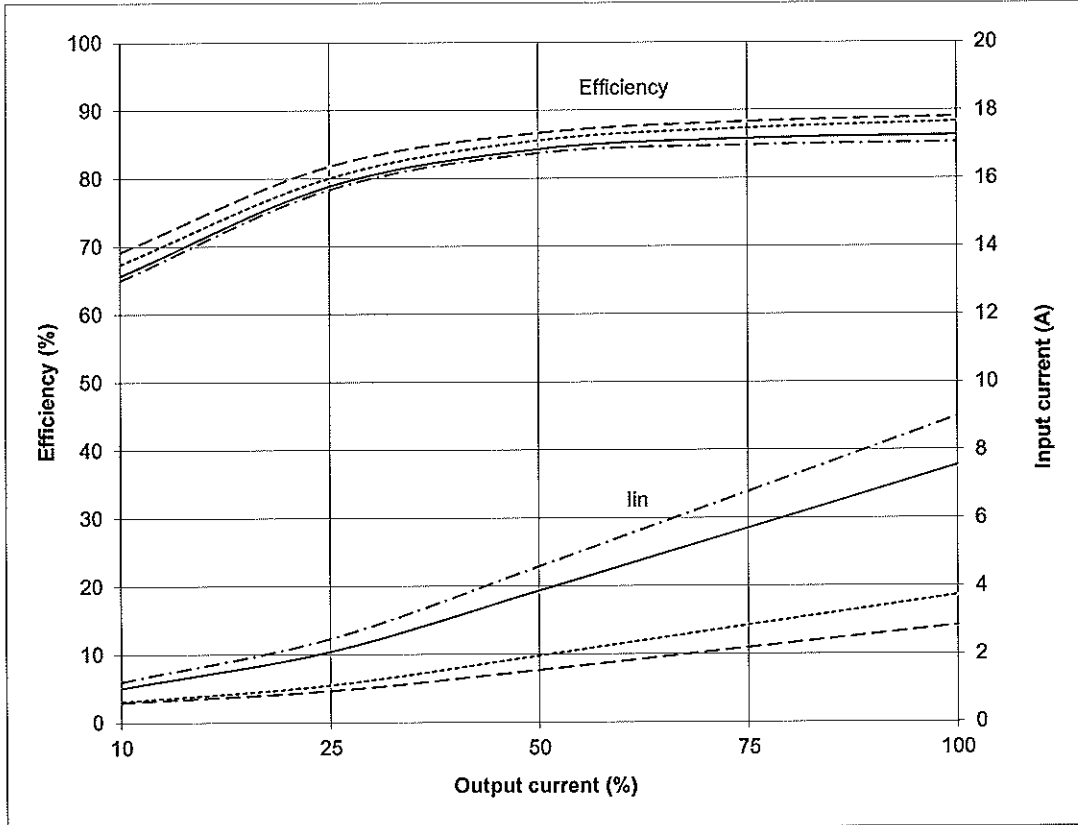

2.1 Steady state data

(4) Efficiency and Input current vs. Output current

Conditions:

- Vin: 85 VAC -----
- 100VAC -----
- 200 VAC -----
- 265 VAC -----
- Vout:100%
- Ta: 25°C

Z100-6

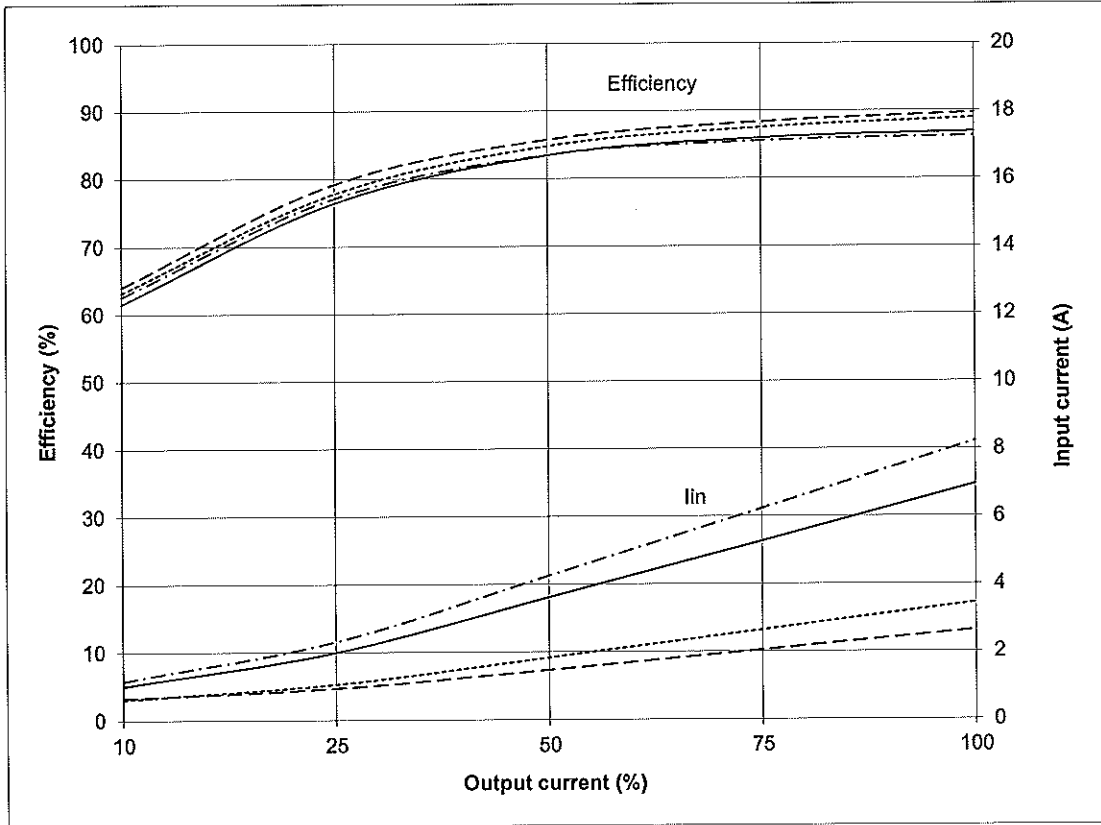

2.2 Warm up drift & stability

Conditions: Vin:100Vac
Vout: 100%
Iout: 100%
Ta = 25°C

C.V mode

Z10-60

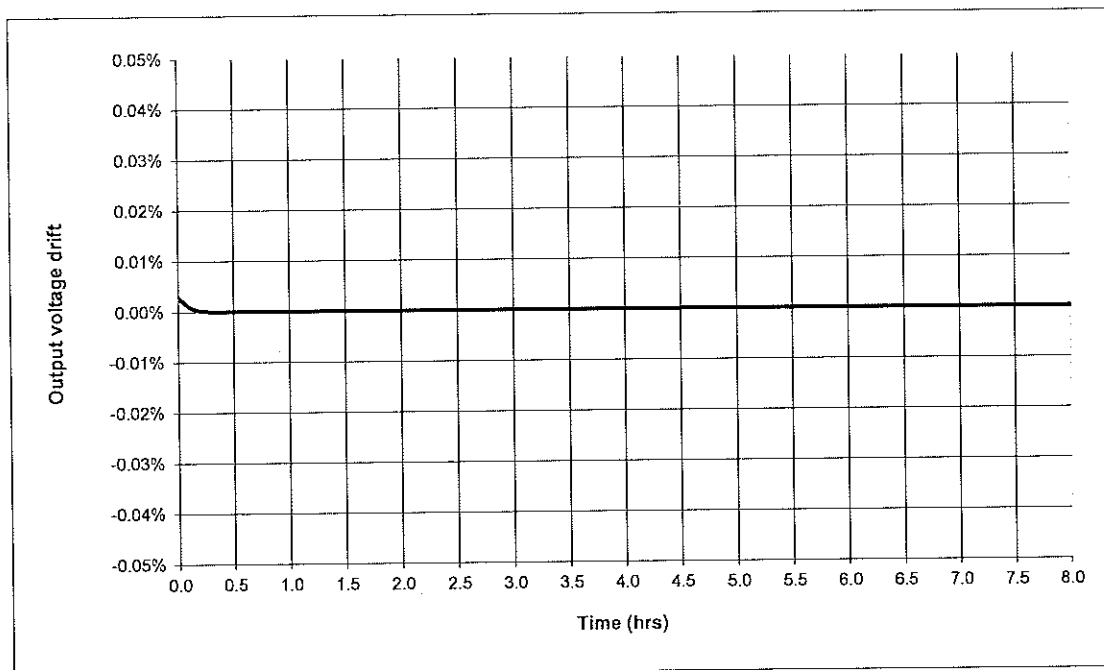

C.C mode

Z10-60

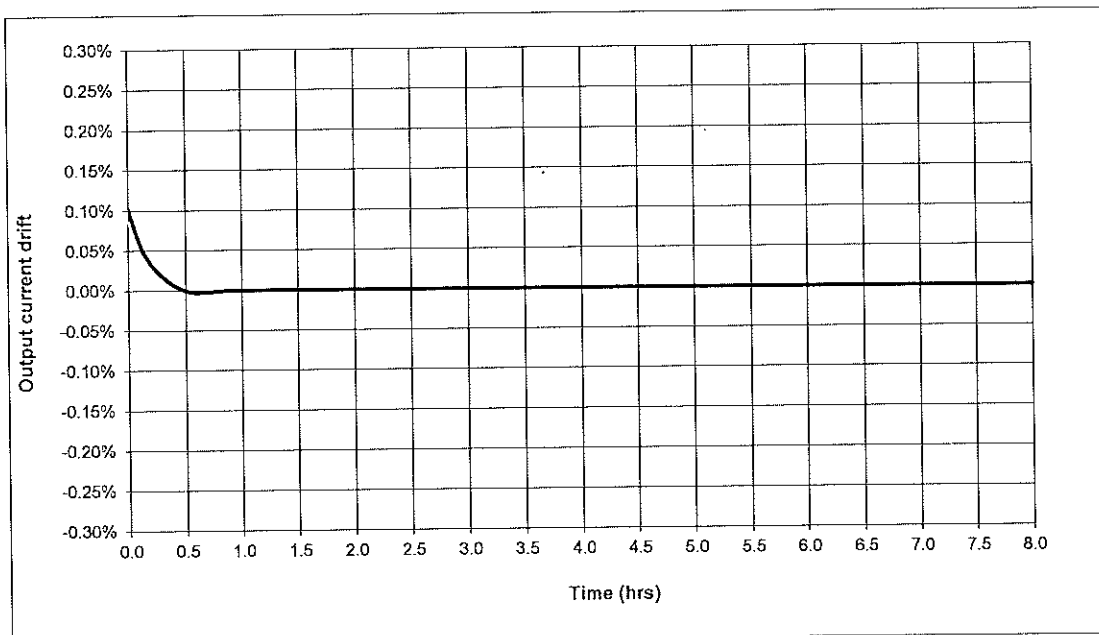

2.2 Warm up drift & stability

Conditions: Vin:100Vac
Vout: 100%
Iout: 100%
Ta = 25°C

C.V mode

Z36-18

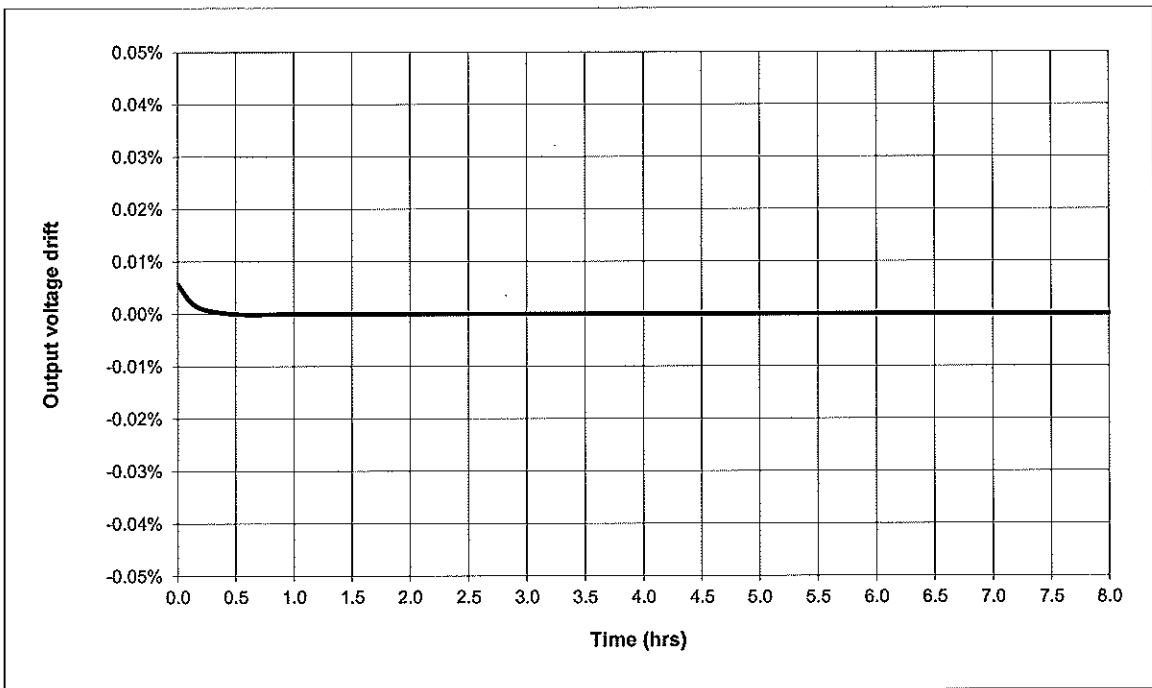

C.C mode

Z36-18

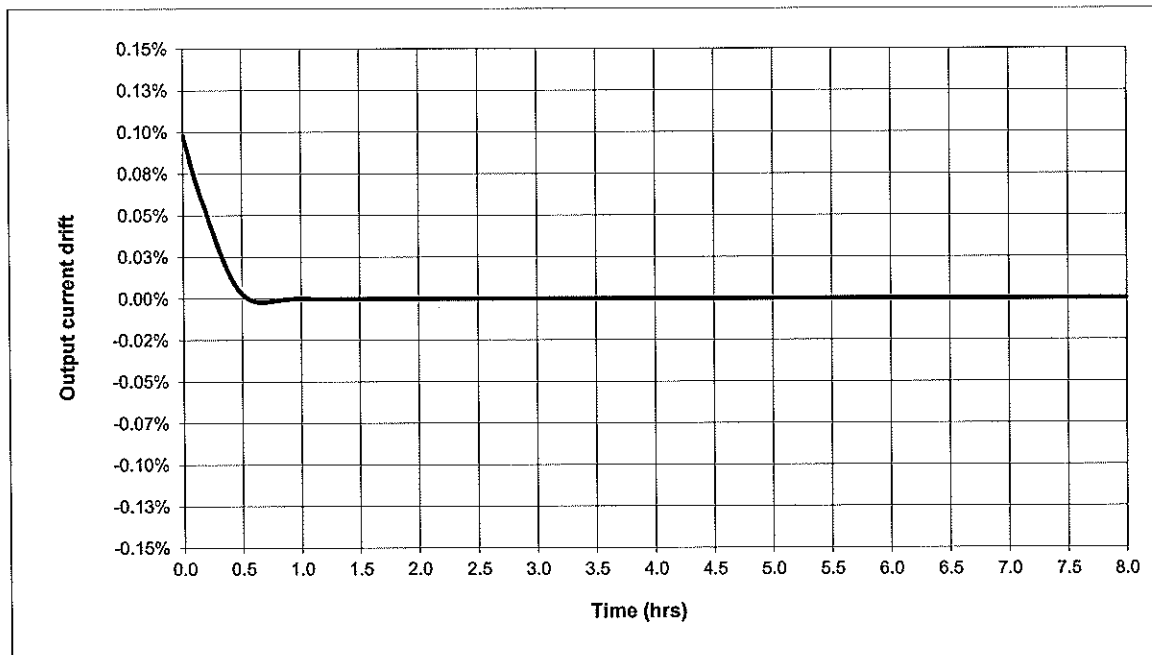

2.2 Warm up drift & stability

Conditions: Vin:100Vac
Vout: 100%
Iout: 100%
Ta = 25°C

C.V mode

Z100-6

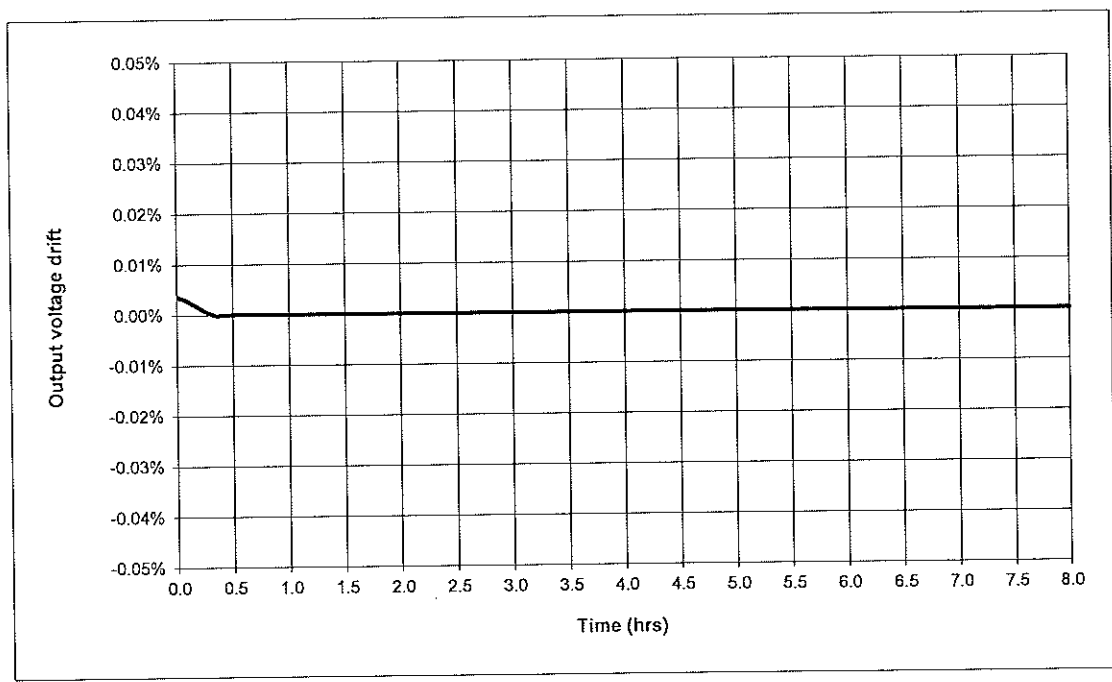

C.C mode

Z100-6

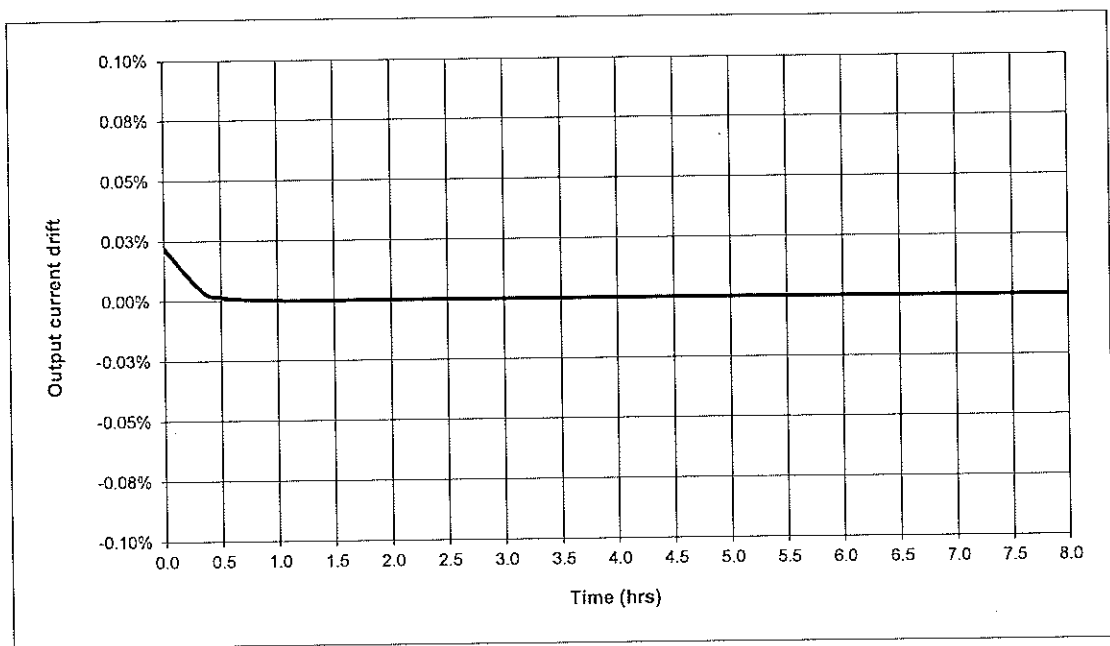

2.3 Over voltage protection (OVP) characteristic

Conditions: Vin:100Vac
Iout: 0%
Ta = 25°C

Z10-60

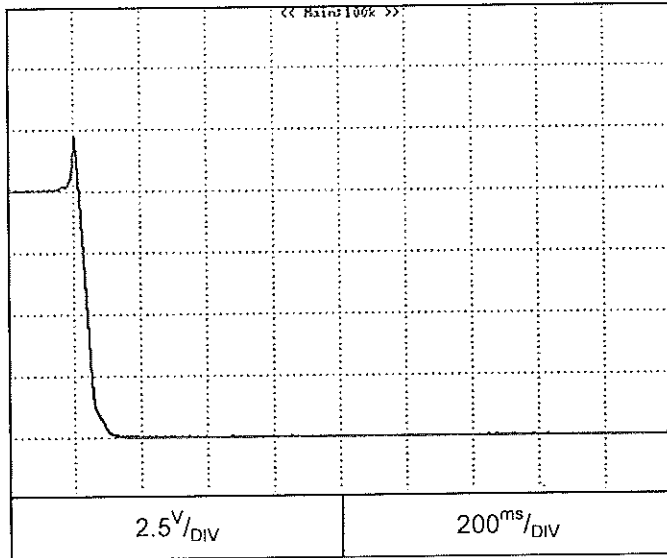

OVP setting:12V

Z36-6

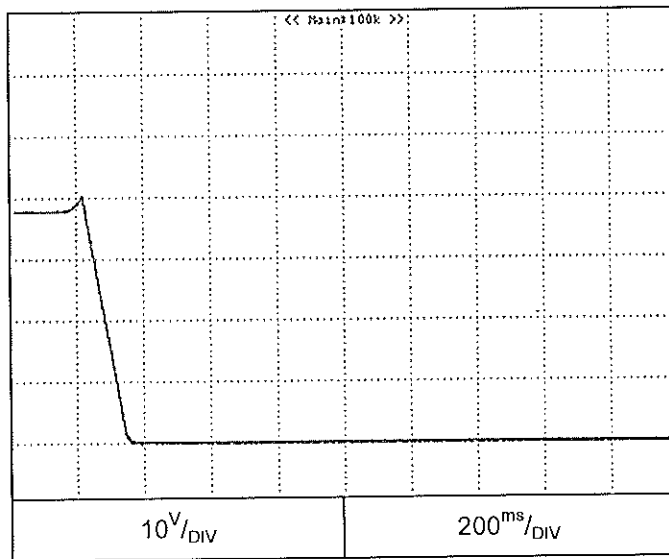

OVP setting: 40V

2.3 Over voltage protection (OVP) characteristic

Conditions: Vin:100Vac
Iout: 0%
Ta = 25°C

Z100-6

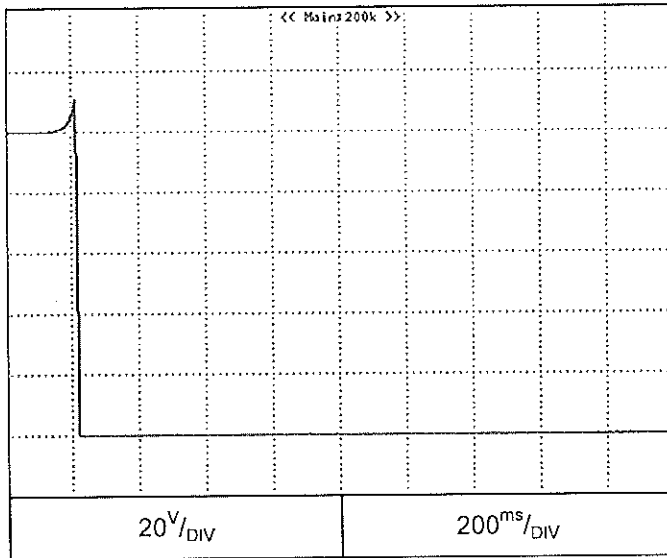

OVP setting: 110V

2.4 ON/OFF Output rise characteristics

Conditions: Vin:100Vac
Vout: 100%
Iout: 0%
Iset=105%
Ta = 25°C

Z10-60

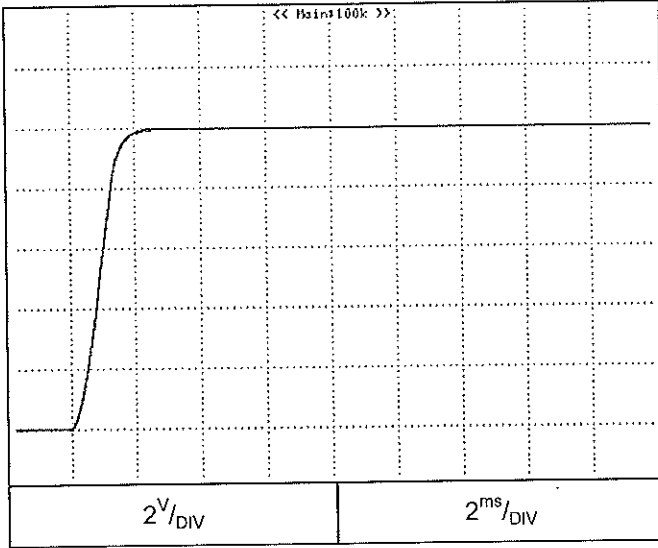

Z36-6

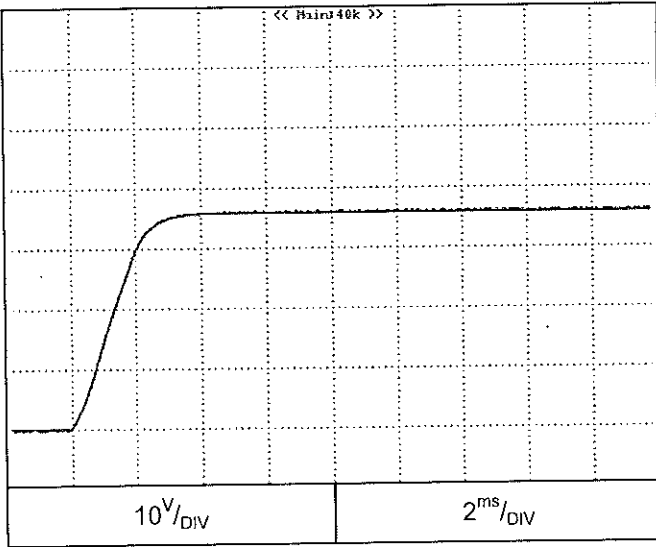

2.4 ON/OFF Output rise characteristics

C.V mode

Z100-6

Conditions: V_{in} :100Vac
 V_{out} : 100%
 I_{out} : 0%
 I_{set} =105%
 T_a = 25°C

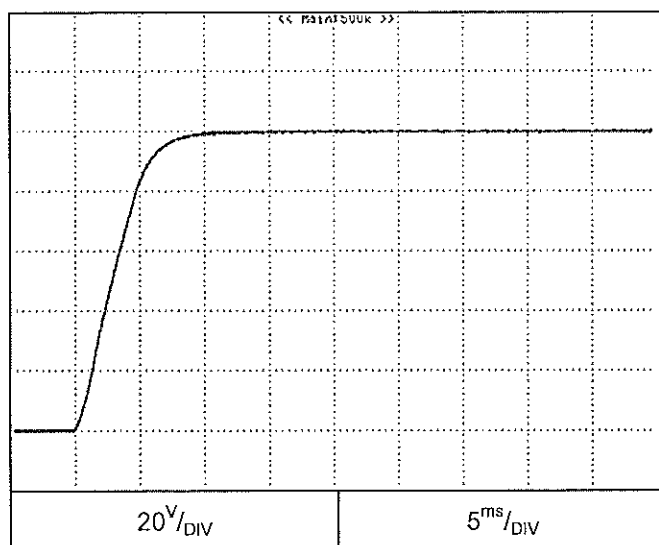

2.4 ON/OFF Output rise characteristics

C.V mode

Conditions: Vin:100Vac
Vout: 100%
Iout: 100%
Iset=105%
Load: CR
Ta = 25°C

Z10-60

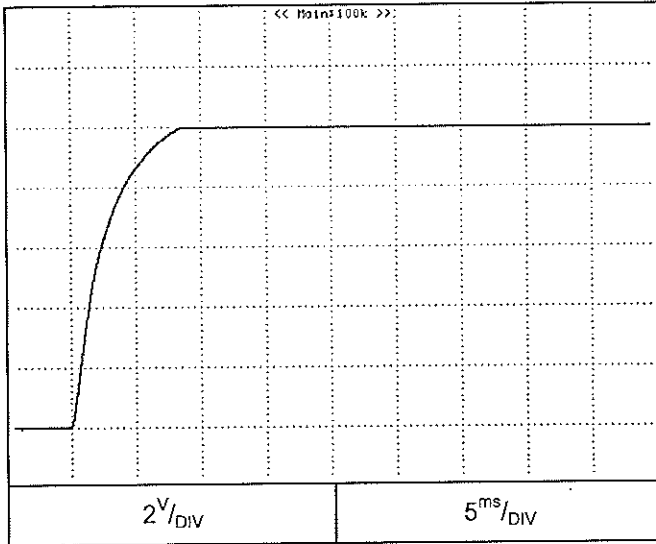

Z36-18

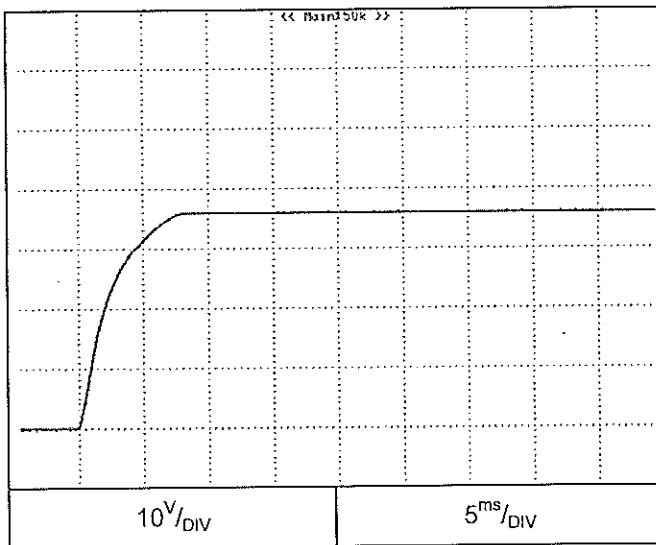

2.4 ON/OFF Output rise characteristics

C.V mode

Z100-6

Conditions: Vin:100Vac
Vout: 100%
Iout: 100%
Iset=105%
Load: CR
Ta = 25°C

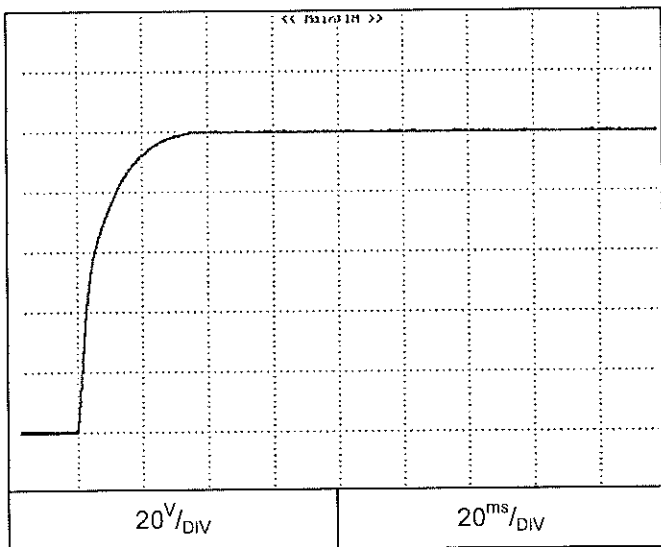

2.4 ON/OFF Output rise characteristics

C.C mode

Conditions: Vin:100Vac
Vout: 100%
Iout: 100%
Vset=105%
Load: CR
Ta = 25°C

Z10-60

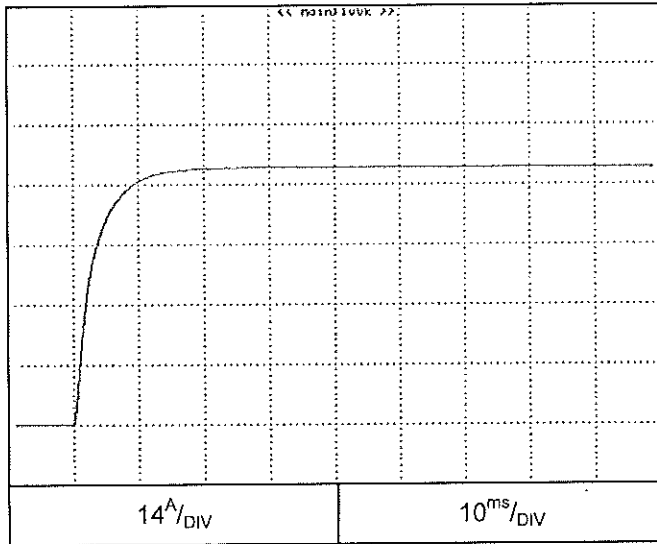

Z36-18

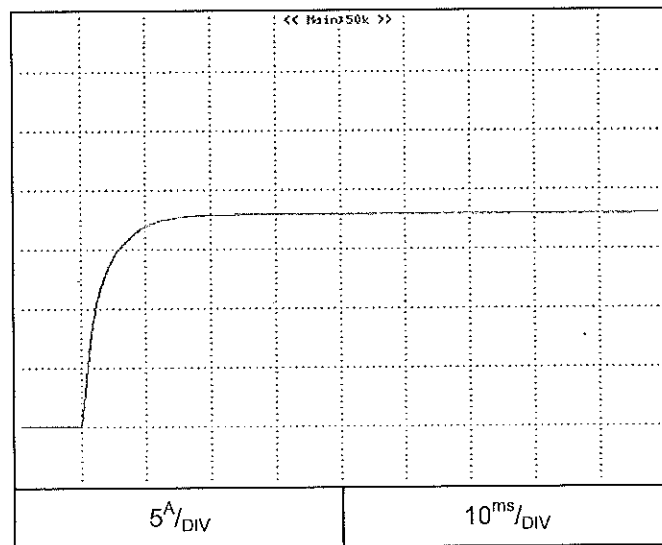

2.4 ON/OFF Output rise characteristics

C.C mode

Z100-6

Conditions: Vin:100Vac
Vout: 100%
Iout: 100%
Vset=105%
Load: CR
Ta = 25°C

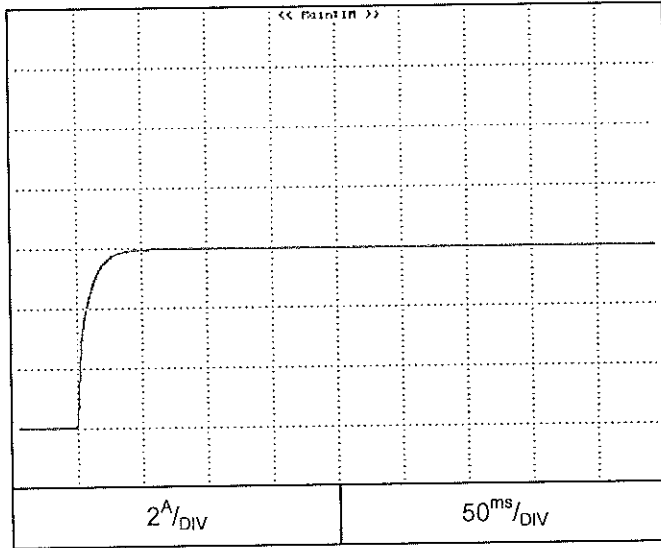

2.4 ON/OFF Output rise characteristics

Conditions: V_{in} : 100Vac
 I_{out} : 100%
 V_{set} : 105%
shorted output
 $T_a = 25^\circ\text{C}$

C.C mode

Z10-60

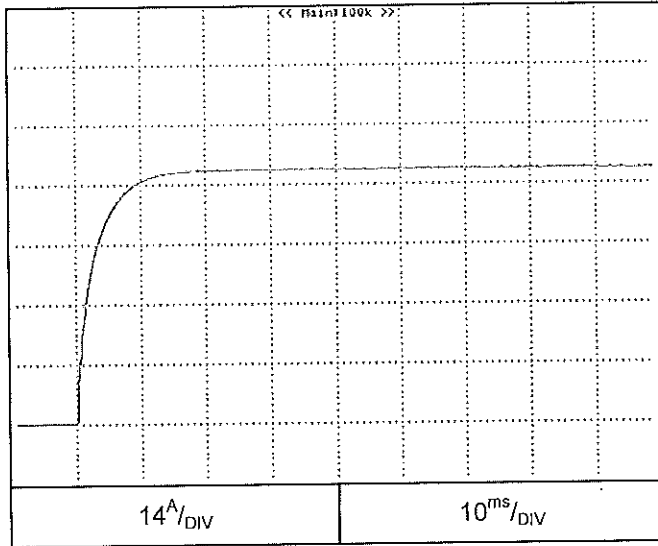

Z36-18

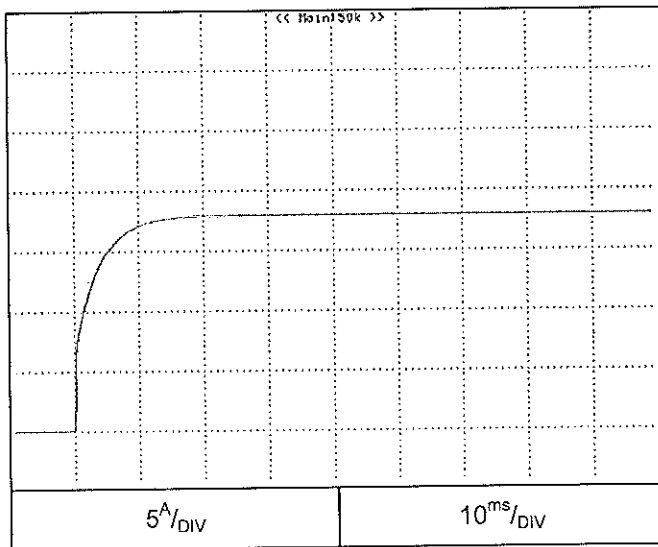

2.4 ON/OFF Output rise characteristics

C.C mode

Conditions: Vin:100Vac
Iout: 100%
Vset=105%
shorted output
Ta = 25°C

Z100-6

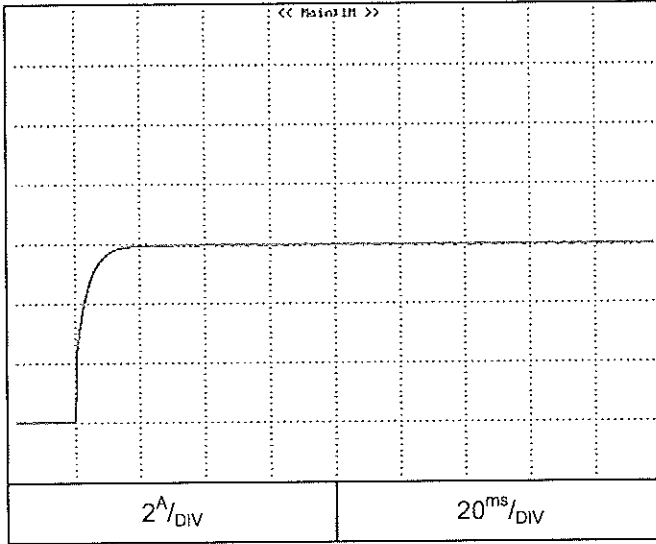

2.5 ON/OFF Output fall characteristics

Conditions: Vin:100Vac
Vout: 100%
Iout: 0%
Iset=105%
Ta = 25°C

C.V mode

Z10-60

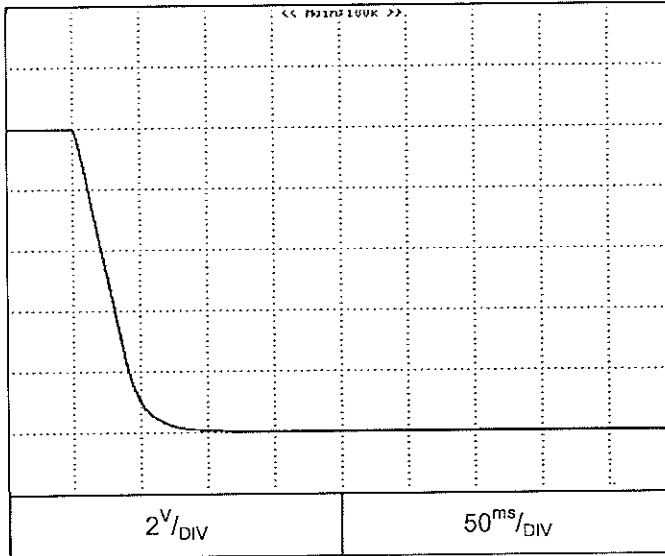

Z36-18

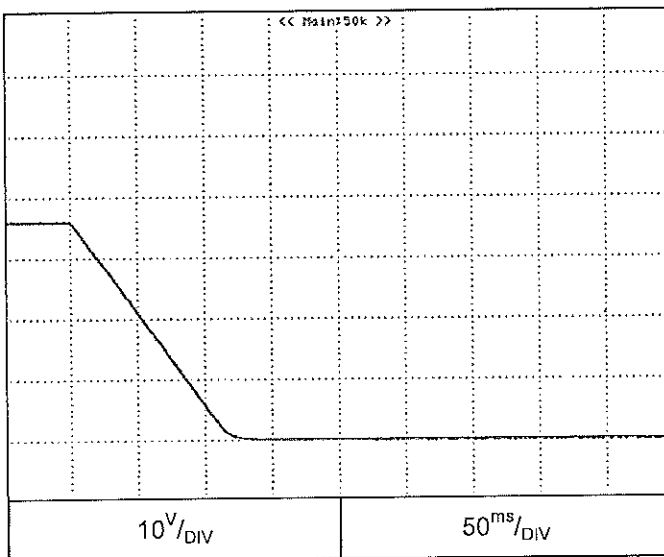

2.5 ON/OFF Output fall characteristics

C.V mode

Z100-6

Conditions: Vin:100Vac
Vout: 100%
Iout: 0%
Iset=105%
Ta = 25°C

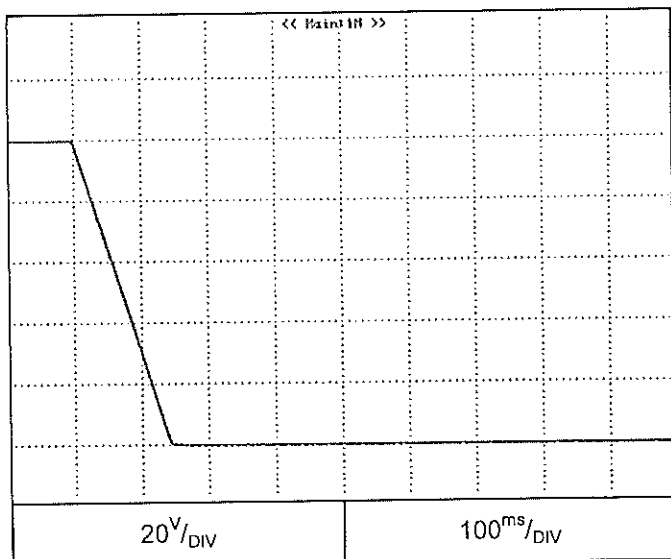

2.5 ON/OFF Output fall characteristics

C.V mode

Z10-60

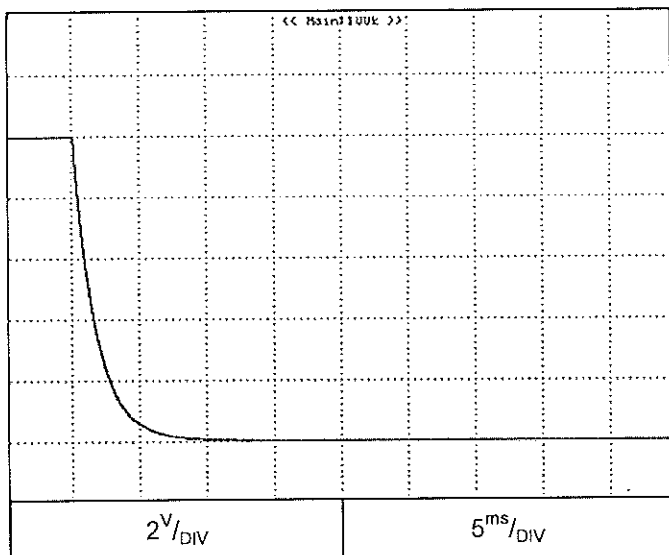

Conditions: V_{in} : 100Vac
 V_{out} : 100%
 I_{out} : 100%
 I_{set} : 105%
Load: CR
 $T_a = 25^\circ C$

Z36-18

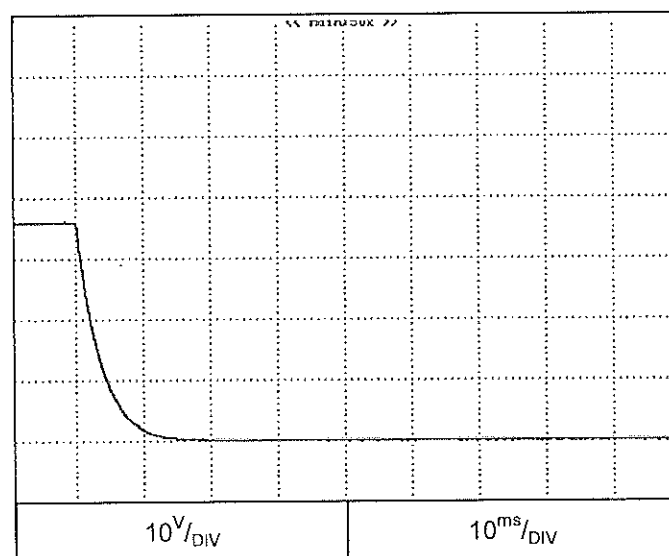

2.5 ON/OFF Output fall characteristics

Conditions: Vin:100Vac
Vout: 100%
Iout: 100%
Iset=105%
Load: CR
Ta = 25°C

C.V mode

Z100-6

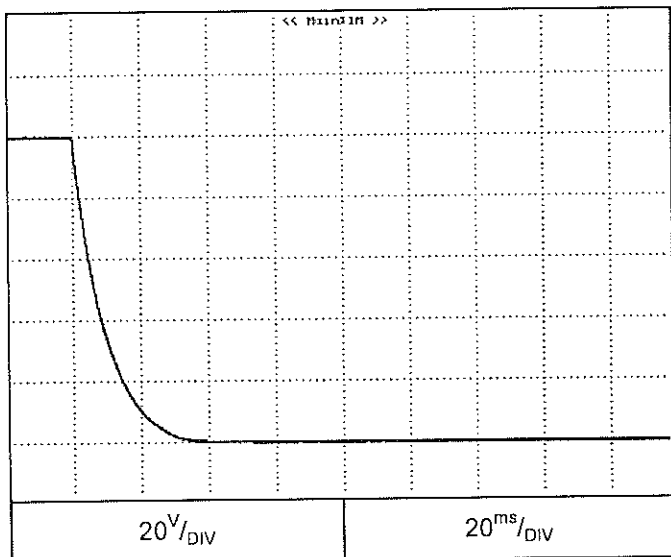

2.5 ON/OFF Output fall characteristics

C.C mode

Z10-60

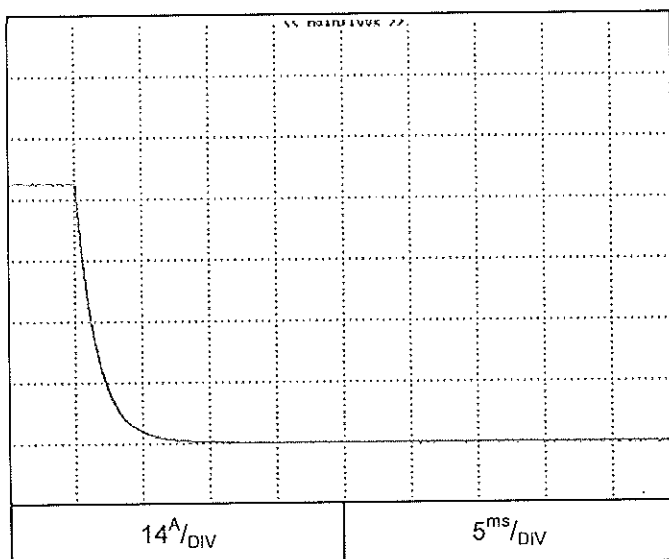

Conditions: V_{in} : 100Vac
 V_{out} : 100%
 I_{out} : 100%
 V_{set} : 105%
Load: CR
 T_a = 25°C

Z36-18

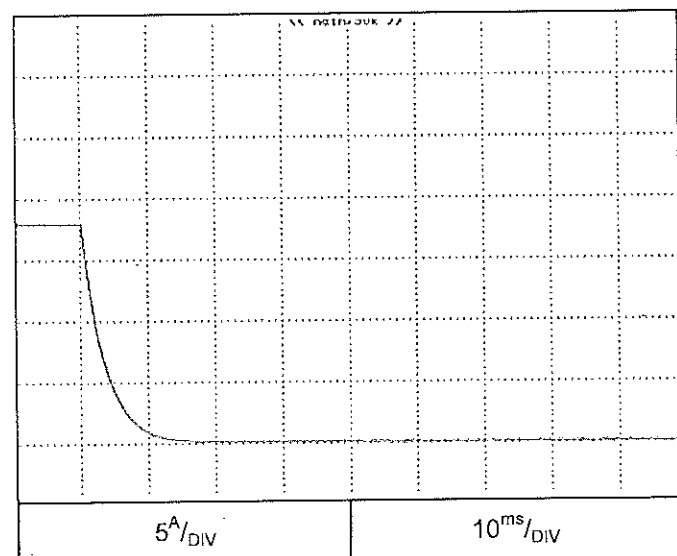

2.5 ON/OFF Output fall characteristics

C.C mode

Z100-6

Conditions: Vin:100Vac
Vout: 100%
Iout: 100%
Vset=105%
Load: CR
Ta = 25°C

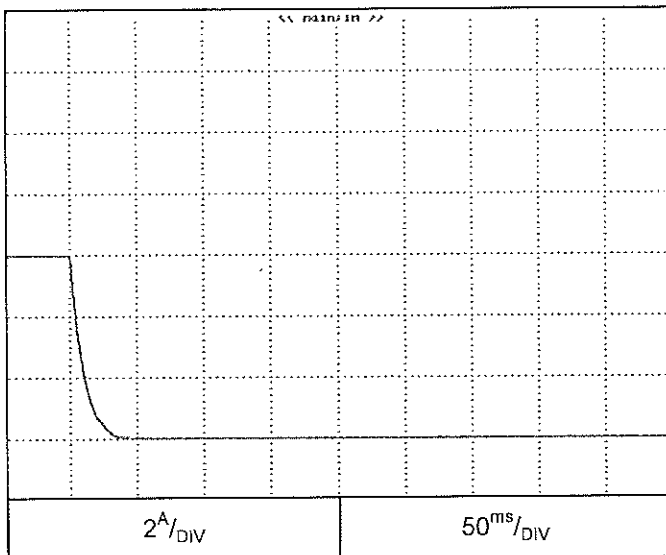

2.5 ON/OFF Output fall characteristics

C.C mode

Conditions: V_{in} : 100Vac
 I_{out} : 100%
 V_{set} : 105%
shorted output
 $T_a = 25^\circ\text{C}$

Z10-60

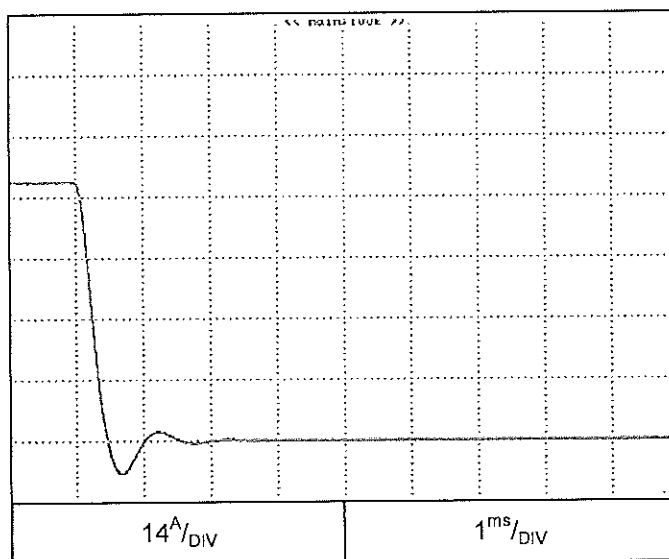

Z36-18

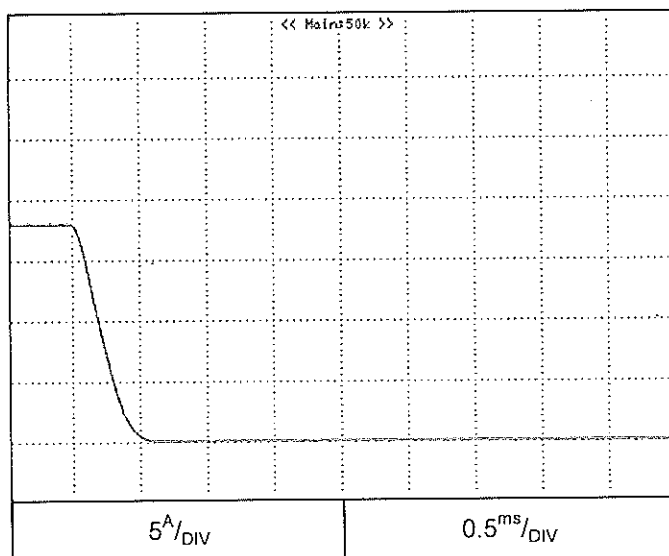

2.5 ON/OFF Output fall characteristics

C.C mode

Z100-6

Conditions: Vin:100Vac
Iout: 100%
Vset=105%
shorted output
Ta = 25°C

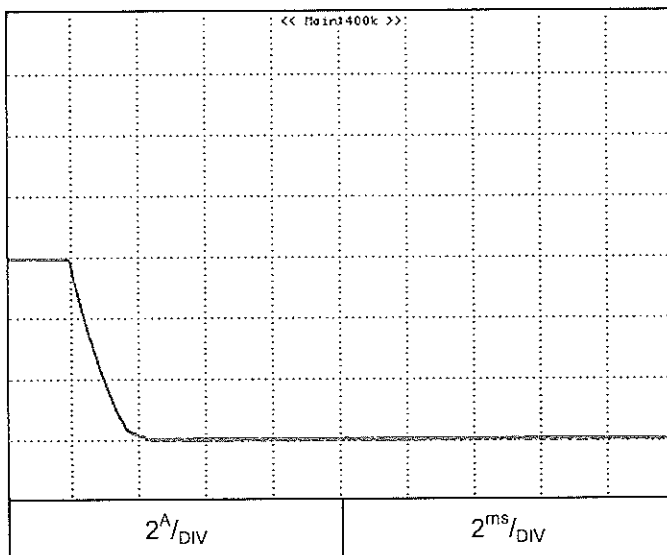

2.6 Hold up time characteristics

Conditions: Vin:100Vac
Vout: 100%
Ta = 25°C

Z10-60

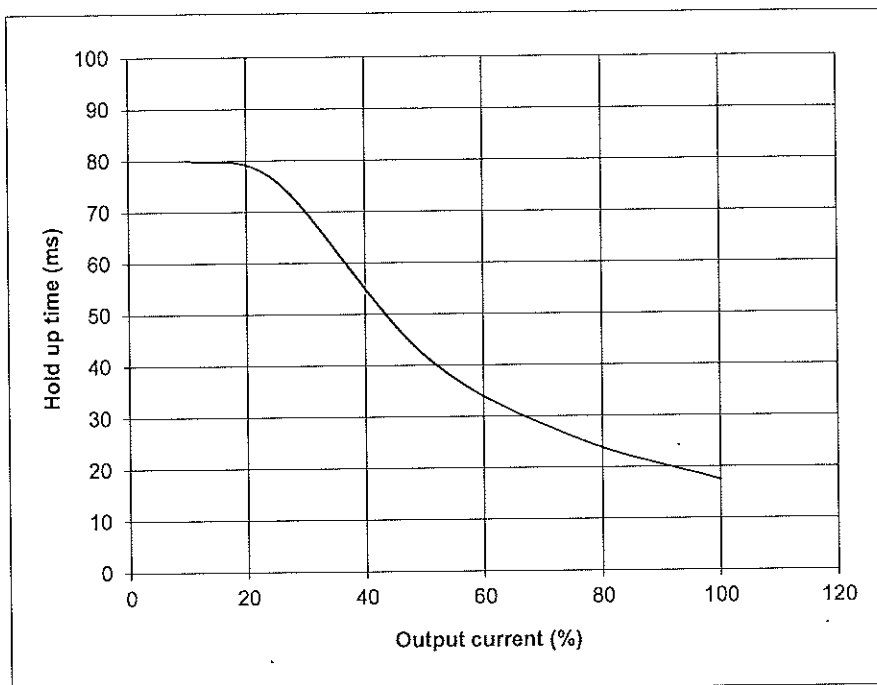

2.6 Hold up time characteristics

Conditions: V_{in} : 100Vac
 V_{out} : 100%
 T_a = 25°C

Z36-18

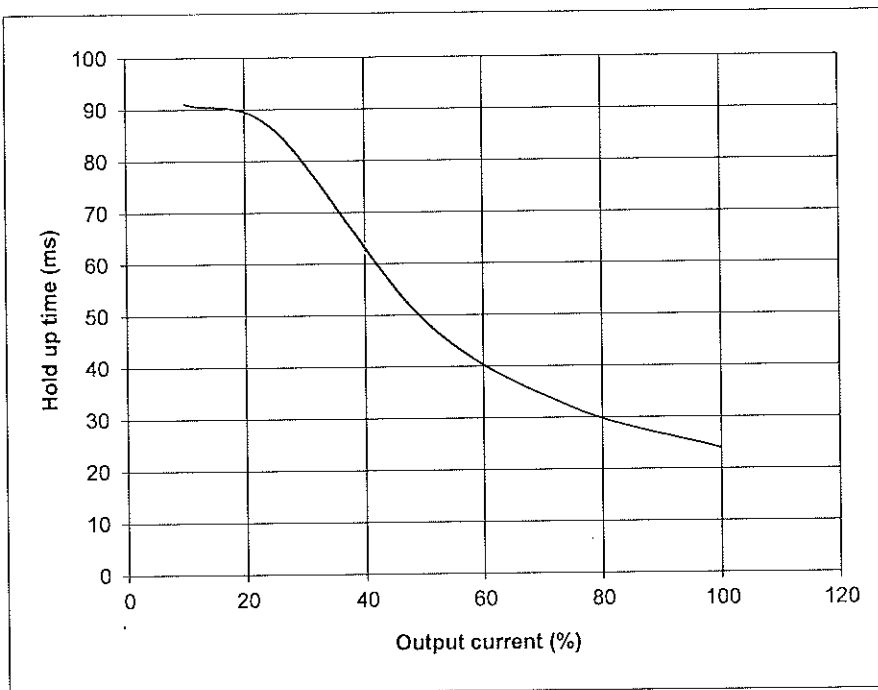

2.6 Hold up time characteristics

Conditions: V_{in} :100Vac
 V_{out} : 100%
 $T_a = 25^{\circ}\text{C}$

Z100-6

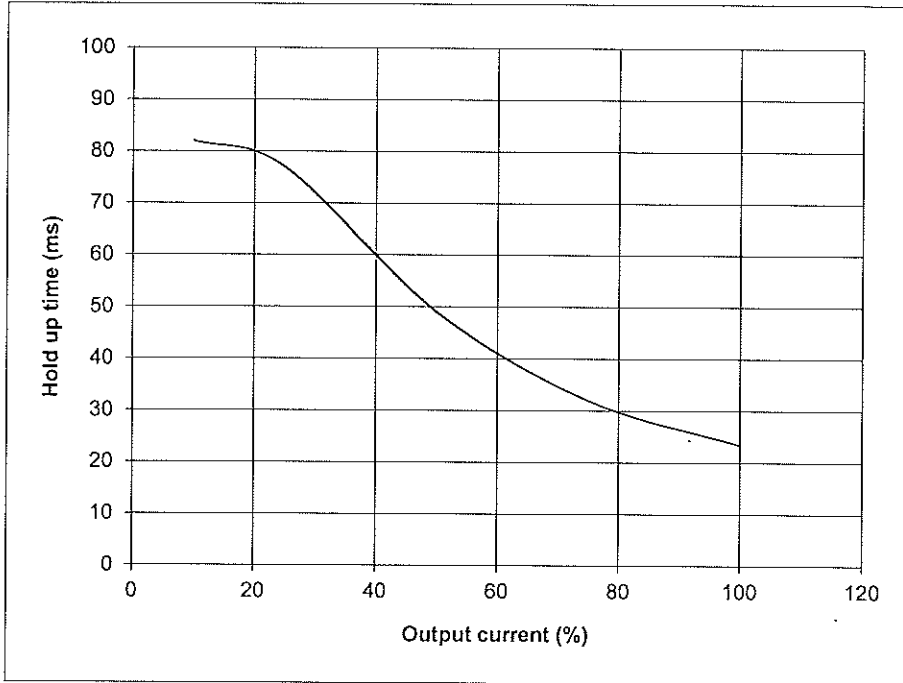

2.7 Dynamic line response characteristics

Conditions: Vin:85↔132V
 Vout: 100%
 Iout: 100%
 Ta = 25°C

C.V mode

Z10-60

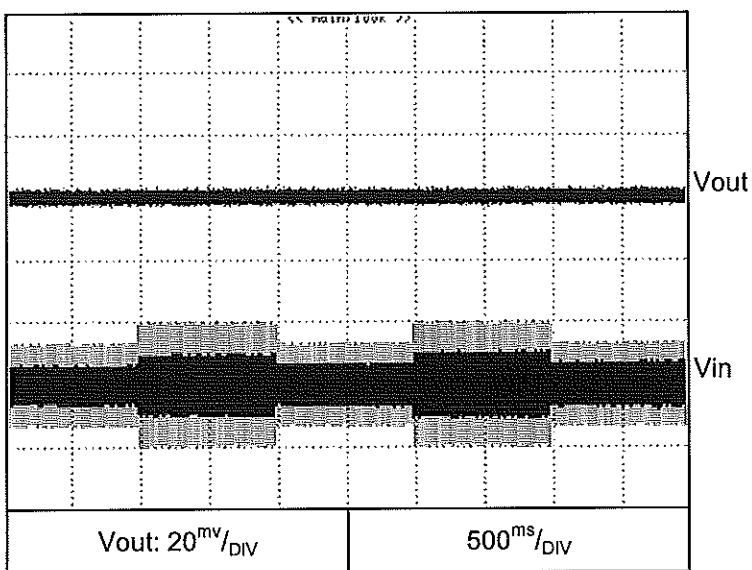

Conditions: Vin:170↔265V
 Vout: 100%
 Iout: 100%
 Ta = 25°C

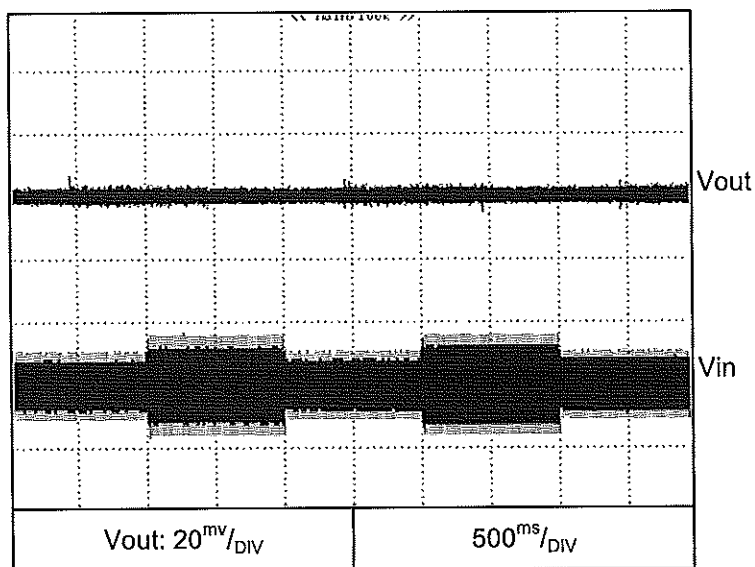

2.7 Dynamic line response characteristics

Conditions: Vin:85↔132V
Vout: 100%
Iout: 100%
Ta = 25°C

C.V mode

Z36-18

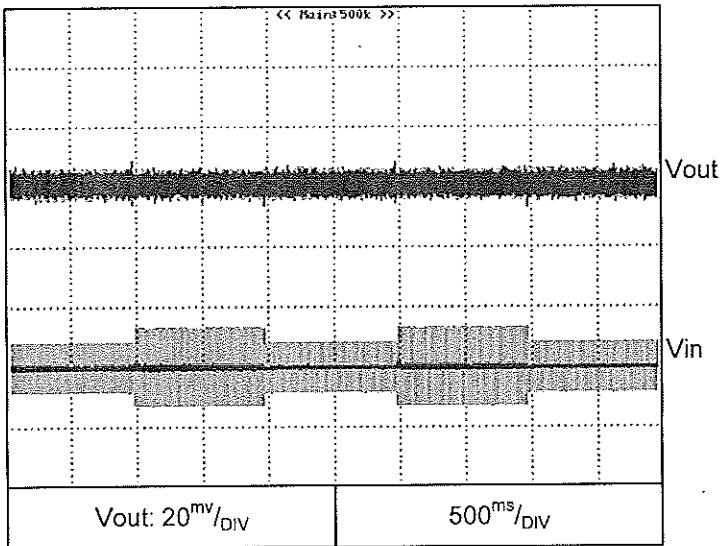

Conditions: Vin:170↔265V
Vout: 100%
Iout: 100%
Ta = 25°C

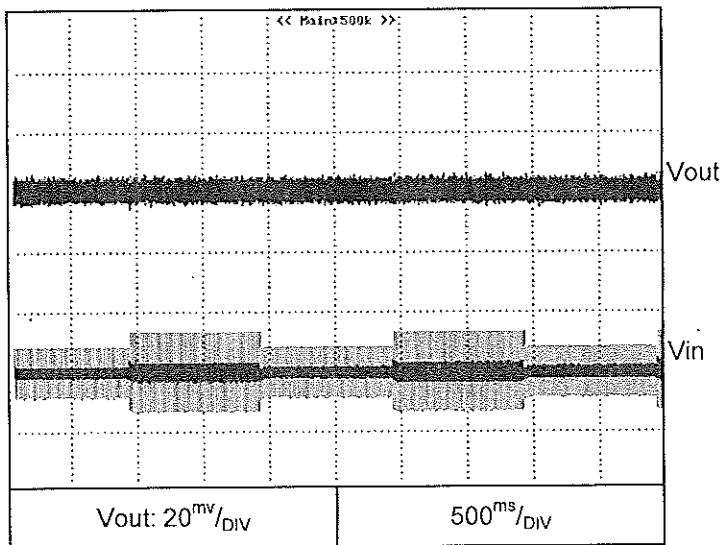

2.7 Dynamic line response characteristics

Conditions: Vin:85↔132V
Vout: 100%
Iout: 100%
Ta = 25°C

C.V mode

Z100-6

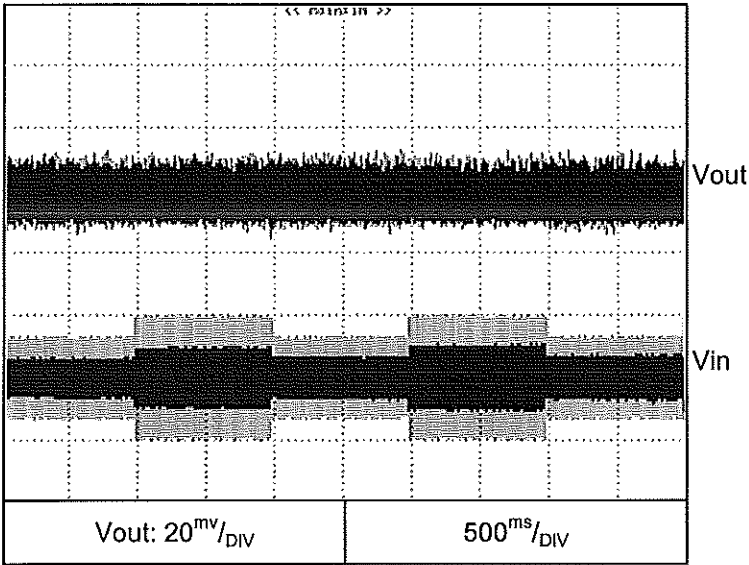

Conditions: Vin:170↔265V
Vout: 100%
Iout: 100%
Ta = 25°C

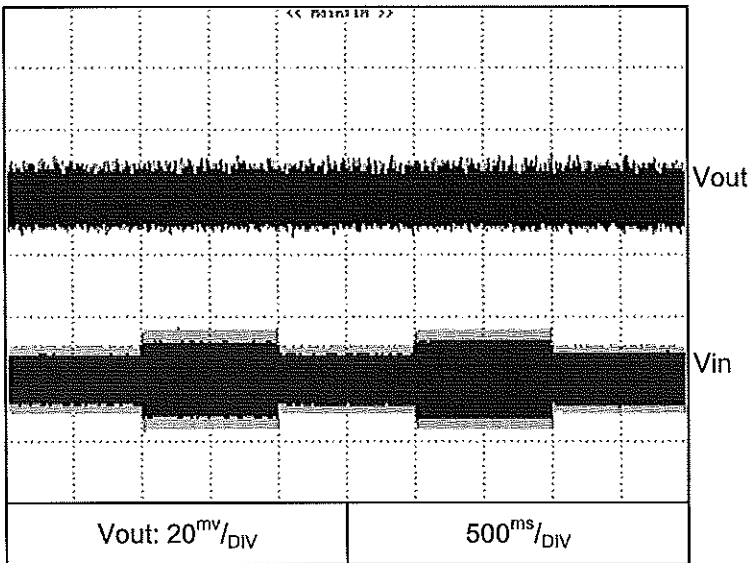

2.7 Dynamic line response characteristics

Conditions: $V_{in}: 85 \leftrightarrow 132V$
 $V_{out}: 100\%$
 $I_{out}: 100\%$
 $T_a = 25^{\circ}C$

C.C mode

Z10-60

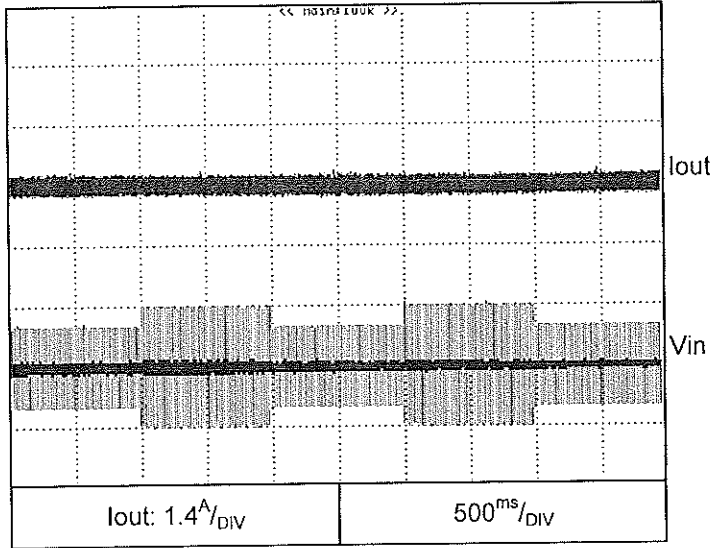

Conditions: $V_{in}: 170 \leftrightarrow 265V$
 $V_{out}: 100\%$
 $I_{out}: 100\%$
 $T_a = 25^{\circ}C$

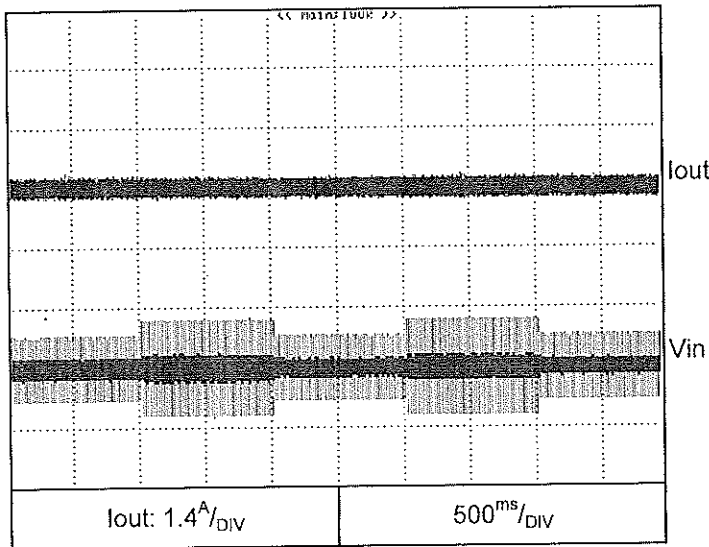

2.7 Dynamic line response characteristics

Conditions: Vin:85↔132V
Vout: 100%
Iout: 100%
Ta = 25°C

C.C mode

Z36-18

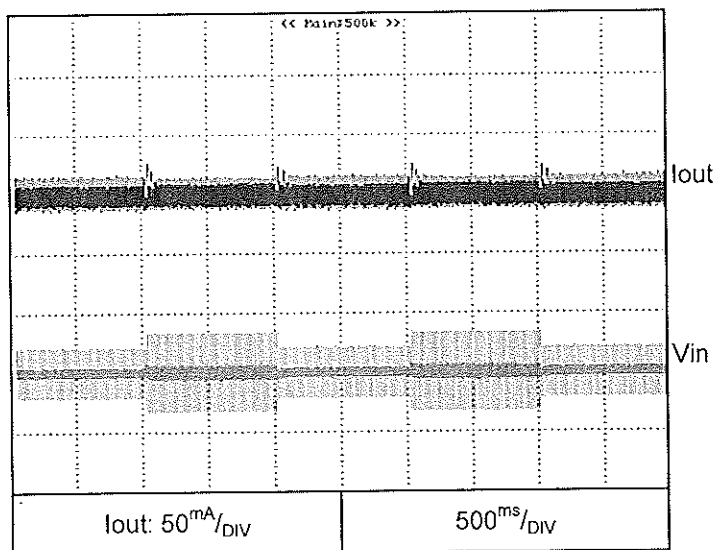

Conditions: Vin:170↔265V
Vout: 100%
Iout: 100%
Ta = 25°C

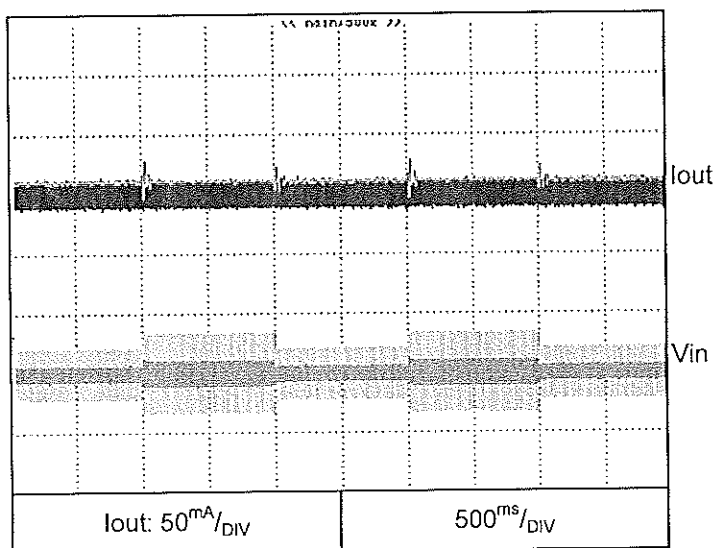

2.7 Dynamic line response characteristics

Conditions: Vin:85↔132V
Vout: 100%
Iout: 100%
Ta = 25°C

C.C mode

Z100-6

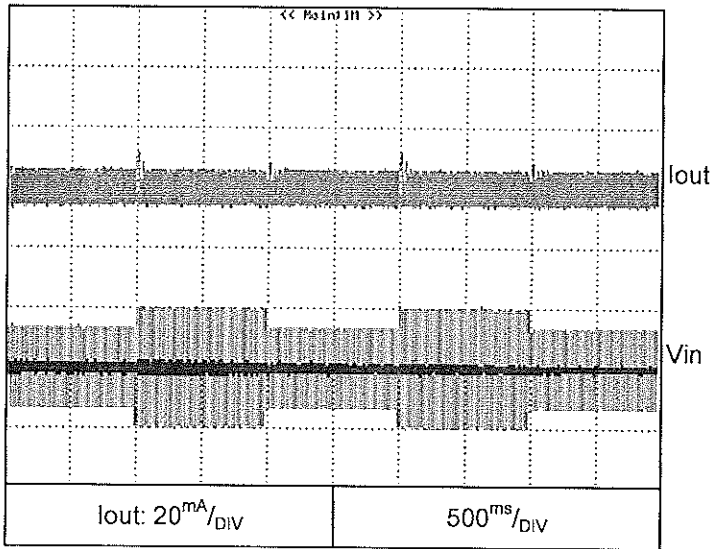

Conditions: Vin:170↔265V
Vout: 100%
Iout: 100%
Ta = 25°C

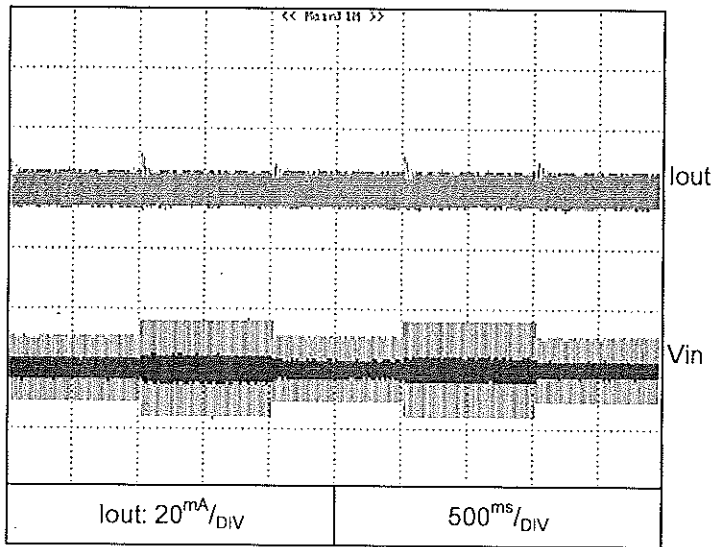

2.8 Dynamic load response characteristics

Conditions: $V_{in}: 100V_{ac}$
 $V_{out}: 100\%$
 $T_a = 25^{\circ}C$

C.V mode

Load current: $t_r=t_f=100\mu s$

Z10-60

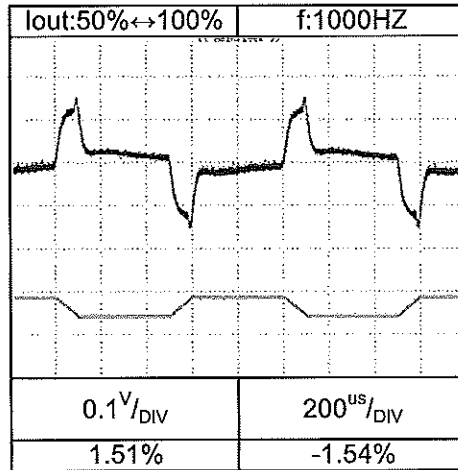
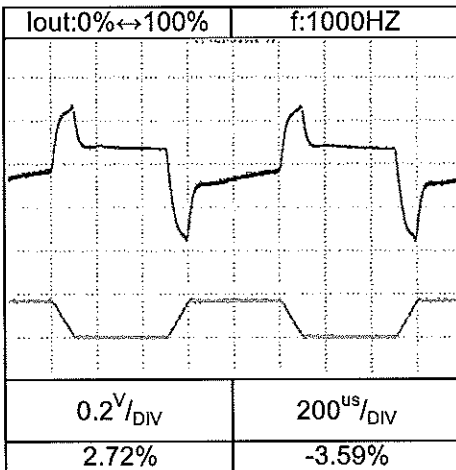
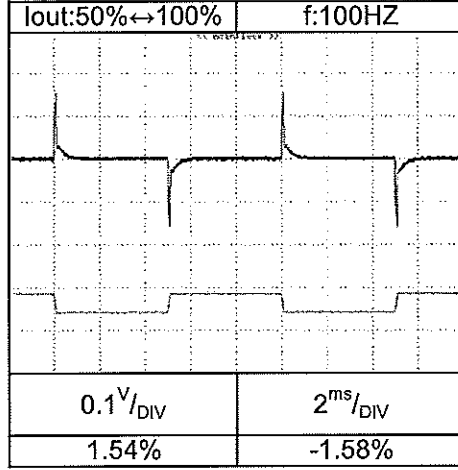
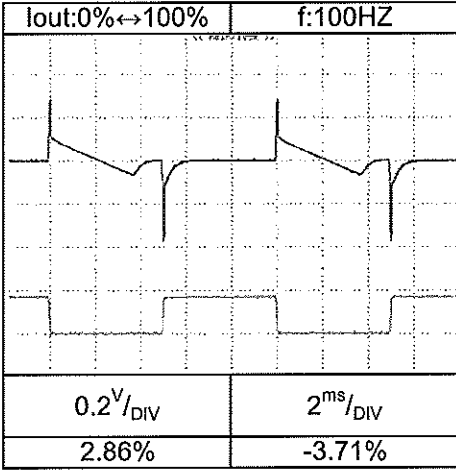

2.8 Dynamic load response characteristics

Conditions: $V_{in}: 100V_{ac}$
 $V_{out}: 100\%$
 $T_a = 25^{\circ}C$

C.V mode

Load current: $t_r = t_f = 100\mu s$

Z36-18

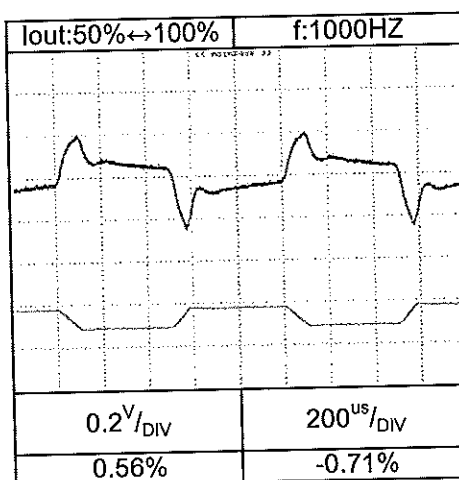
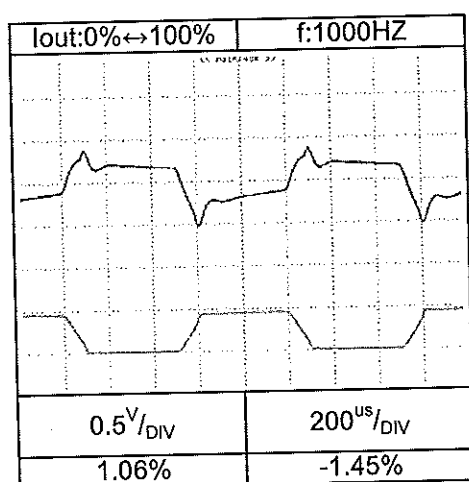
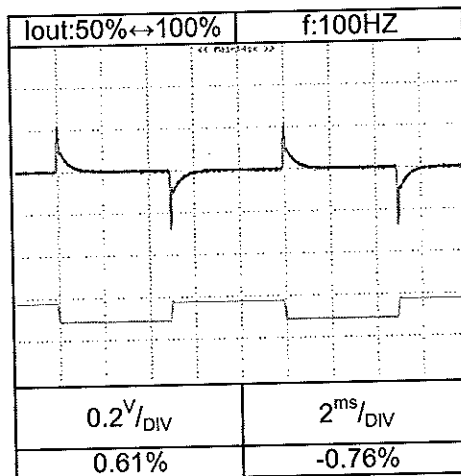
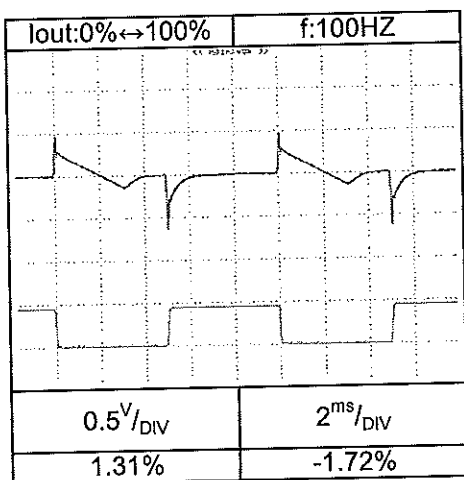

2.8 Dynamic load response characteristics

Conditions: Vin:100Vac
 Vout: 100%
 Ta = 25°C

C.V mode

Load current: tr=tf=100us

Z100-6

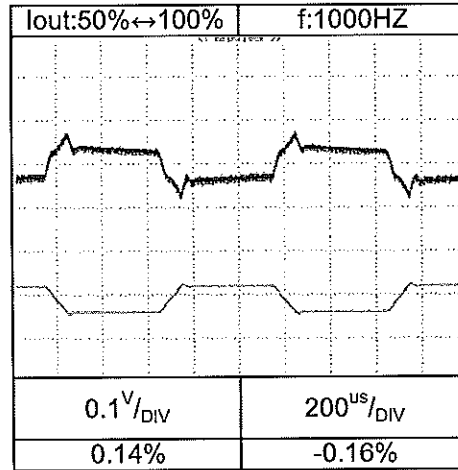
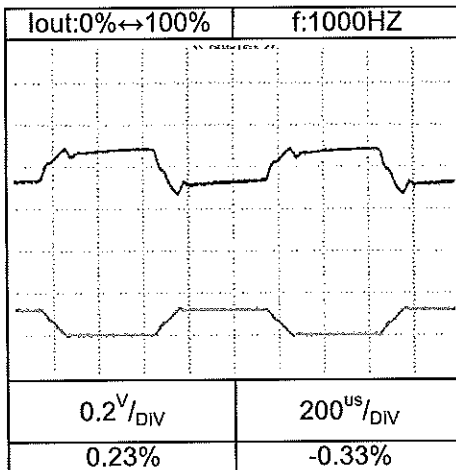
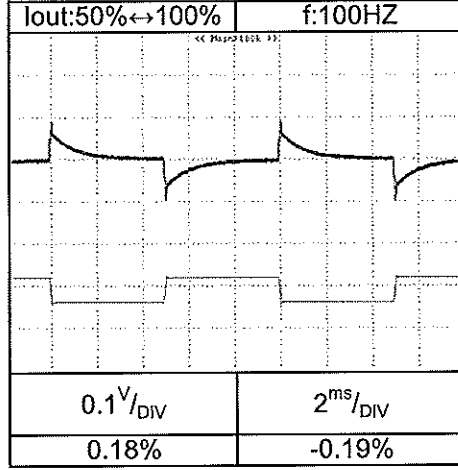
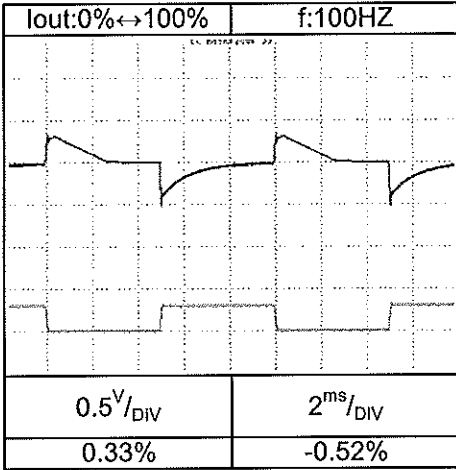

2.8 Dynamic load response characteristics

Conditions: $V_{in}: 100V_{ac}$
 $T_a = 25^{\circ}C$

C.C mode

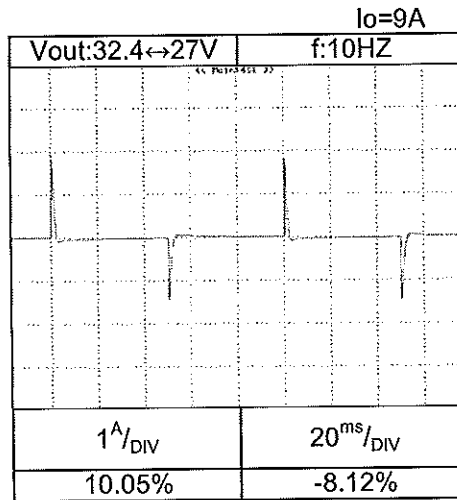
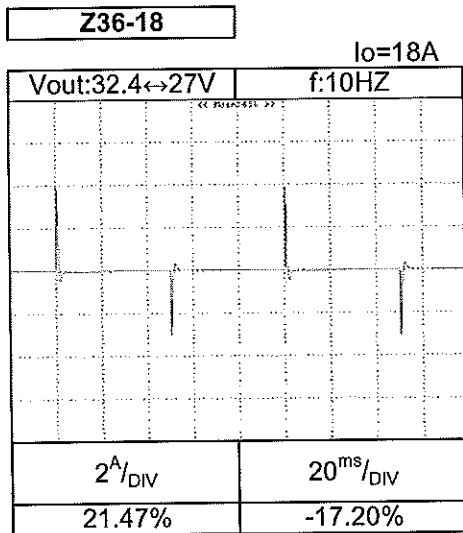
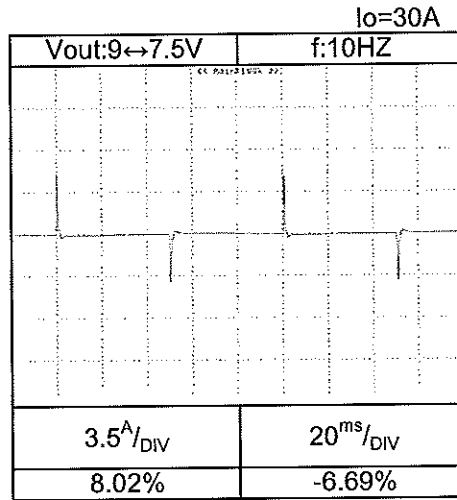
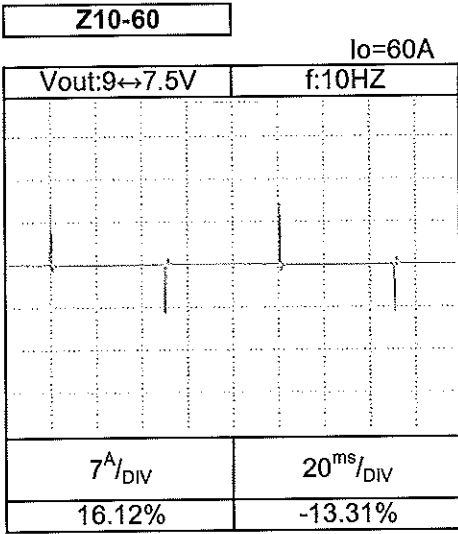

2.8 Dynamic load response characteristics

Conditions: $V_{in}: 100V_{ac}$
 $T_a = 25^{\circ}C$

C.C mode

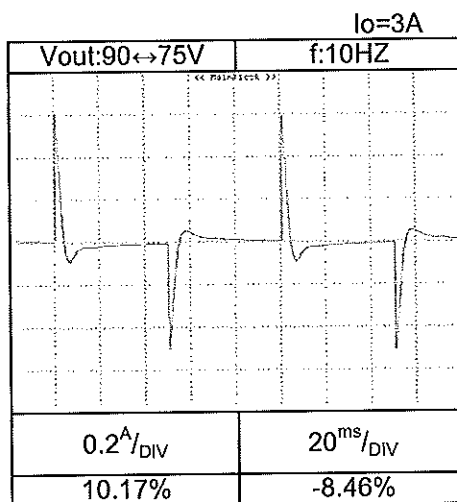
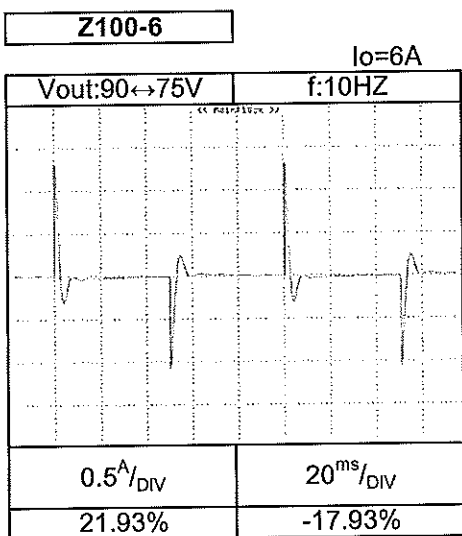

2.9 Response to brown-out characteristics

Conditions: V_{in} :100VAC
 V_{out} : 100%
 I_{out} : 100%
 $T_a = 25^{\circ}\text{C}$

C.V mode

Z10-60

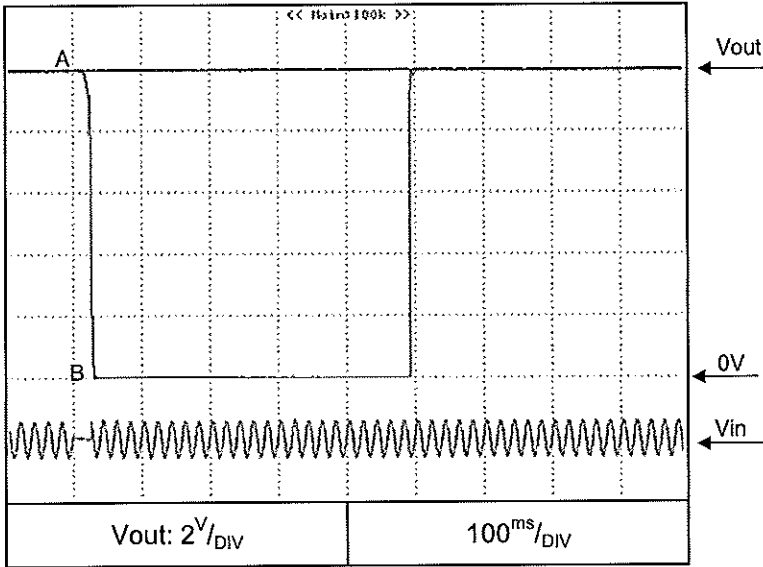

Brown-out time
A -17mS
B -26mS

2.9 Response to brown-out characteristics

Conditions: V_{in} :100VAC
 V_{out} : 100%
 I_{out} : 100%
 $T_a = 25^{\circ}\text{C}$

C.V mode

Z10-60

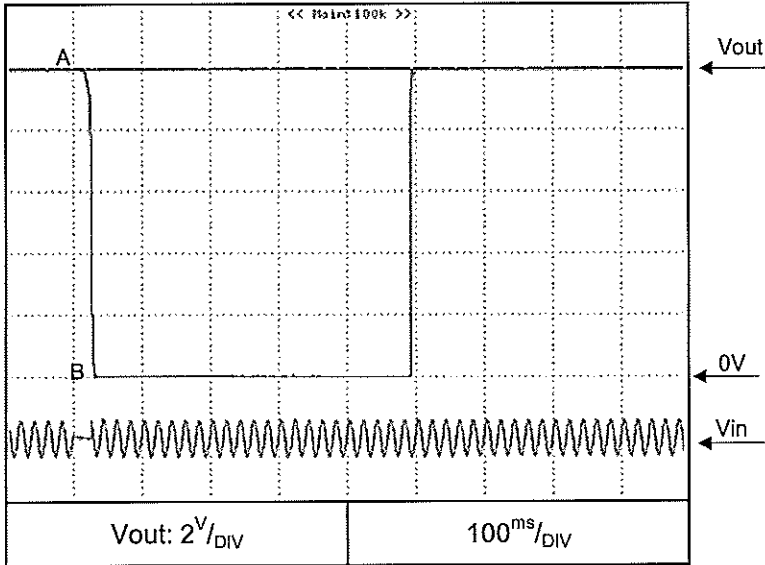

Brown-out time
A -17mS
B -26mS

2.9 Response to brown-out characteristics

Conditions: Vin:100VAC
Vout: 100%
Iout: 100%
Ta = 25°C

C.V mode

Z36-18

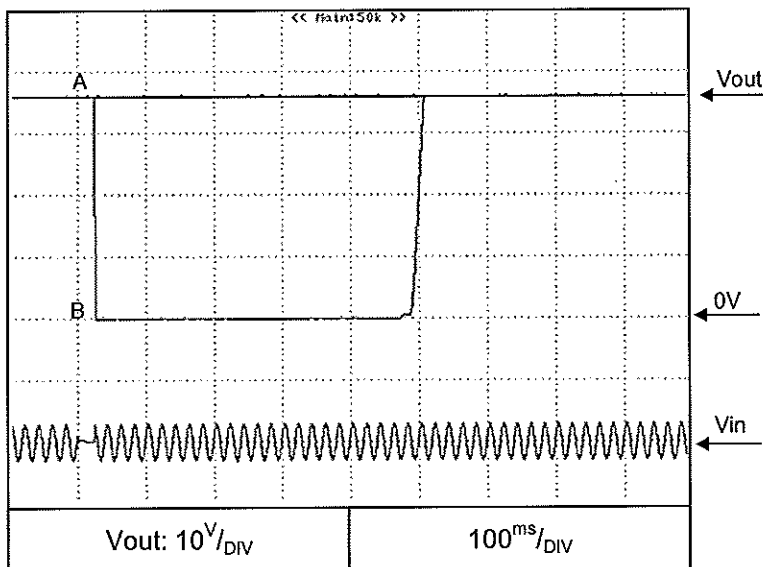

Brown-out time
A - 23ms
B - 24ms

2.9 Response to brown-out characteristics

Conditions: V_{in} : 100VAC
 V_{out} : 100%
 I_{out} : 100%
 $T_a = 25^{\circ}\text{C}$

C.V mode

Z100-6

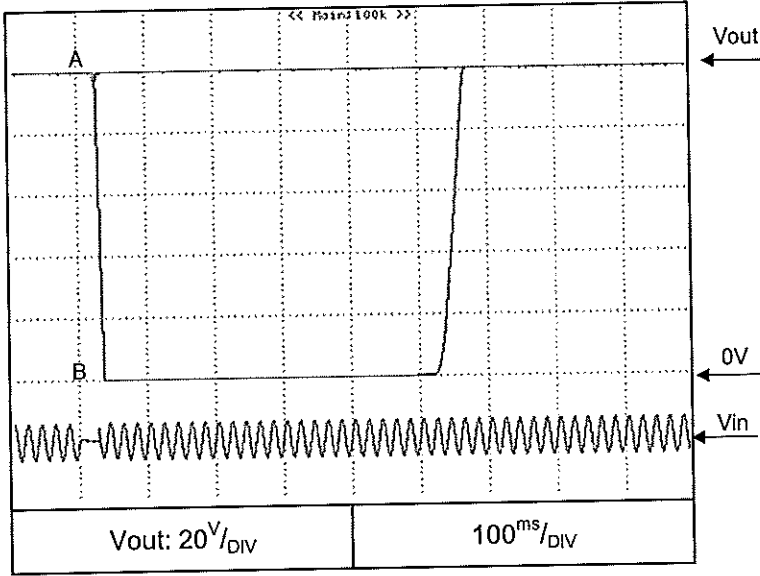

Brown-out time
A - 24ms
B - 27ms

2.9 Response to brown-out characteristics

Conditions: V_{in} : 100VAC
 V_{out} : 100%
 I_{out} : 100%
 $T_a = 25^\circ\text{C}$

C.C mode

Z36-18

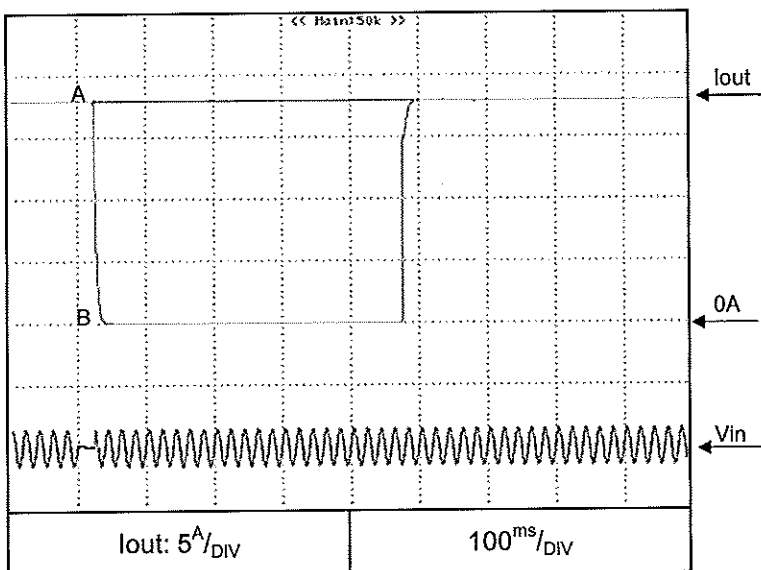

Brown-out time
A - 23ms
B - 24ms

2.9 Response to brown-out characteristics

Conditions: V_{in} : 100VAC
 V_{out} : 100%
 I_{out} : 100%
 $T_a = 25^\circ\text{C}$

C.C mode

Z100-6

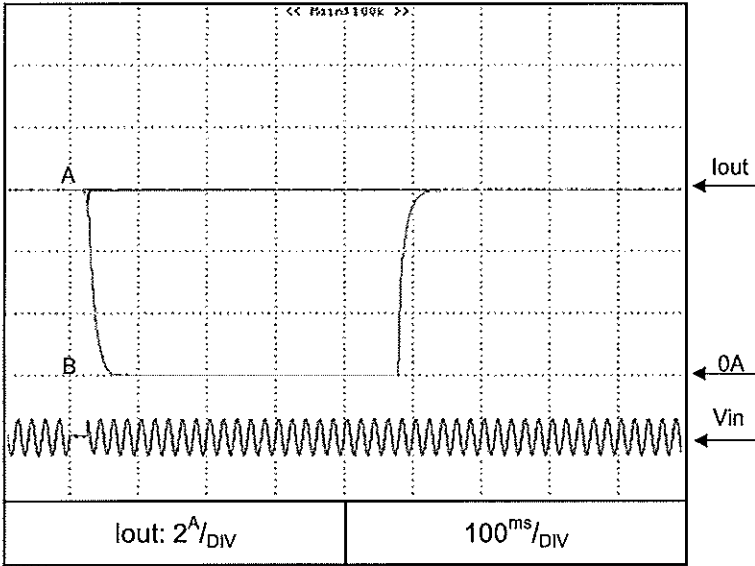

Brown-out time
A - 25ms
B - 26ms

2.10 Inrush Current Characteristics during line brown outs

Conditions: Vin: 100VAC
Vout: 100%
Iout: 0%
Iout: 100%
Ta = 25°C

—————

Z10-60

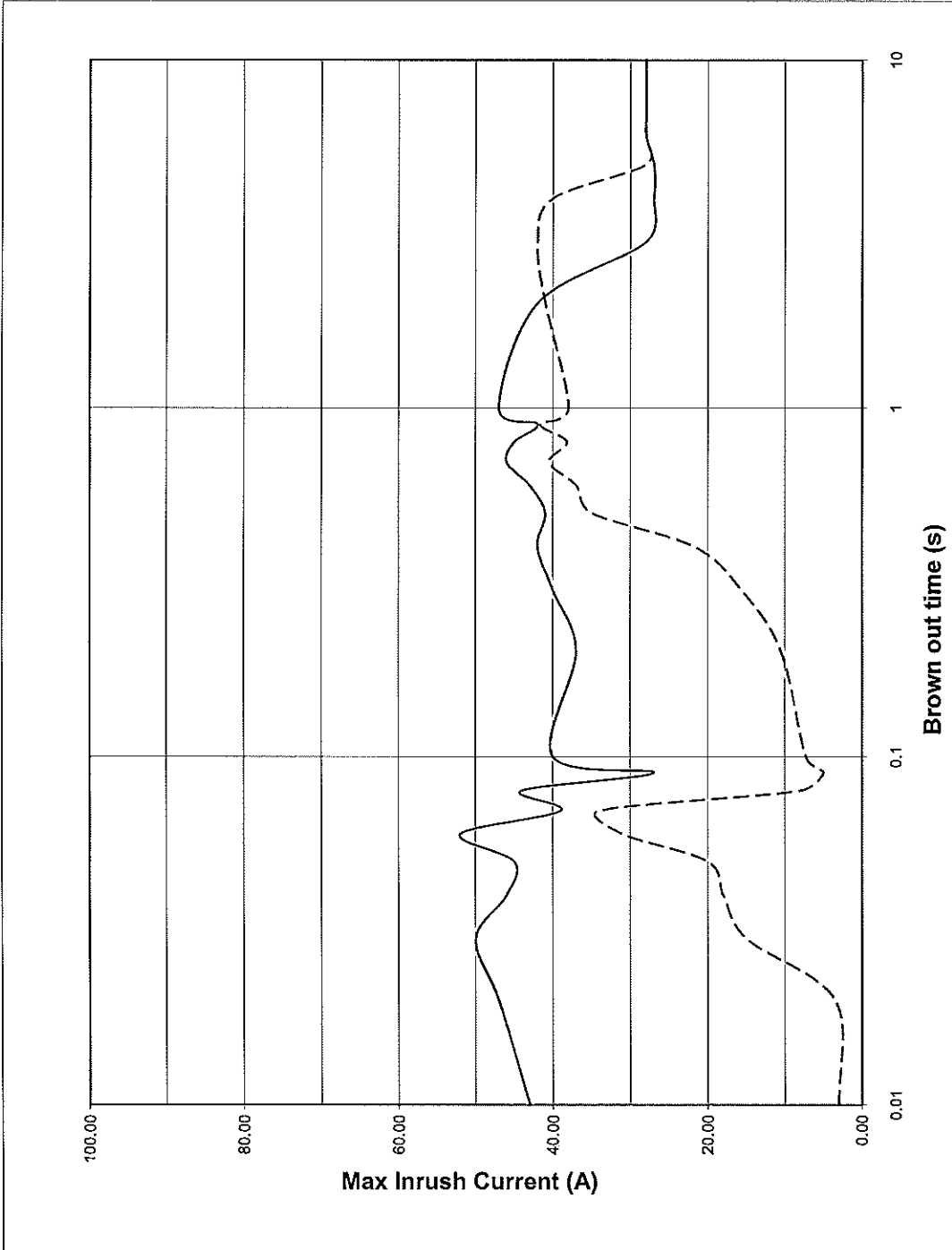

2.10 Inrush Current Characteristics during line brown outs

Conditions: Vin: 200VAC
Vout: 100%
Iout: 0%
Iout: 100%
Ta = 25°C

Z10-60

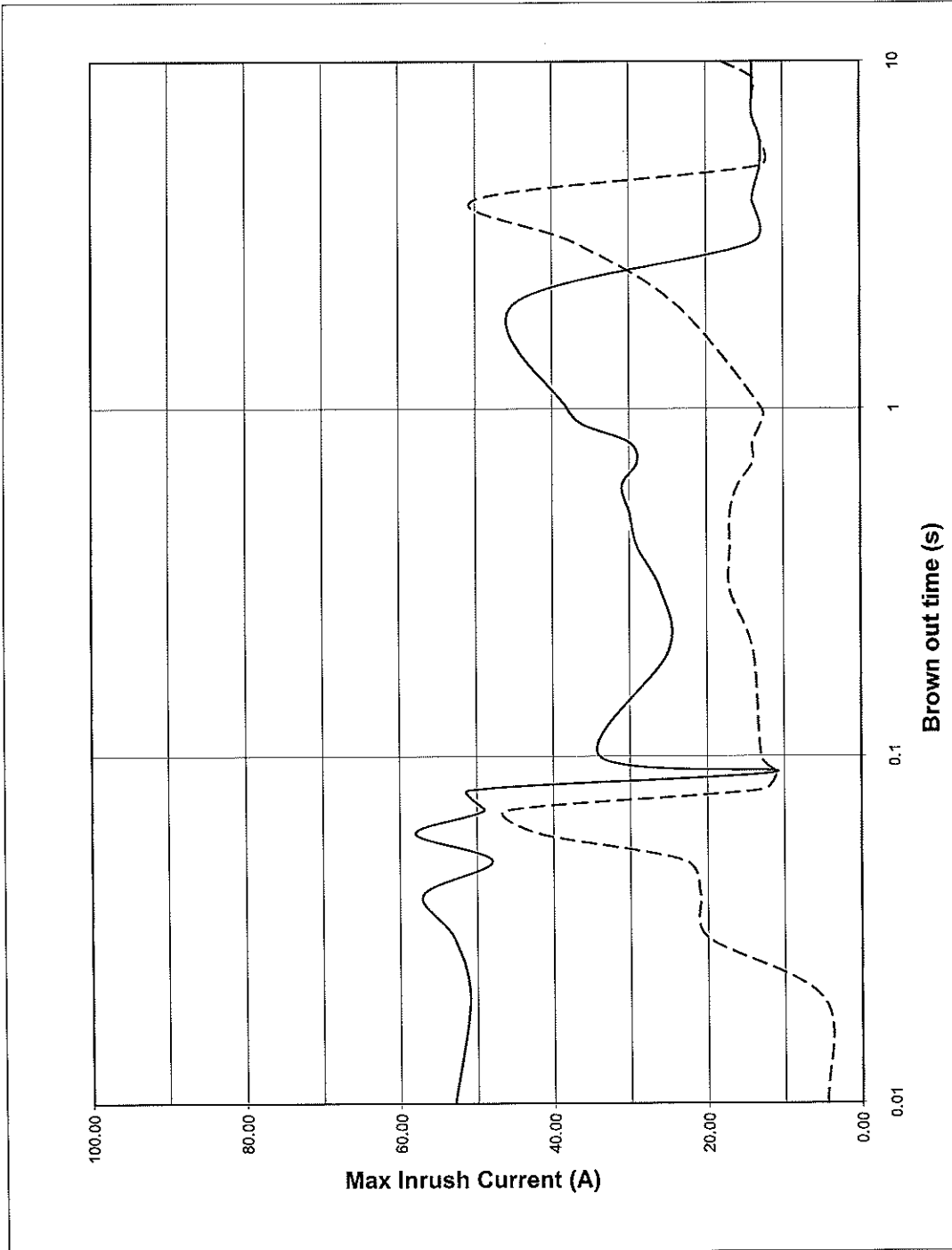

2.11 Inrush current waveform

Conditions: Vin: 100V
 Vout: 100%
 Iout: 100%
 Ta = 25°C

Z10-60

Switch on phase angle of input AC voltage

$\phi=0^\circ$

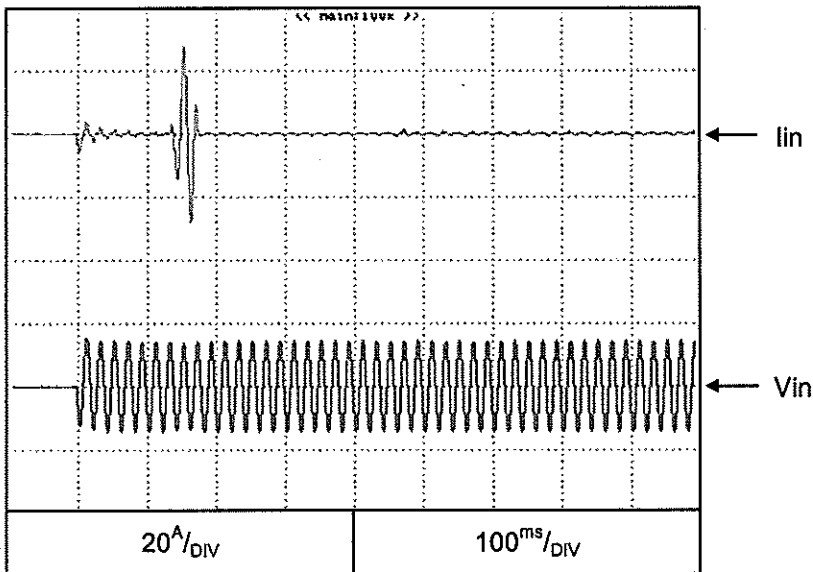

Switch on phase angle of input AC voltage

$\phi=90^\circ$

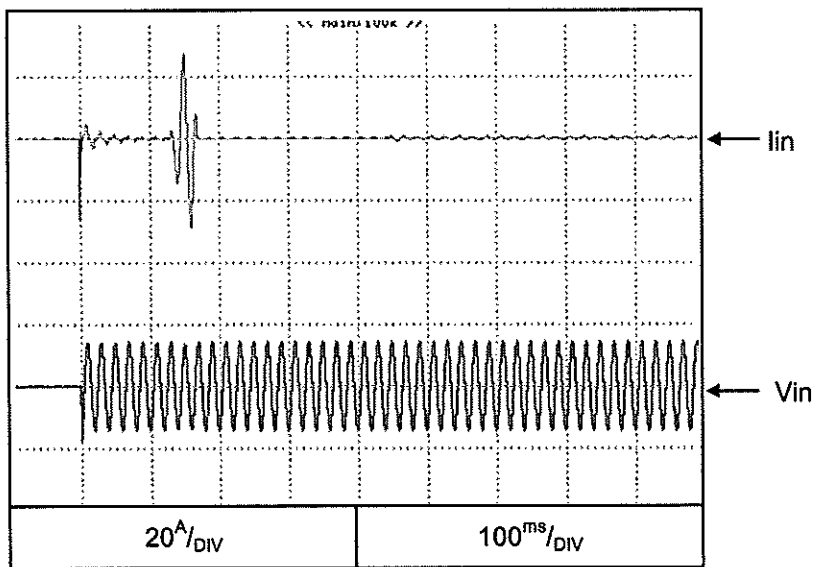

* Inrush current more than 30A is charge current into input film capacitor for EMI. These pulse width is less than 200usec.

2.11 Inrush current waveform

Conditions: Vin: 200V
 Vout: 100%
 Iout: 100%
 Ta = 25°C

Z10-60

Switch on phase angle
 of input AC voltage

$\phi=0^\circ$

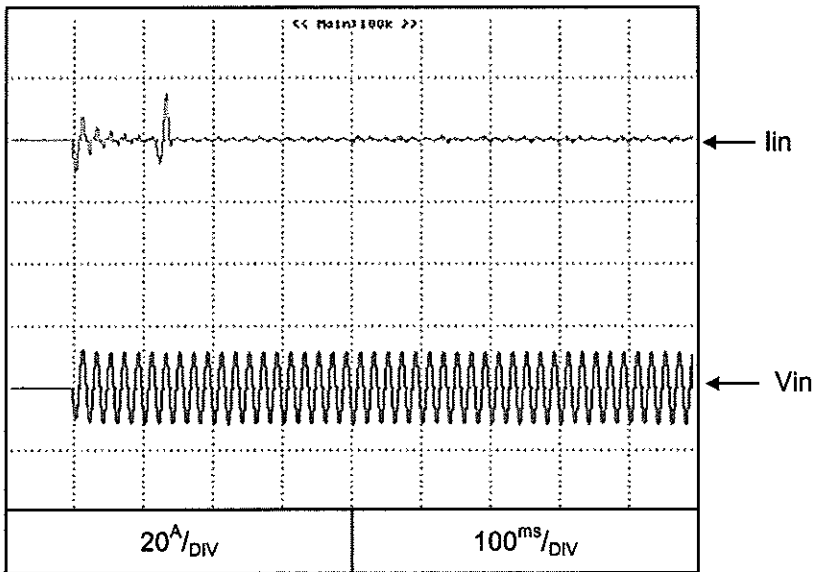

Switch on phase angle
 of input AC voltage

$\phi=90^\circ$

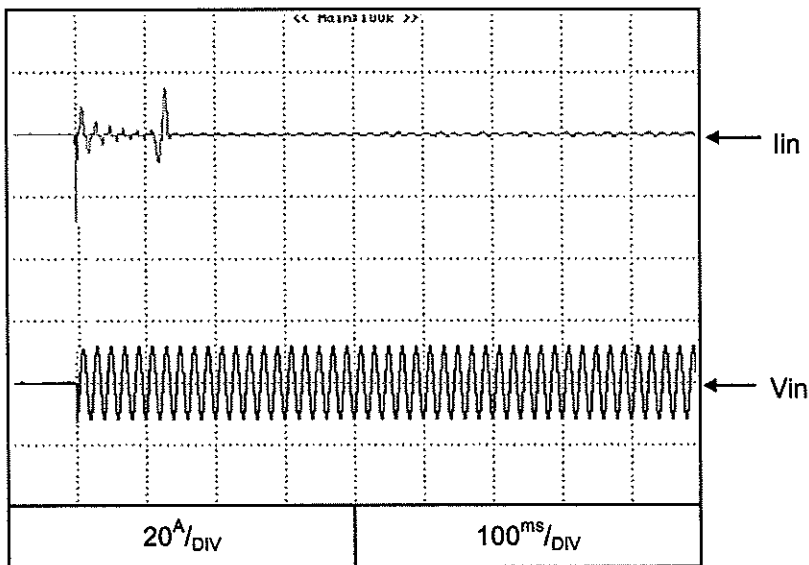

* Inrush current more than 30A is charge current into input film capacitor for EMI. These pulse width is less than 200usec.

2.11 Inrush current waveform

Conditions: Vin: 100V
 Vout: 100%
 Iout: 100%
 Ta = 25°C

Z100-6

Switch on phase angle
 of input AC voltage
 $\phi=0^\circ$

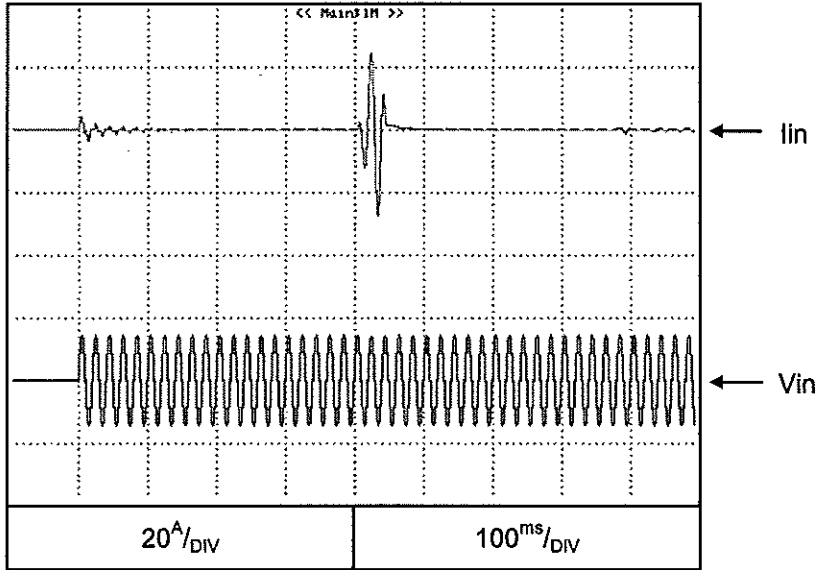

Switch on phase angle
 of input AC voltage
 $\phi=90^\circ$

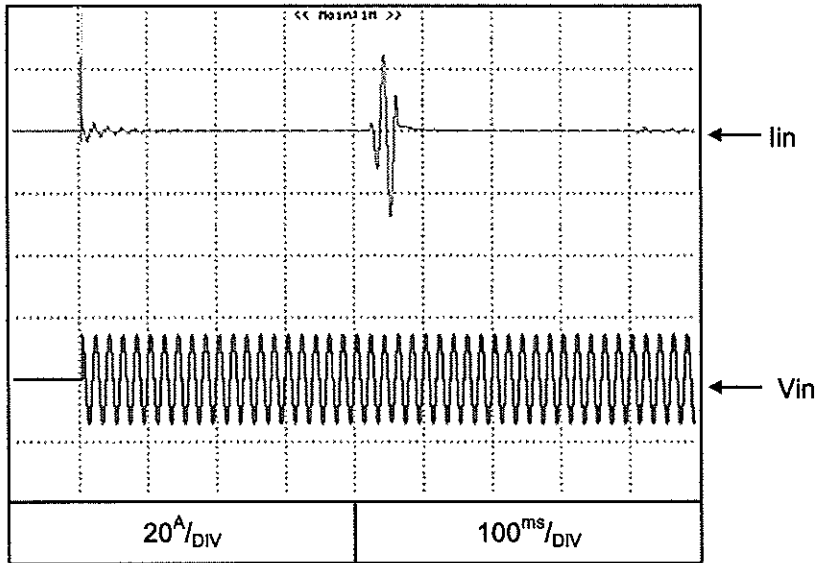

* Inrush current more than 30A is charge current into input film capacitor for EMI. These pulse width is less than 200usec.

2.11 Inrush current waveform

Conditions: Vin: 200V
Vout: 100%
Iout: 100%
Ta = 25°C

Z100-6

Switch on phase angle
of input AC voltage

$\phi=0^\circ$

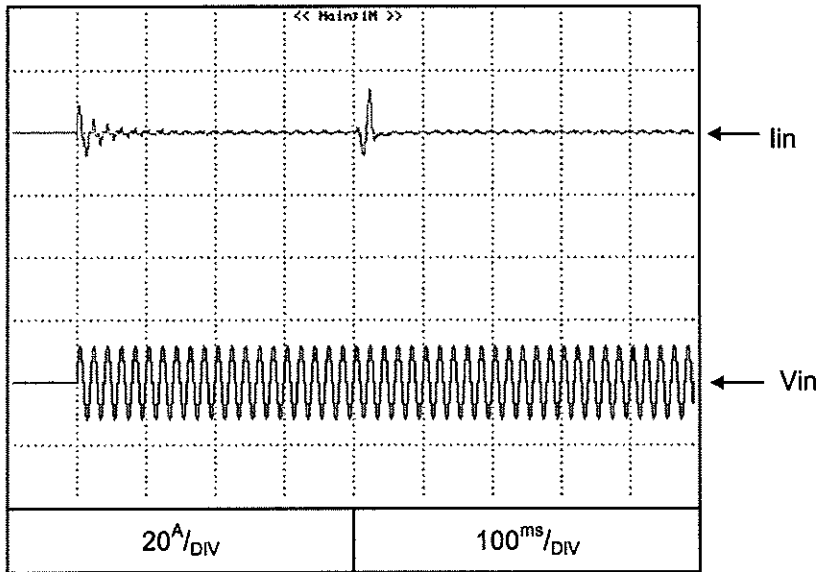

Switch on phase angle
of input AC voltage

$\phi=90^\circ$

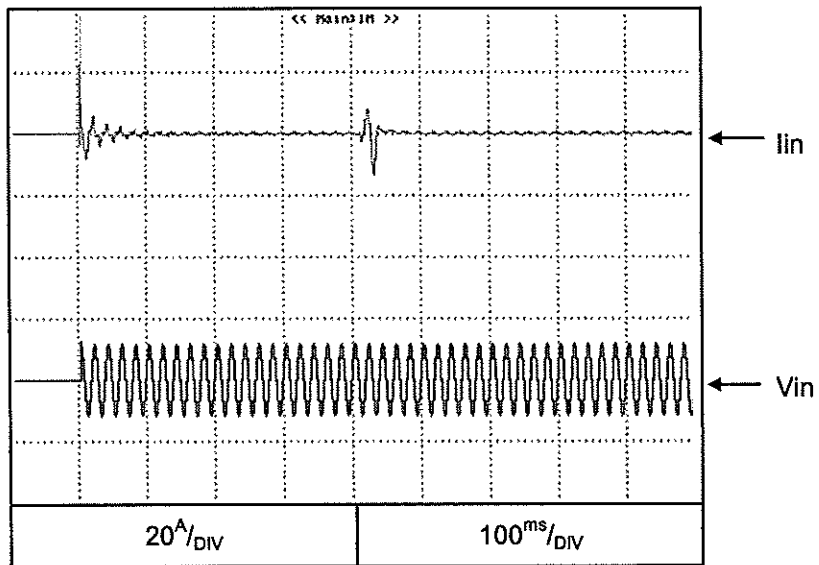

* Inrush current more than 30A is charge current into input film capacitor for EMI.
These pulse width is less than 200usec.

2.12 Input current waveform

Conditions: Vin: 100VAC
Vout: 100%
Iout: 100%
Ta = 25°C

Z10-60

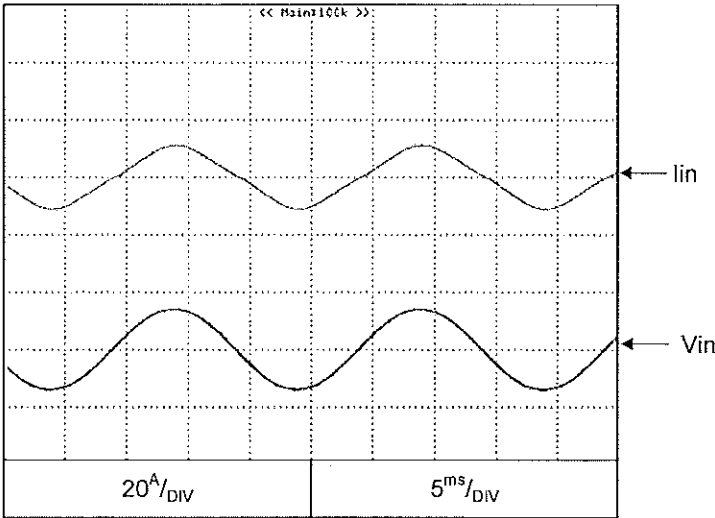

Conditions: Vin: 200VAC
Vout: 100%
Iout: 100%
Ta = 25°C

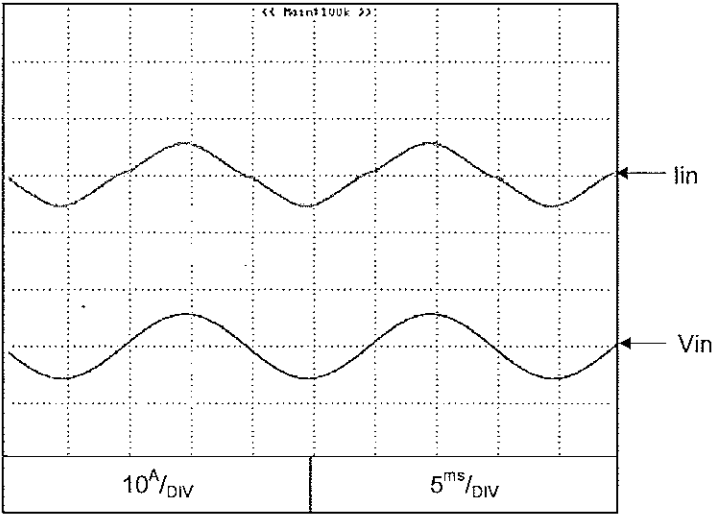

2.12 Input current waveform

Conditions: Vin: 100VAC
Vout: 100%
Iout: 100%
Ta = 25°C

Z100-6

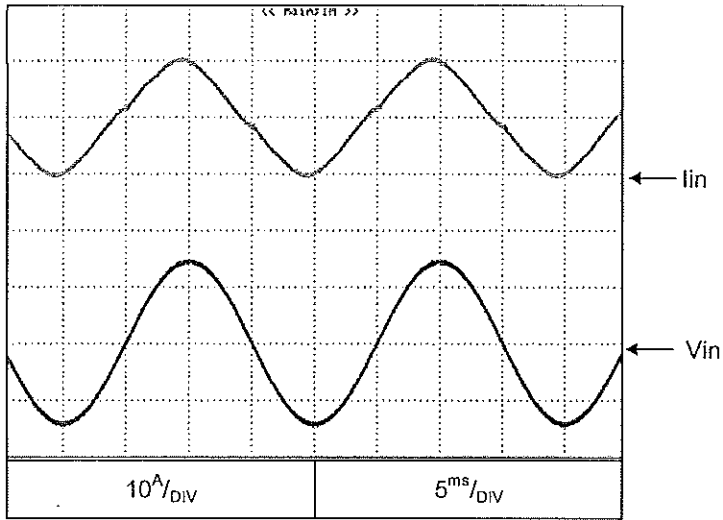

Conditions: Vin: 200VAC
Vout: 100%
Iout: 100%
Ta = 25°C

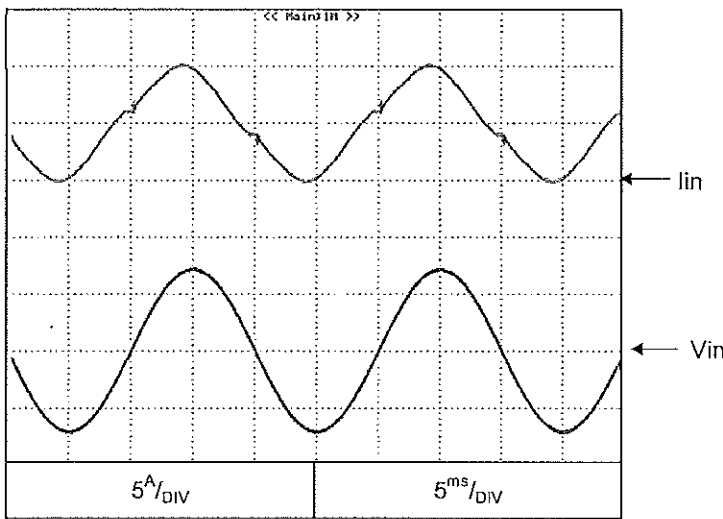

2.13 Leakage current characteristics

Conditions: Vin: 100~265Vac
Iout: 0% - - - - -
Iout: 100% ————
Ta = 25°C
f=50HZ

Z36-18

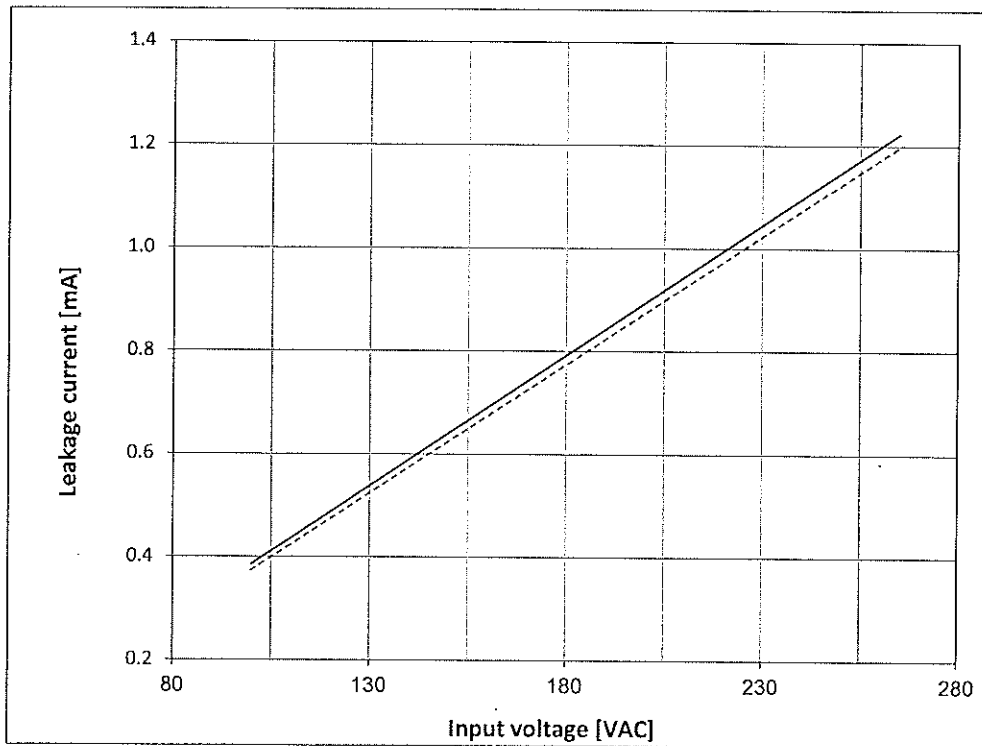

2.14 Output voltage ripple & noise waveform

Conditions: Vin: 100VAC
Vout: 100%
Iout: 100%
Ta = 25°C

C.V mode

Normal Mode

Z10-60

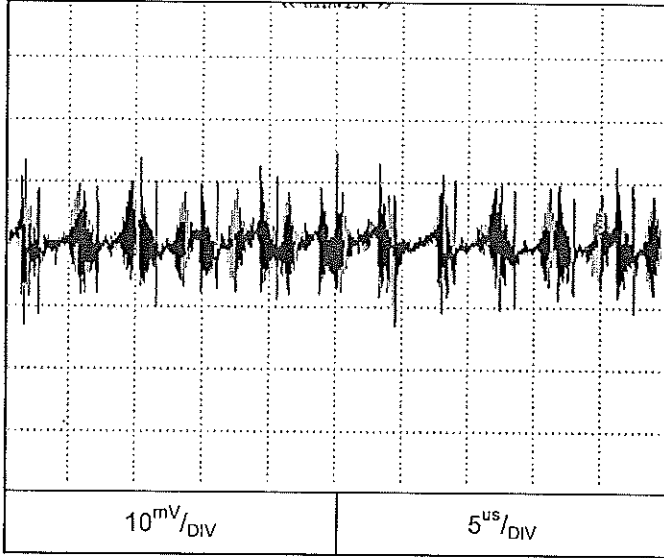

Z36-18

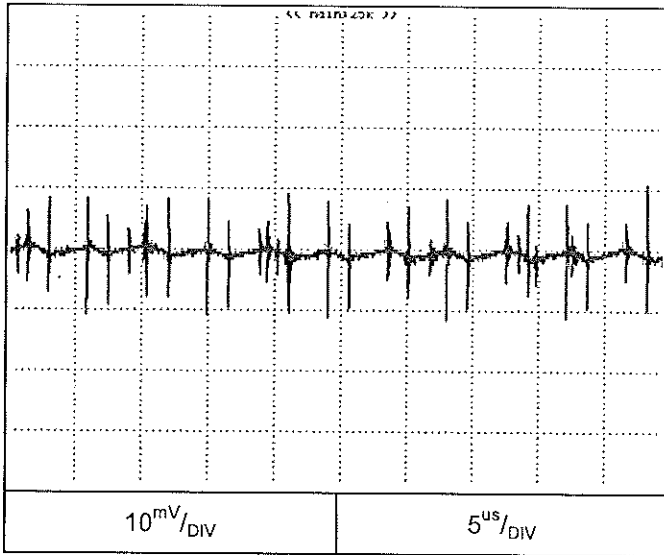

2.14 Output voltage ripple & noise waveform

Conditions: Vin: 100VAC
Vout: 100%
Iout: 100%
Ta = 25°C

C.V mode

Normal Mode

Z100-6

