



Z⁺ 600 H.V Series

EVALUATION

DATA

DWG No.: IA798-53-02		
APPD	CHK	DWG
 2/12/14	 2/12/14	Kami S. Nov-20-14

INDEX**PAGE**

1. EVALUATION METHOD	
1.1 Circuit used for determination	T-1~4
(1) Steady state data	
(2) Warm up voltage drift characteristics	
(3) Warm up current drift characteristics	
(4) Over voltage protection (OVP) characteristics	
(5) Output voltage rise/fall characteristics	
(6) Output current rise/fall characteristics	
(7) Dynamic line voltage and current response characteristics	
(8) Dynamic load voltage and current response characteristics	
(9) Response to brown-out characteristics	
(10) Inrush current characteristics	
(11) Leakage current characteristics	
(12) Output Voltage ripple & noise waveform 160V to 650V models	
(13) Output Current ripple & noise waveform 160V to 650V models	
1.2 List of equipment used	T-5
2. CHARACTERISTICS	
2.1 Steady state data	
(1) Regulation - Line & Load, Temperature drift	T-06~09
(2) Output voltage and ripple voltage v.s input voltage	T-10~11
(3) Output current and ripple current v.s input voltage	
(4) Efficiency and Input current vs. Output current	T-12~13
2.2 Warm up voltage drift & temperature stability	T-14~15
2.3 Over voltage protection (OVP) characteristics	T-16
2.4 ON/OFF Output rise characteristics	T-17~20
2.5 ON/OFF Output fall characteristics	T-21~24
2.6 Hold up time characteristics	T-25~26
2.7 Dynamic line response characteristics	T-27~30
2.8 Dynamic load response characteristics	T-31~33
2.9 Response to brown-out characteristics	T-34~37
2.10 Inrush current characteristics	T-38~39
2.11 Inrush current waveform	T-40~41
2.12 Input current waveform	T-42
2.13 Leakage current characteristics	T-43
2.14 Output voltage ripple & noise waveform	T-44

TERMINOLOGY USED

Definition

V _{in}	Input voltage
V _{out}	Output voltage
I _{in}	Input current
I _{out}	Output current
T _a	Ambient temperature
f	Frequency
C.V	Constant voltage mode
C.C	Constant current mode

1. EVALUATION METHOD

1.1 Circuit used for determination

(1) Steady state data

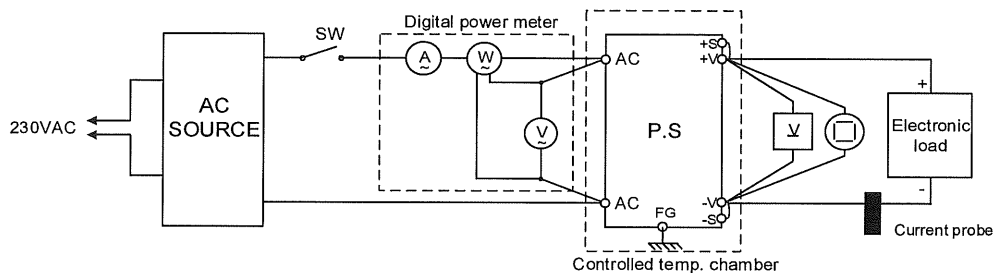

(2) Warm up voltage drift characteristics same as Steady state data

(3) Warm up current drift characteristics same as Steady state data

(4) Over voltage protection (OVP) characteristics

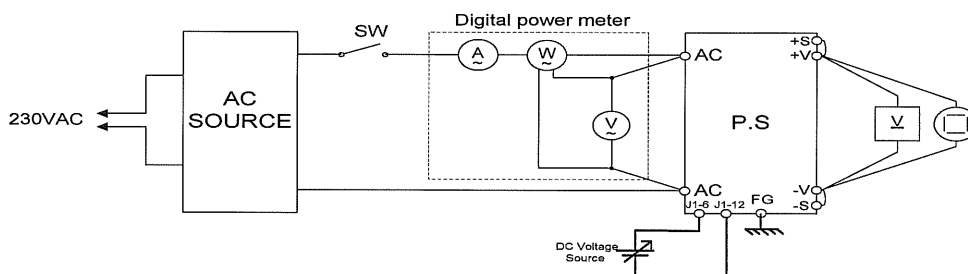

(5) Output voltage rise/fall characteristics same as Steady state data

(6) Output current rise/fall characteristics

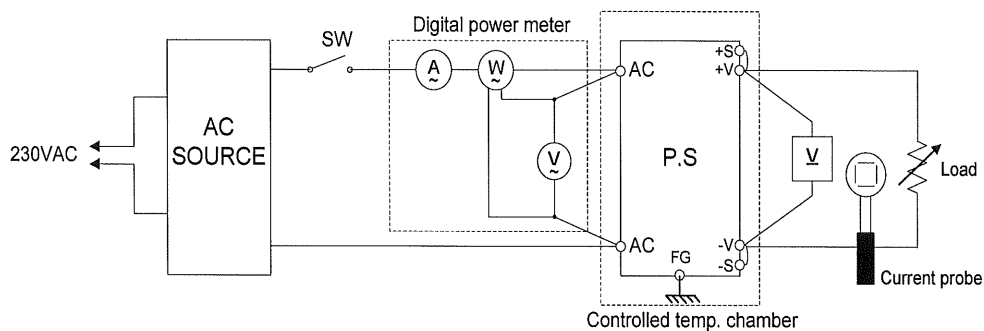

1.1 Circuit used for determination

(7) Dynamic line voltage and current response characteristics

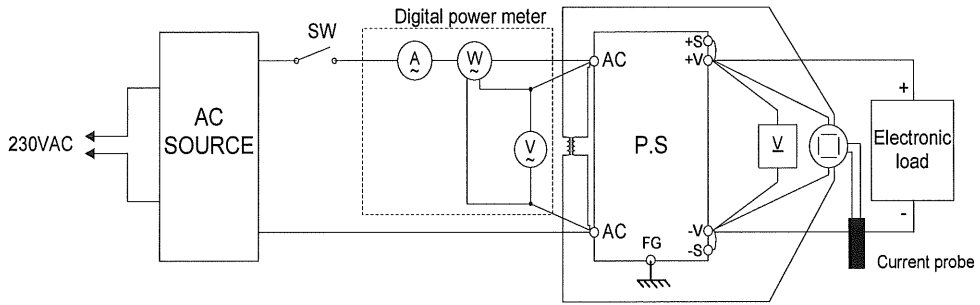

(8) Dynamic load voltage and current response characteristics

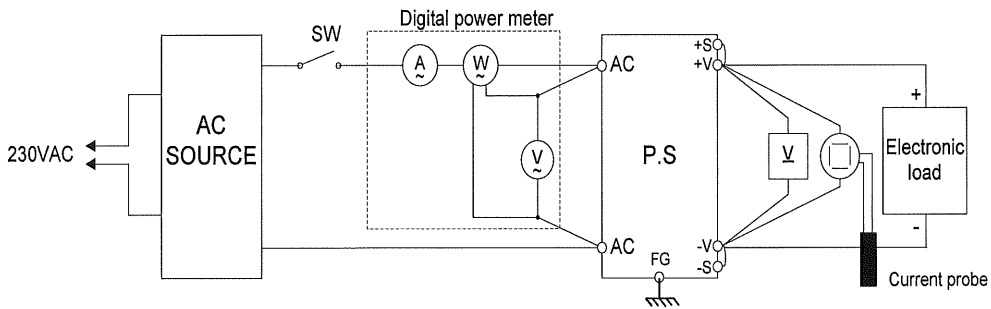

Constant Voltage mode

Output current waveform
I_{out} 0% <---> 100%

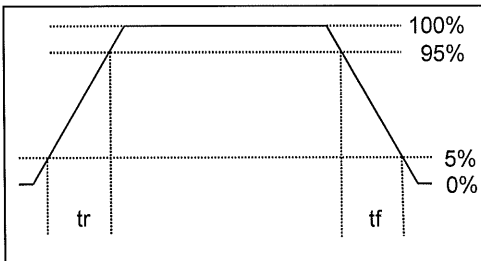

Output current waveform
I_{out} 50% <---> 100%

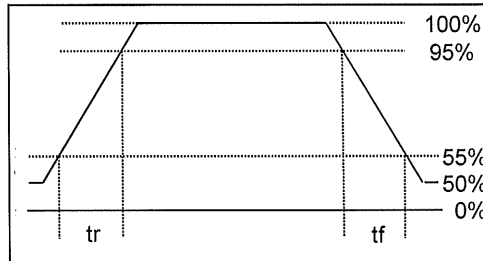

1.1 Circuit used for determination

(9) Response to brown-out characteristics

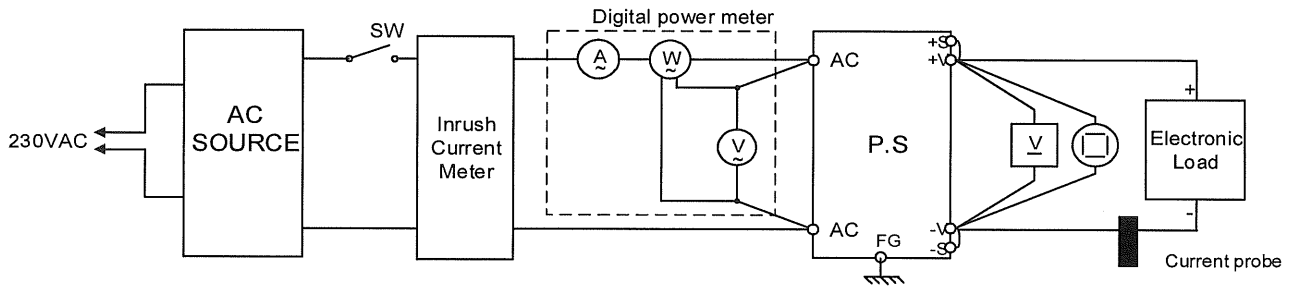

(10) Inrush current characteristics same as Response to brown-out

(11) Leakage current characteristics

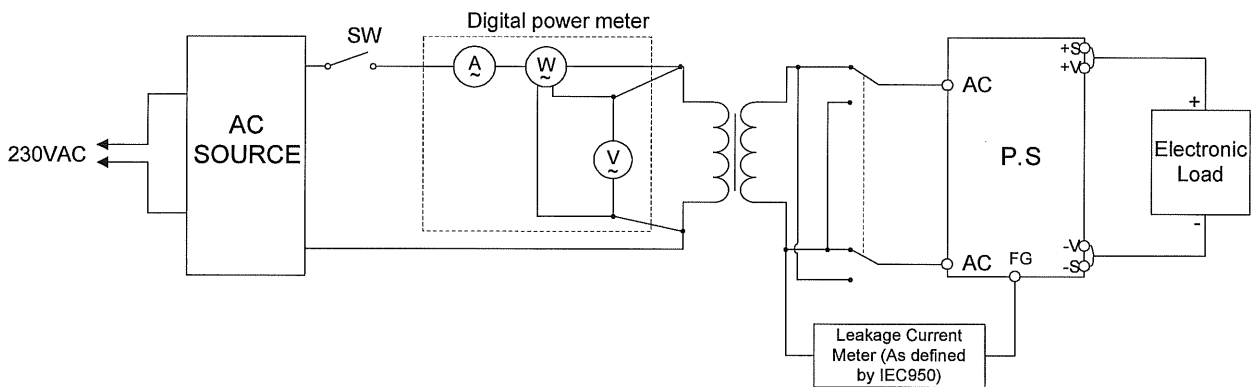

(12) Output Voltage ripple & noise waveform 160V up to 650V models

(a) Normal mode (JEITA Standard RC-9131A)

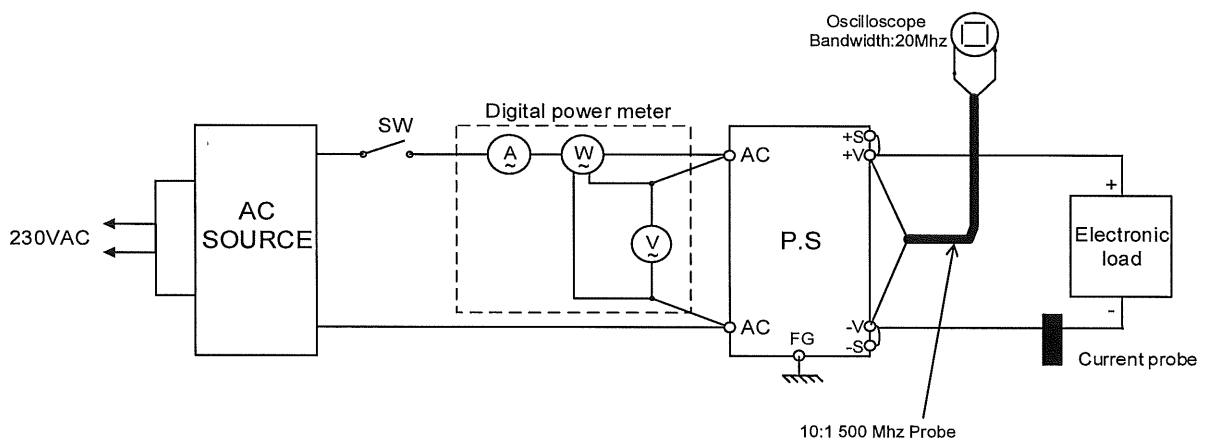

1.1 Circuit used for determination

(12) Output Voltage ripple & noise waveform 160V up to 650V models

(b) Normal + Common mode

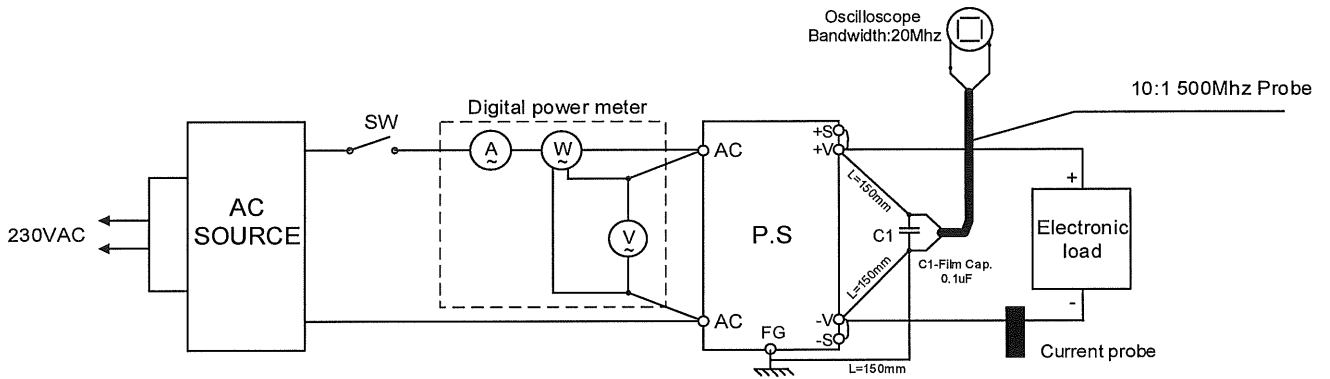

(13) Output Current rms ripple 160V to 650V models

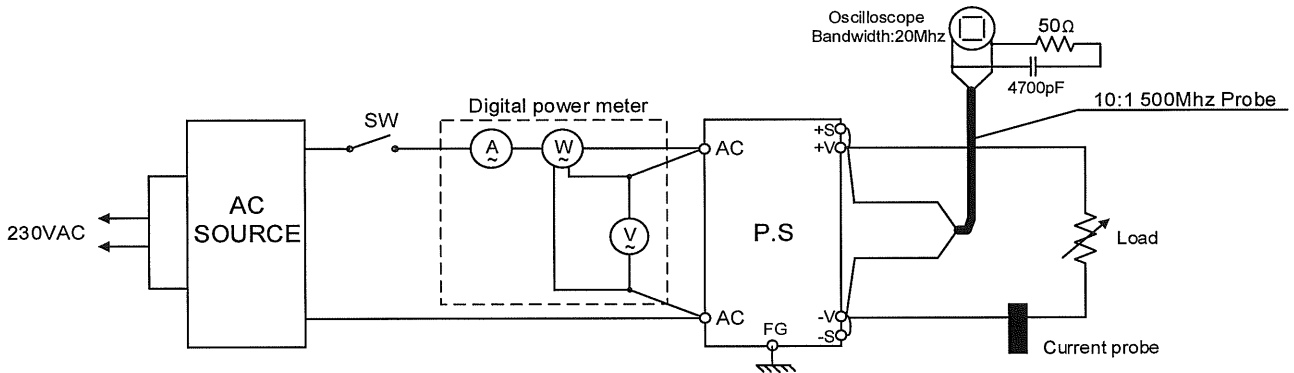

Notes:

(*) Output Current rms ripple = Output Voltage rms ripple divided by the Load resistance.

1.2 List of equipment used

	EQUIPMENT USED	MANUFACTURER	MODEL No.
1	Digital oscilloscope	YOKOGAWA	DL1740 E/EL
2	Digital multimeter	AGILENT	34401A
3	Digital power meter	YOKOGAWA	WT230 / WT110
4	AC source	CHROMA	6590/6463/6520/6530
5	Electronic load	H&H	ZS1880/ZS7060/ZS4260
6	Electronic load	CHROMA	63202 / 63204
7	Resistor load	ARCOL	HS100
8	Leakage current tester	KIKUSUI	TOS3200
9	Voltage probe	YOKOGAWA	701939/701944
10	Current probe	YOKOGAWA	701933
11	Inrush Current Meter	TAKAMISAWA	PSA-210
12	Data acquisition / switch unit	AGILENT	34970A
13	Controlled temp. chamber	THERMOTRON	SM-16-3800
14	Controlled temp. chamber	THERMOTRON	SM-16-8200
15	Controlled temp. chamber	THERMOTRON	SE-600-5-5
16	Controlled temp. chamber	THERMOTRON	SE-600-6-6

2. CHARACTERISTIC

2.1 Steady state data

(1) Regulation - Line & Load, Temperature drift

Z160-4

Conditions: Ta = 25°C

1. Regulation - Line & Load, C.V mode (Readings in [V])

Io	Vin (AC)				Line Regulation	
	85	100	200	265		
0%	159.9521	159.9518	159.9516	159.9514	0.7	0.000
25%	159.9514	159.9520	159.9520	159.9519	0.6	0.000
50%	159.9523	159.9520	159.9525	159.9524	0.5	0.000
75%	159.9525	159.9526	159.9524	159.9522	0.4	0.000
100%	159.9527	159.9528	159.9529	159.9531	0.4	0.000
Load	1.3	1.0	1.3	1.7	$\Delta V(mV)$	(%)
Regulation	0.001	0.001	0.001	0.001	(%)	

2. Temperature drift, C.V mode

Conditions: Vin:100Vac
Iout:100%

Ta	0°C	25°C	50°C	Temp. Coefficient (0°C~50°C)	
Vout	159.989	159.973	159.978	16 mV	1.4 ppm/°C

2.1 Steady state data

(1) Regulation - Line & Load, Temperature drift

Z650-1

Conditions: Ta = 25°C

1. Regulation - Line & Load, C.V mode (Readings in [V])

Io	Vin (AC)				Line Regulation	
	85	100	200	265		
0%	649.9323	649.9320	649.9316	649.9303	2.0	0.000
25%	649.9310	649.9311	649.9309	649.9309	0.2	0.000
50%	649.9305	649.9312	649.9304	649.9301	1.1	0.000
75%	649.9307	649.9293	649.9289	649.9287	2.0	0.000
100%	649.9286	649.9281	649.9279	649.9274	1.2	0.000
Load Regulation	3.7	3.9	3.7	3.5	$\Delta V(mV)$	(%)
	0.001	0.001	0.001	0.001	(%)	

2. Temperature drift, C.V mode

Conditions: Vin:100Vac
Iout:100%

Ta	0°C	25°C	50°C	Temp. Coefficient (0°C~50°C)	
Vout	650.029	650.022	650.140	118 mV	3.4 ppm/°C

2.1 Steady state data

(1) Regulation - Line & Load, Temperature drift

Z160-4

Conditions: Ta = 25°C

1. Regulation - Line & Load, C.C mode (*) (Readings in [A])

Vo	Vin (AC)				Line Regulation	
	85	100	200	265		
0%	4.0003	4.0003	4.0003	4.0003	0.0	0.000
25%	4.0001	4.0001	4.0001	4.0001	0.0	0.000
50%	3.9999	3.9999	3.9998	3.9998	0.1	0.003
75%	3.9996	3.9996	3.9996	3.9996	0.0	0.000
100%	3.9994	3.9994	3.9993	3.9993	0.1	0.003
Load Regulation	0.9	0.9	1.0	1.0	ΔI (mA)	(%)
	0.022	0.022	0.025	0.025	(%)	

Notes:

(*) Not including load regulation thermal drift effect.

2. Temperature drift, C.C mode

Conditions: Vin:100Vac
Iout:100%

Ta	0°C	25°C	50°C	Temp. Coefficient (0°C~50°C)	
Iout	3.99929	3.99909	3.99995	0.7 mA	3.3 ppm/°C

2.1 Steady state data

(1) Regulation - Line & Load, Temperature drift

Z650-1

Conditions: Ta = 25°C

1. Regulation - Line & Load, C.C mode (*) (Readings in [A])

Vo	Vin (AC)				Line Regulation	
	85	100	200	265		
0%	1.0002	1.0002	1.0002	1.0002	0.0	0.000
25%	1.0004	1.0004	1.0004	1.0004	0.0	0.000
50%	1.0003	1.0003	1.0003	1.0003	0.0	0.000
75%	1.0003	1.0003	1.0003	1.0003	0.0	0.000
100%	1.0002	1.0002	1.0002	1.0002	0.0	0.000
Load Regulation	0.2	0.2	0.2	0.2	$\Delta I(\text{mA})$	(%)
	0.020	0.020	0.020	0.020	(%)	

Notes:

(*) Not including load regulation thermal drift effect.

2. Temperature drift, C.C mode

Conditions: Vin:100Vac
Iout:100%

Ta	0°C	25°C	50°C	Temp. Coefficient (0°C~50°C)	
Iout	1.00005	0.99978	1.00020	0.1 mA	3 ppm/°C

2.1 Steady state data

(2) Output voltage and ripple voltage v.s input voltage

C.V mode

Conditions: I_{out}:100%

Z160-4

Ta: 0°C -----
 25°C - - - - -
 50°C _____

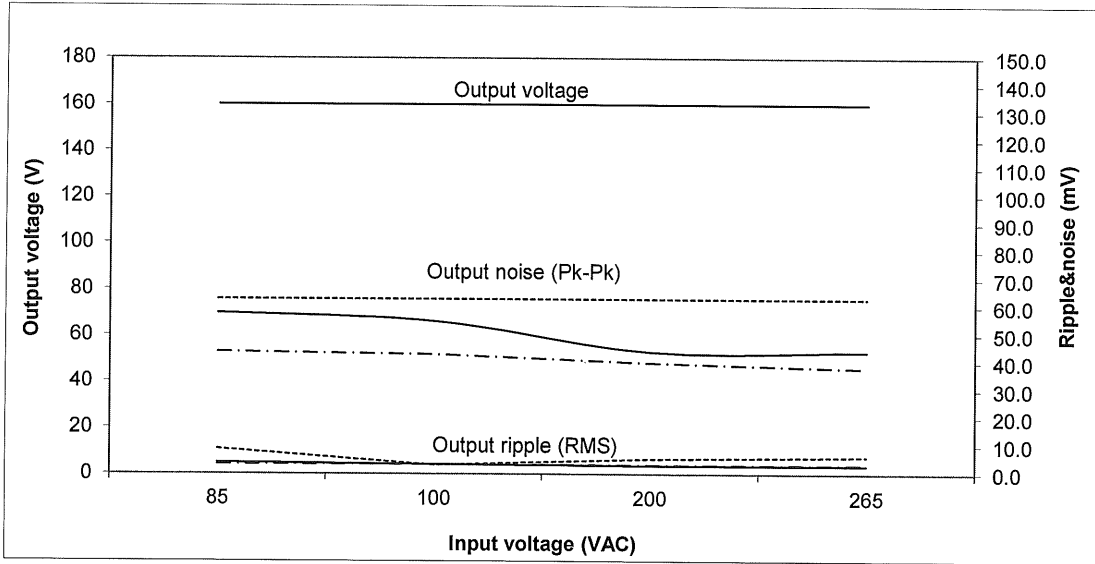

(3) Output current and ripple current v.s input voltage

C.C mode

Conditions: V_{out}:100%

Z160-4

Ta: 0°C -----
 25°C - - - - -
 50°C _____

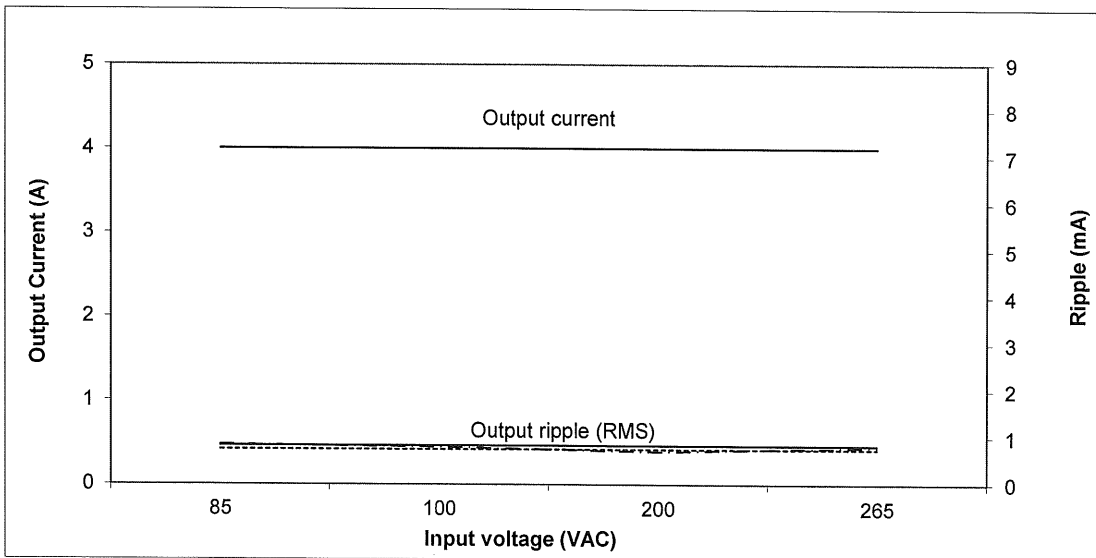

2.1 Steady state data

(2) Output voltage and ripple voltage v.s input voltage

C.V mode

Conditions: Iout:100%

Z650-1

Ta: 0°C -----
 25°C -.-.-.-.-
 50°C _____

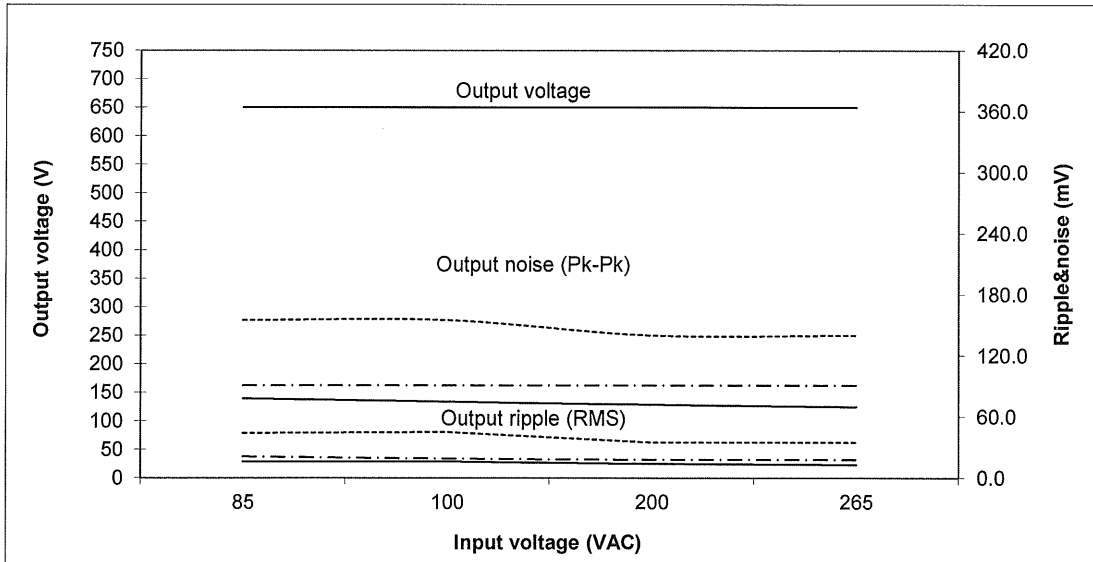

(3) Output current and ripple current v.s input voltage

C.C mode

Conditions: Vout:100%

Z650-1

Ta: 0°C -----
 25°C -.-.-.-.-
 50°C _____

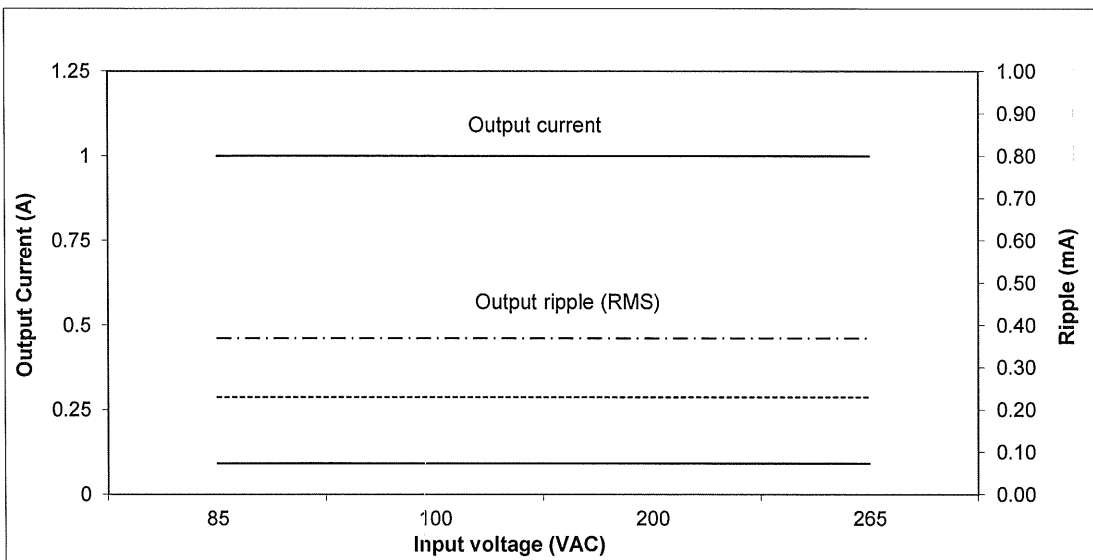

2.2 Warm up drift & stability

Conditions: Vin:100Vac
Vout: 100%
Iout: 100%
Ta = 25°C

C.V mode

Z160-4

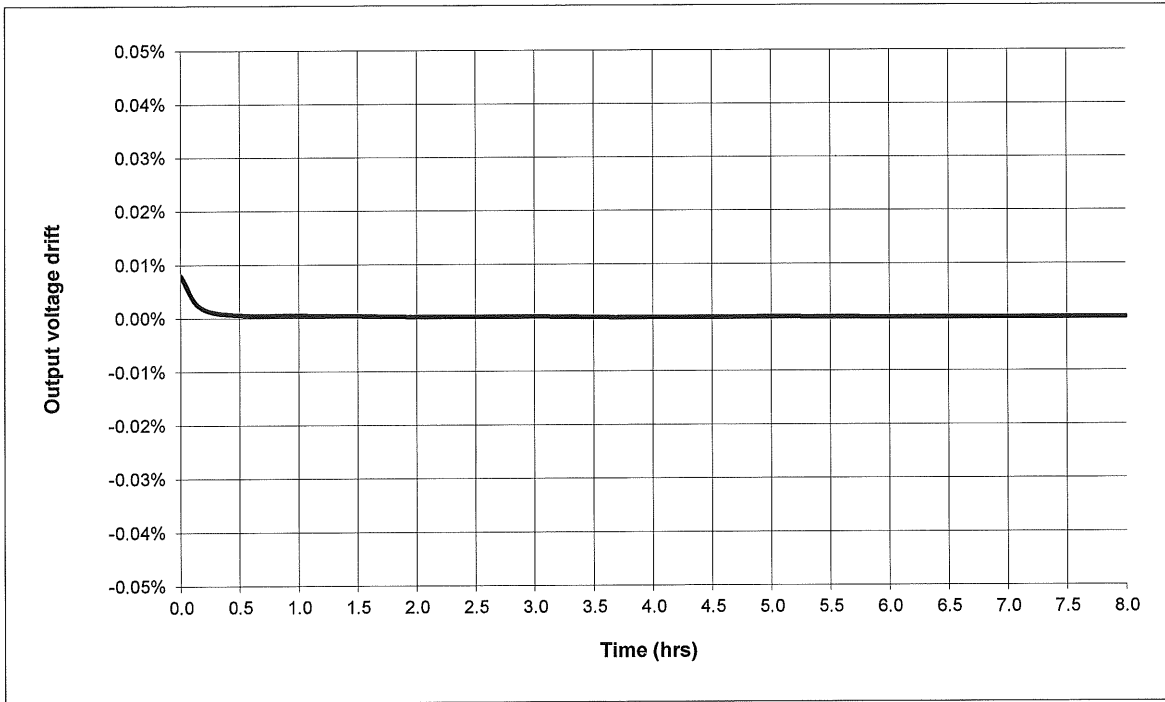

C.C mode

Z160-4

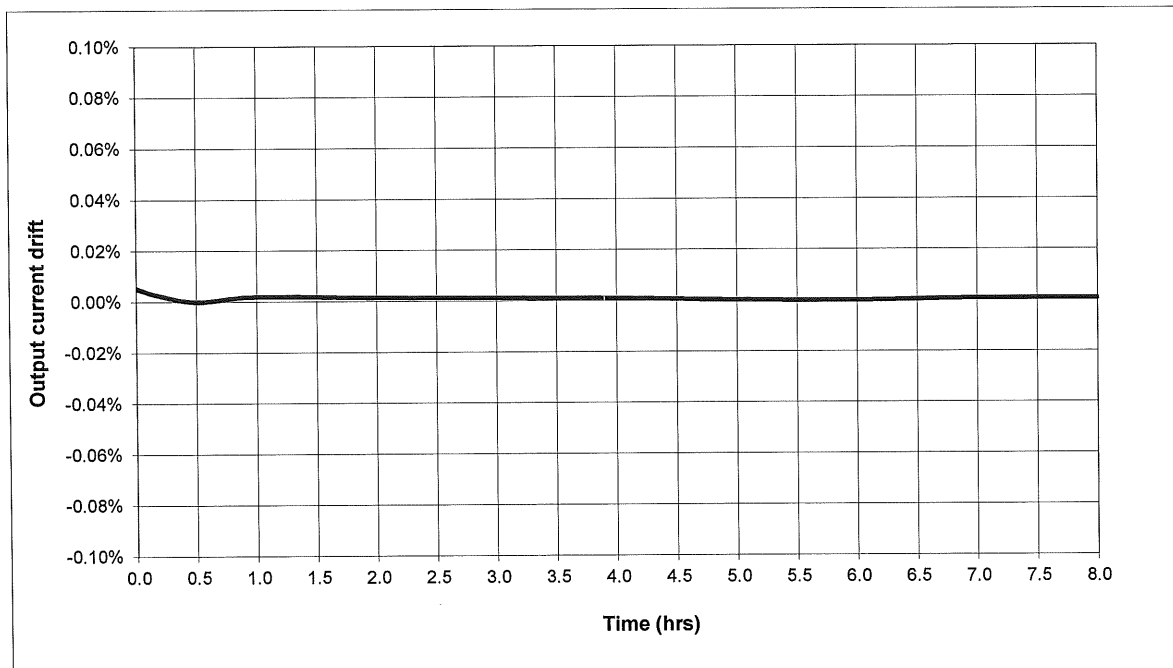

2.2 Warm up drift & stability

Conditions: Vin:100Vac
Vout: 100%
Iout: 100%
Ta = 25°C

C.V mode

Z650-1

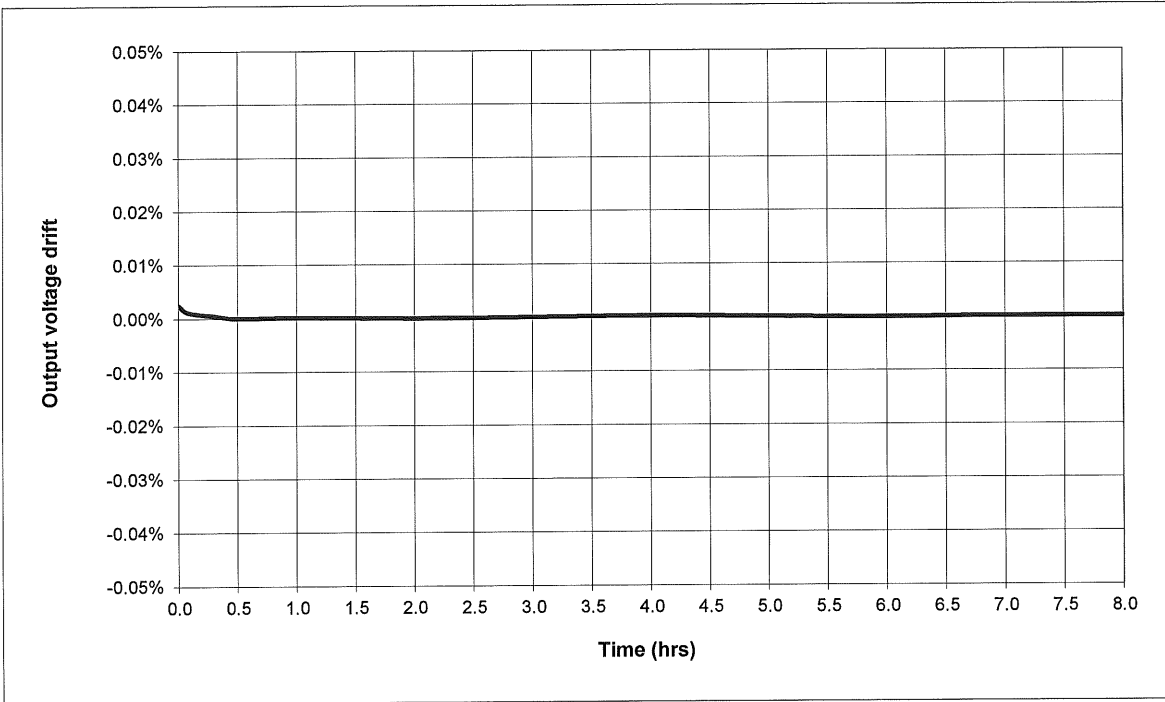

C.C mode

Z650-1

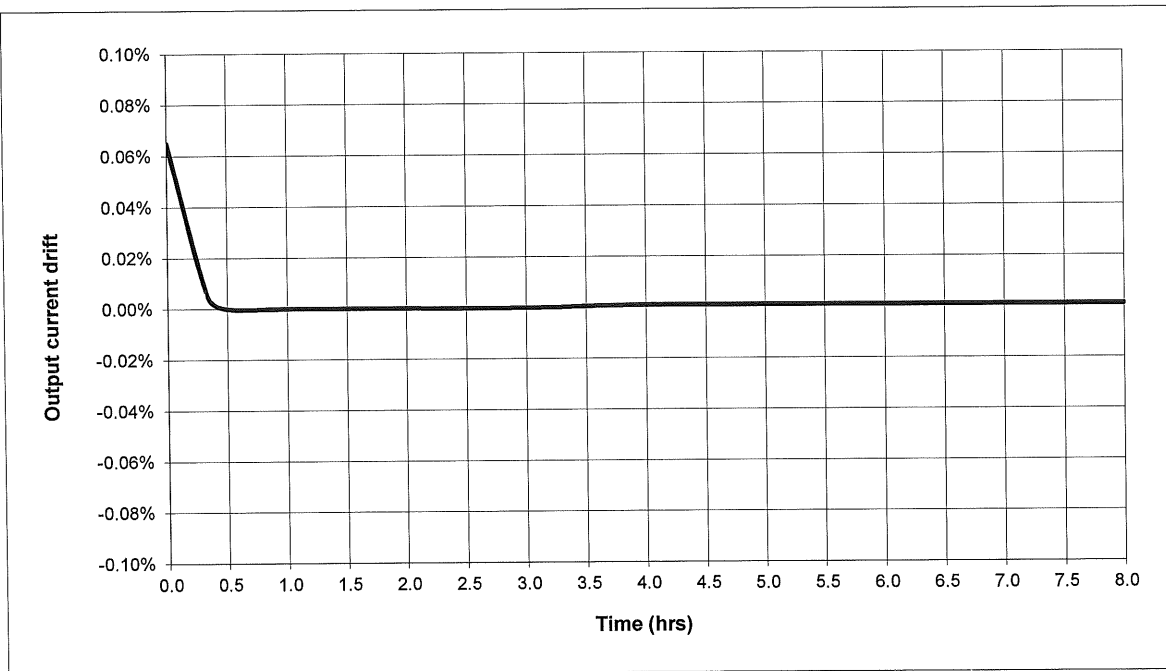

2.3 Over voltage protection characteristics

Conditions:

V_{in}: 100Vac

I_{out}: 0%

T_a = 25°C

Z160-4

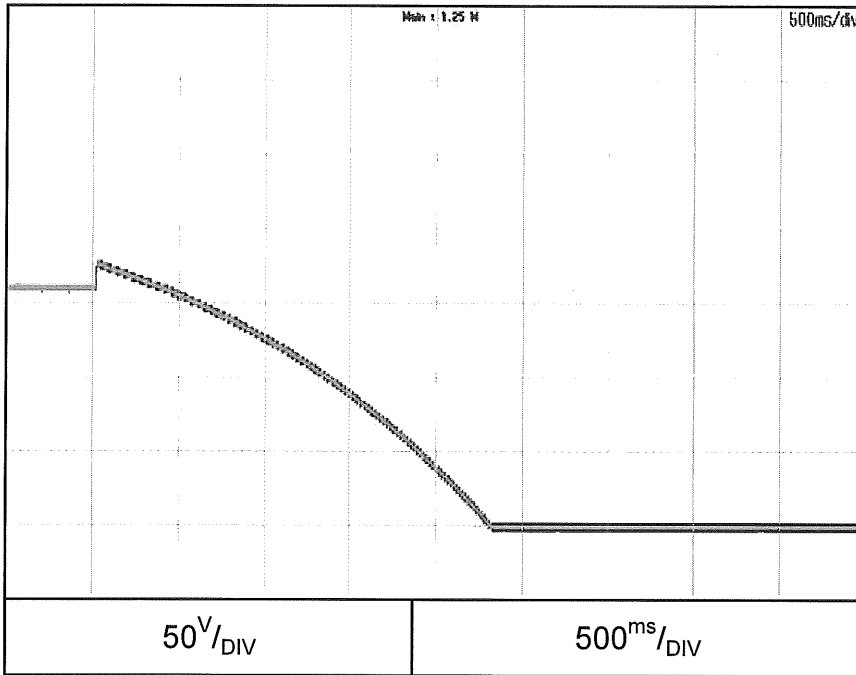

OVP setting: 176V

Z650-1

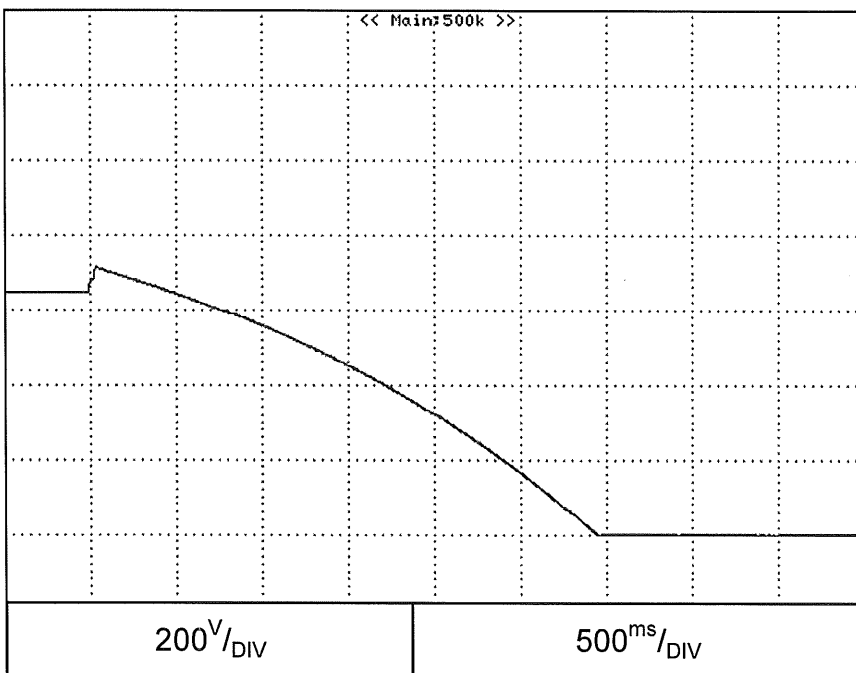

OVP setting: 717V

2.4 ON/OFF Output rise characteristics

Conditions:

V_{in}: 100Vac

V_{out}: 100%

I_{out}: 0%

I_{set} = 105%

T_a = 25°C

C.V mode

Z160-4

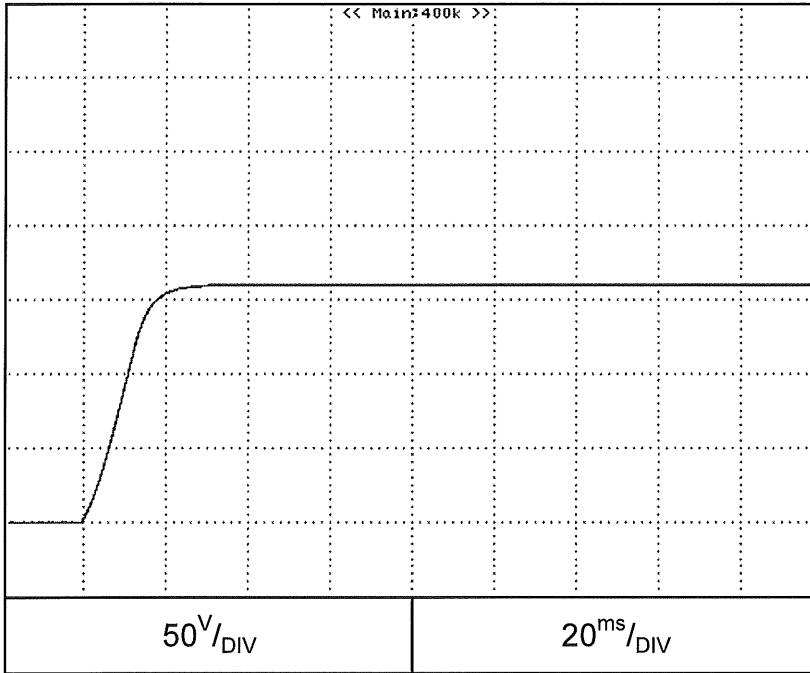

Z650-1

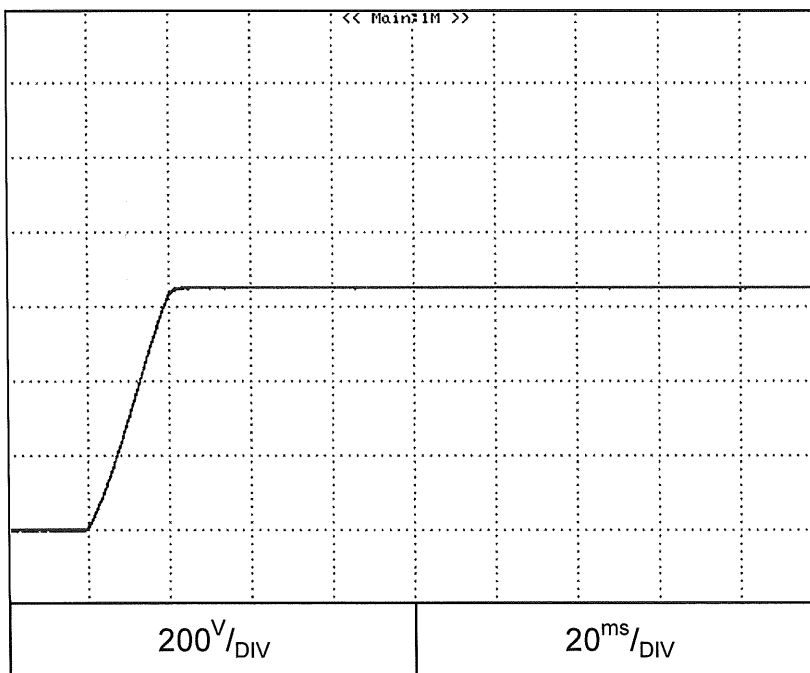

2.4 ON/OFF Output rise characteristics

Conditions:

Vin: 100Vac
Vout: 100%
Iout: 100%
Iset=105%
Load: CR
Ta = 25°C

C.V mode

Z160-4

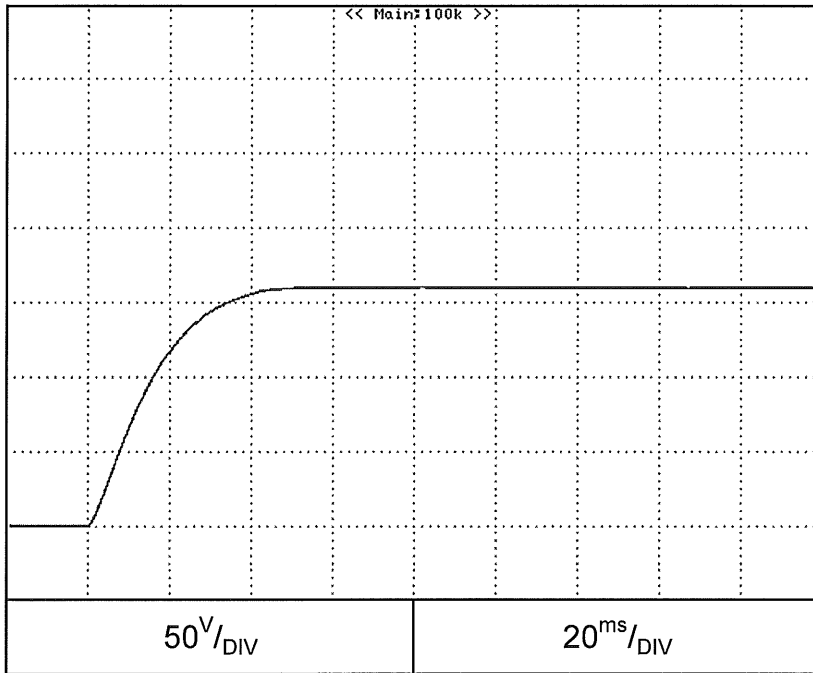

Z650-1

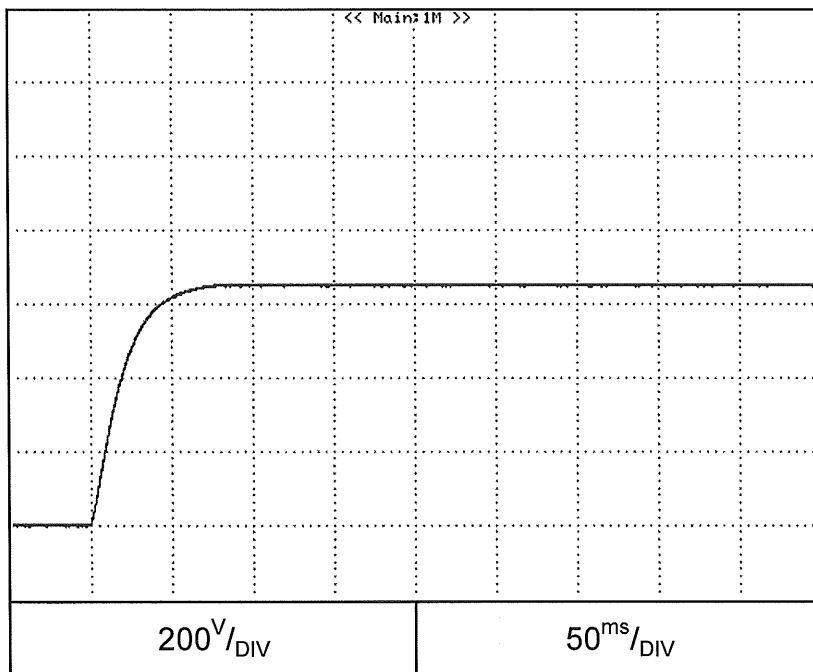

2.4 ON/OFF Output rise characteristics

Conditions:

Vin: 100Vac
Vout: 100%
Iout: 100%
Vset=105%
Load: CR
Ta = 25°C

C.C mode

Z160-4

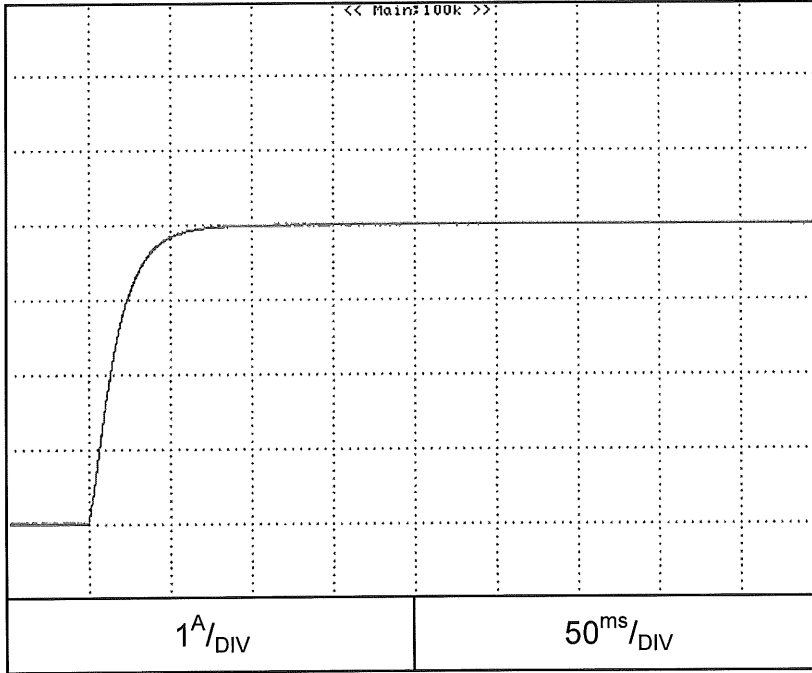

Z650-1

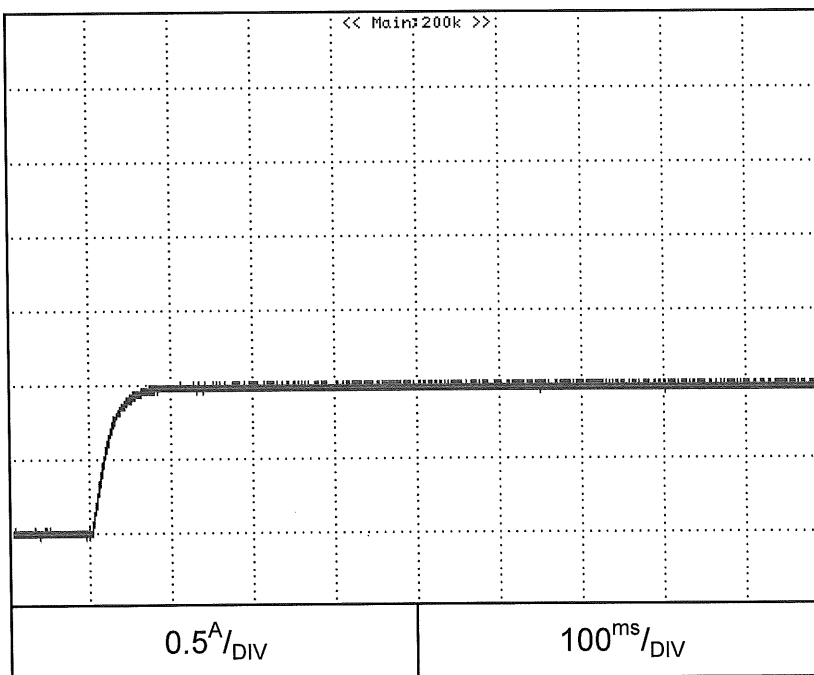

2.4 ON/OFF Output rise characteristics

Conditions:

V_{in}:100Vac
I_{out}: 100%
V_{set}=105%
shorted output
T_a = 25°C

C.C mode

Z160-4

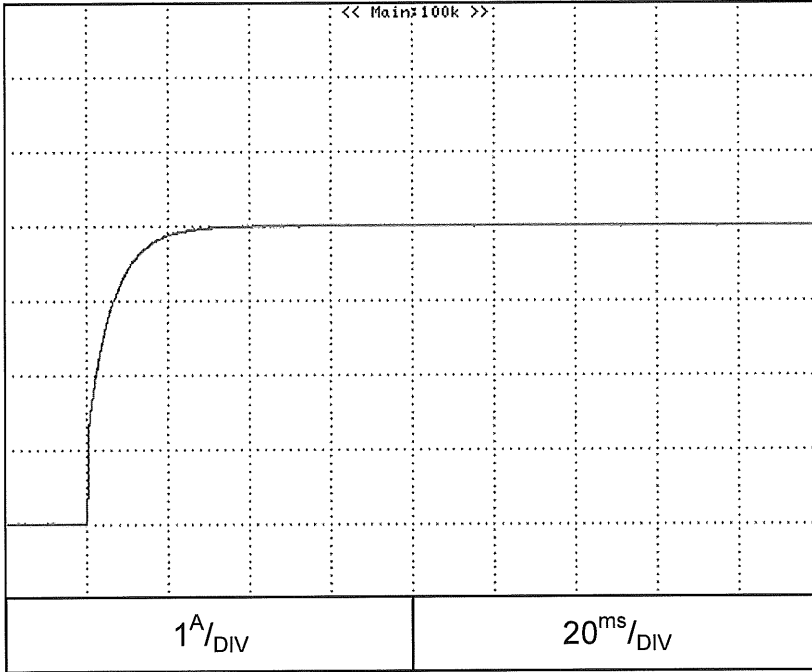

Z650-1

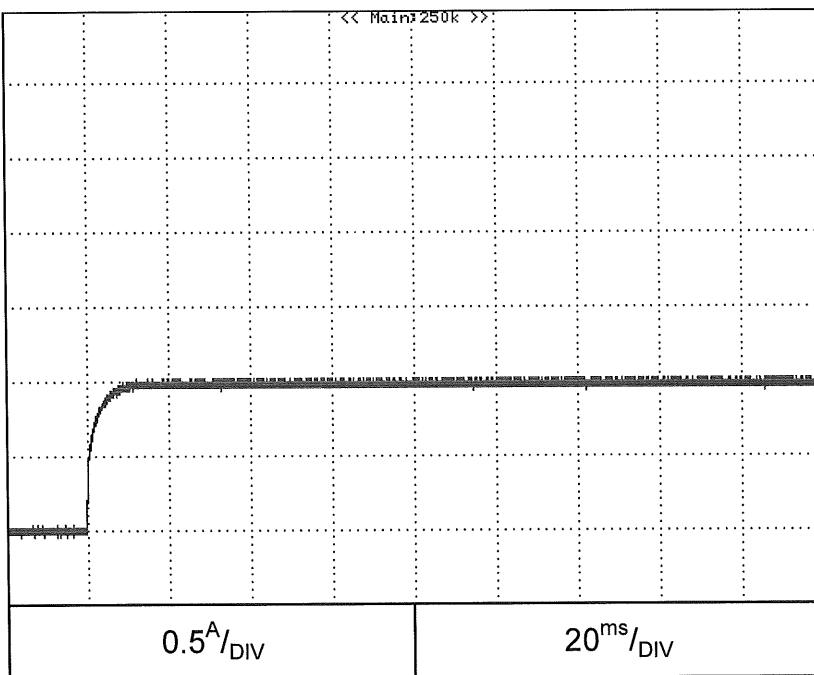

2.5 ON/OFF Output fall characteristics

Conditions:

V_{in}: 100Vac

V_{out}: 100%

I_{out}: 0%

I_{set}: 105%

T_a = 25°C

C.V mode

Z160-4

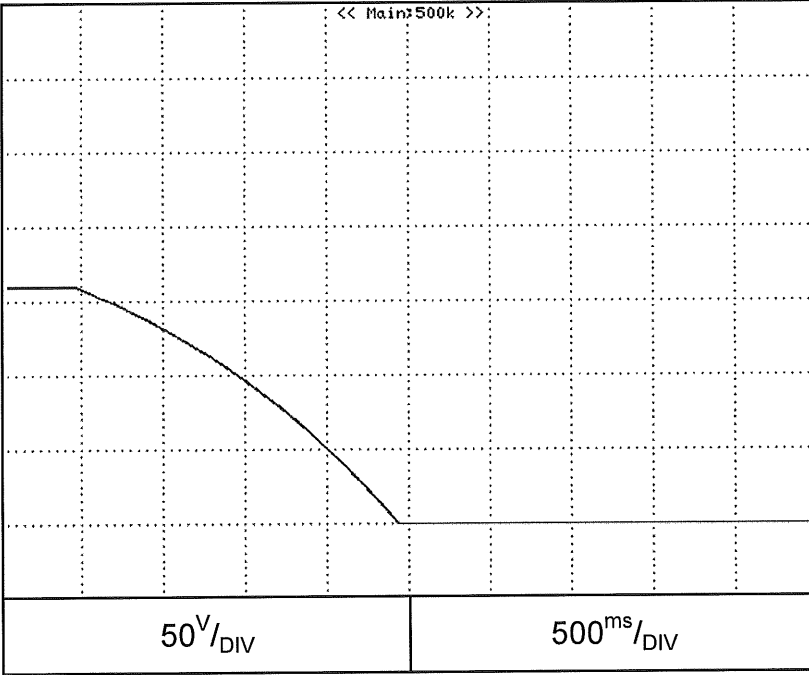

Z650-1

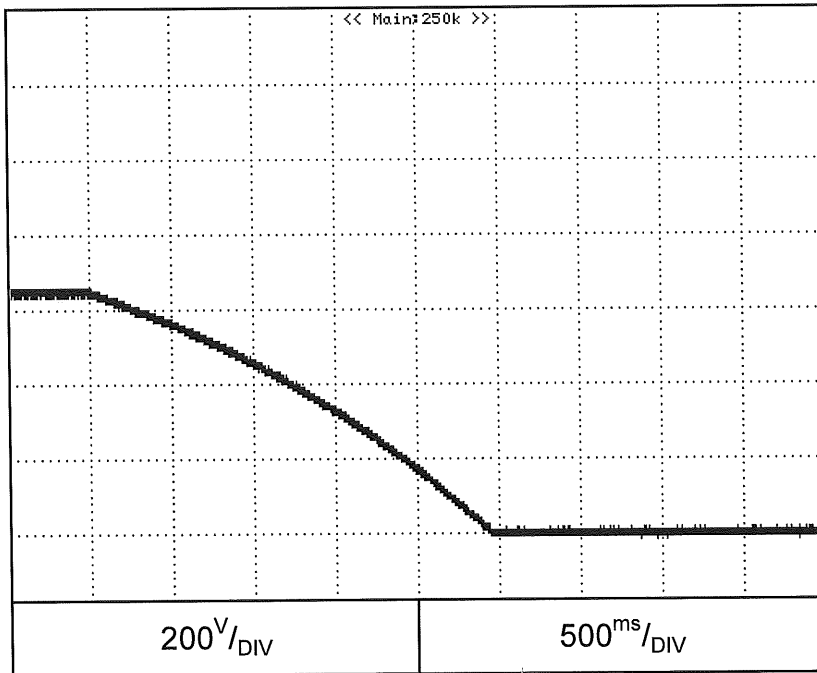

2.5 ON/OFF Output fall characteristics

Conditions: Vin: 100Vac
Vout: 100%
Iout: 100%
Iset=105%
Load: CR
Ta = 25°C

C.V mode

Z160-4

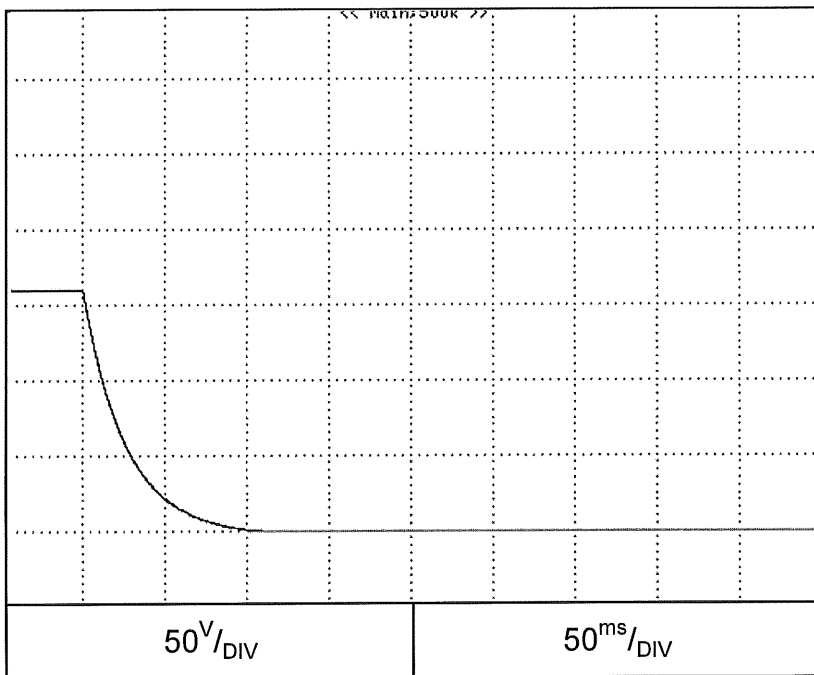

Z650-1

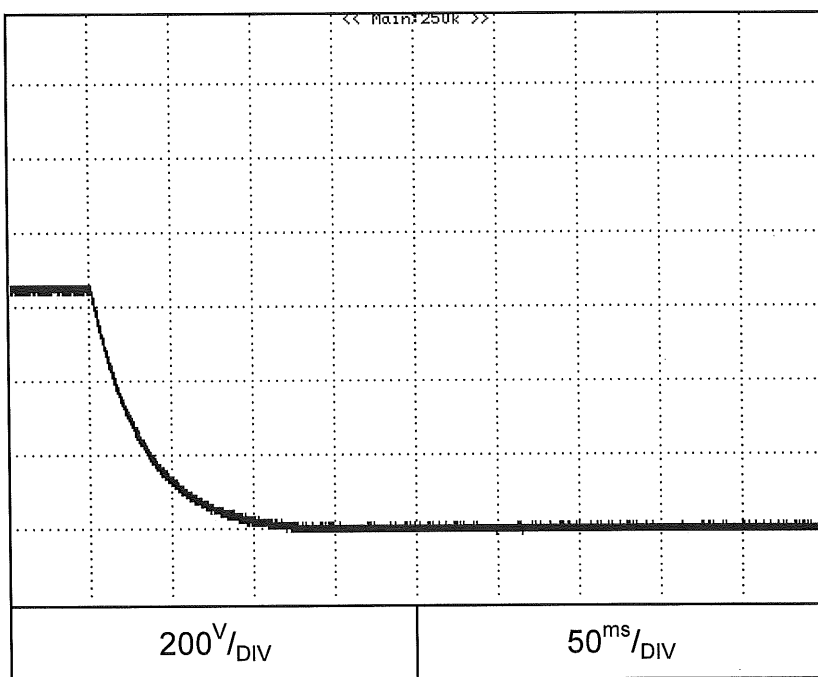

2.5 ON/OFF Output fall characteristics

Conditions:

Vin: 100Vac
Vout: 100%
Iout: 100%
Vset=105%
Load: CR
Ta = 25°C

C.C mode

Z160-4

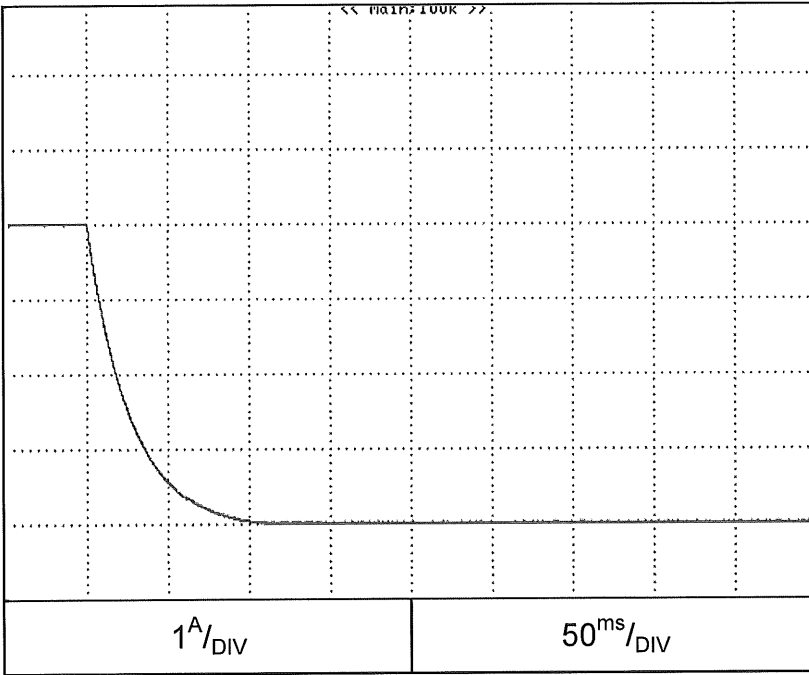

Z650-1

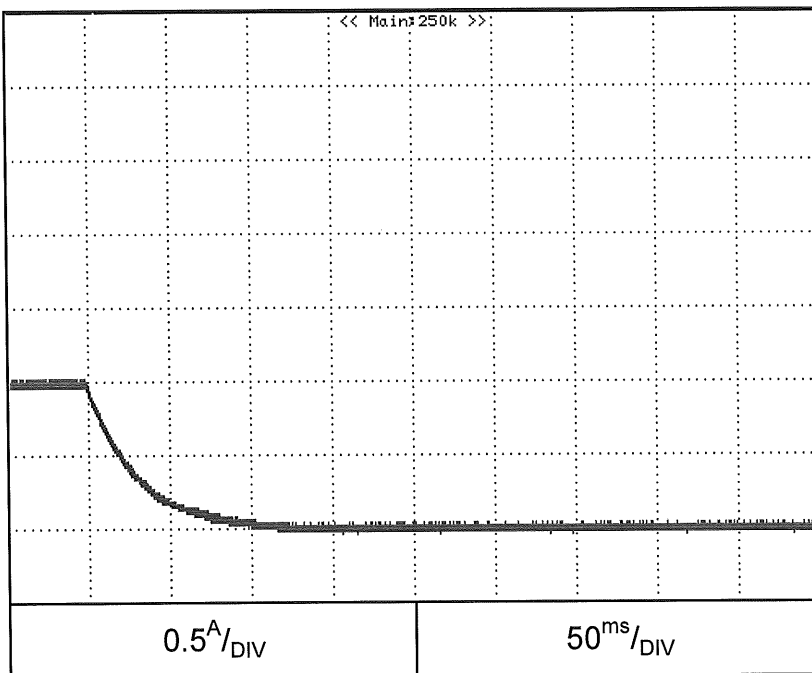

2.5 ON/OFF Output fall characteristics

Conditions:

Vin: 100Vac
Iout: 100%
Vset=105%
shorted output
Ta = 25°C

C.C mode

Z160-4

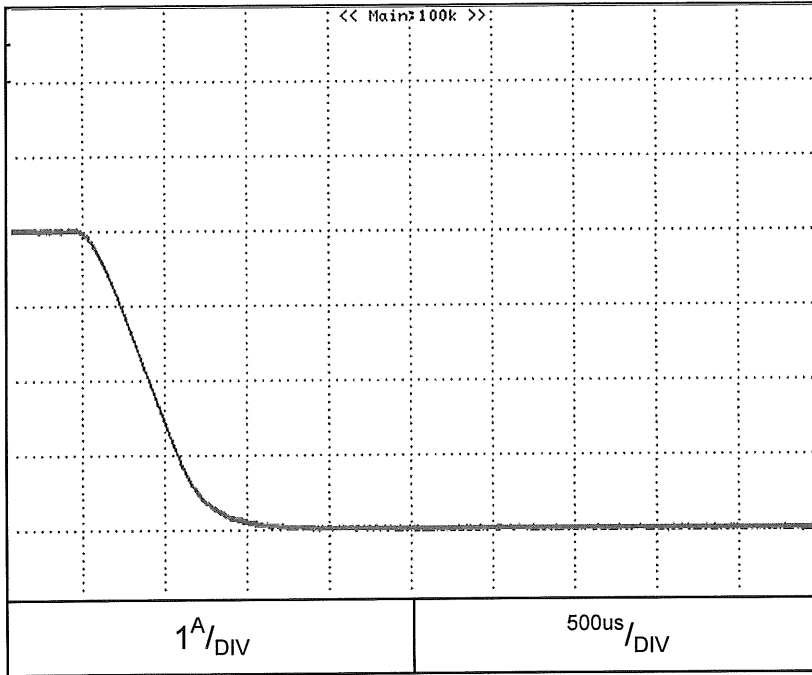

Z650-1

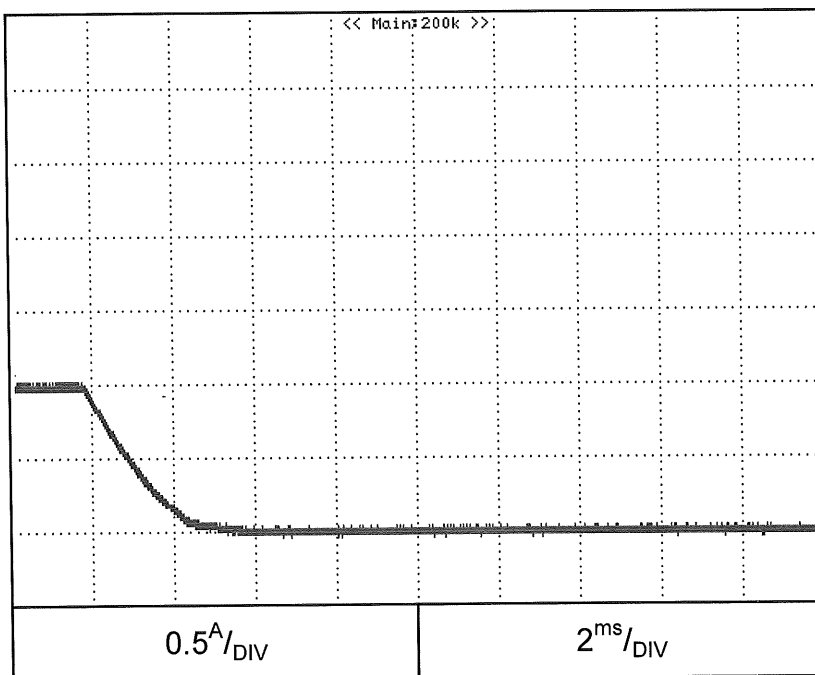

2.6 Hold up time characteristics

Conditions: Vin:100Vac
Vout: 100%
Ta = 25°C

Z160-4

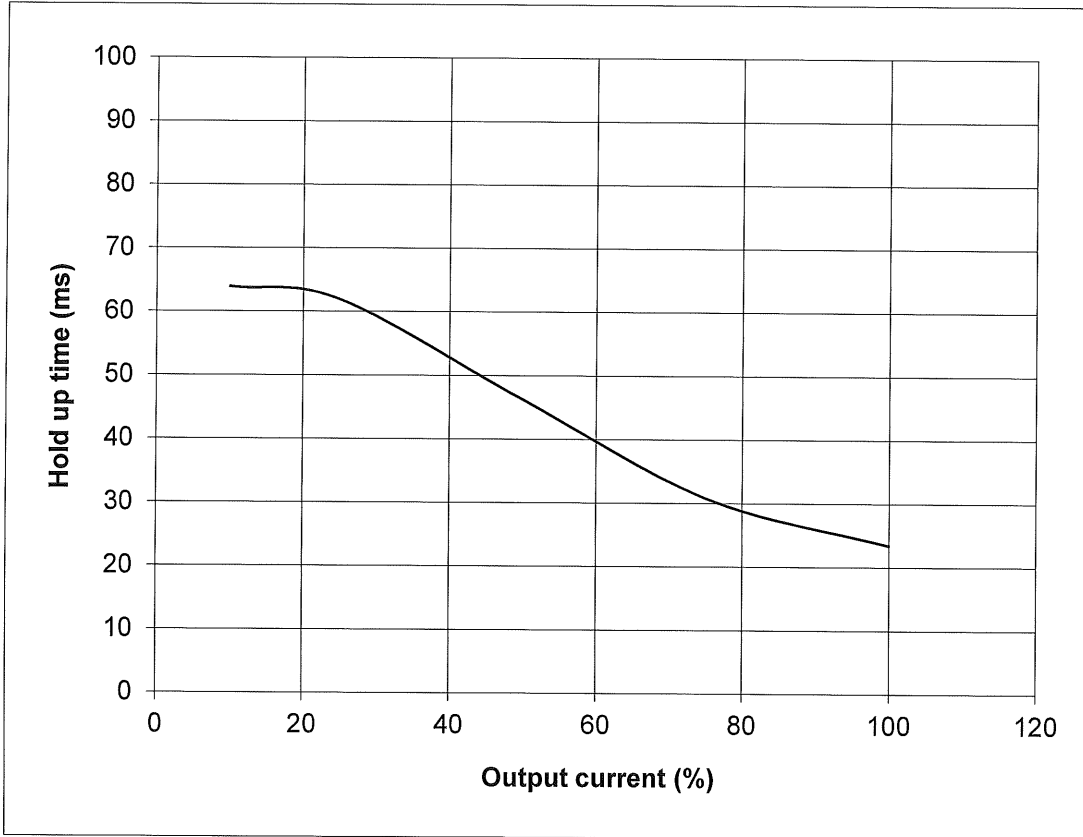

2.6 Hold up time characteristics

Conditions: Vin:100Vac
Vout: 100%
Ta = 25°C

Z650-1

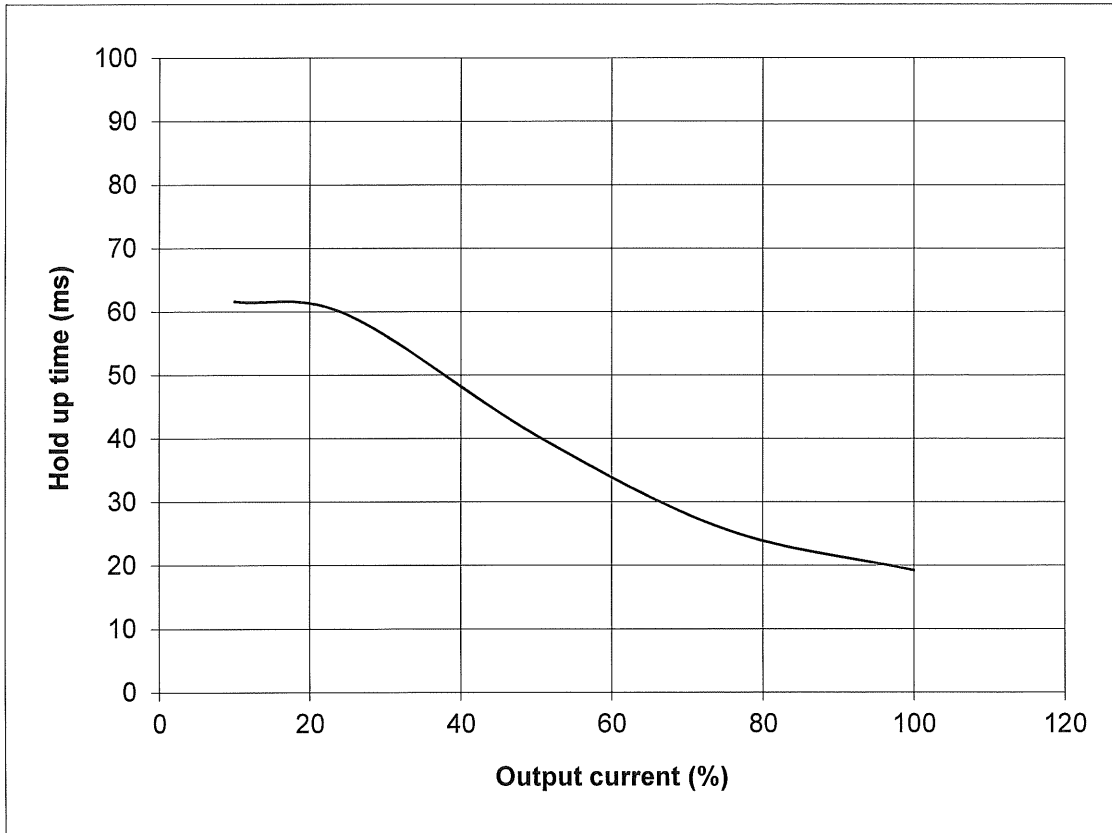

2.7 Dynamic line response characteristics

Conditions:

Vin: 85↔132V

Vout: 100%

Iout: 100%

Ta = 25°C

C.V mode

Z160-4

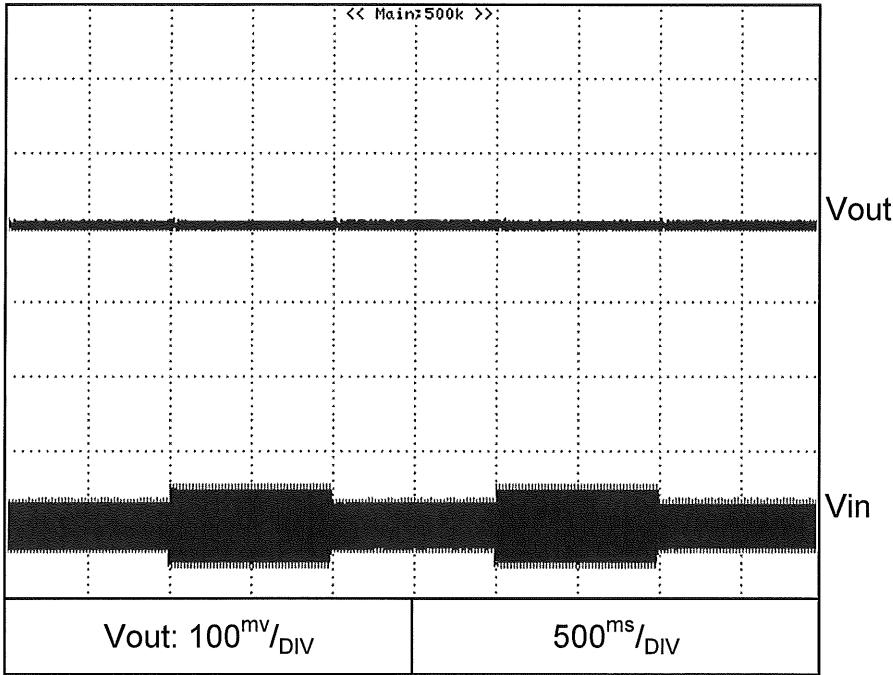

Conditions:

Vin: 170↔265V

Vout: 100%

Iout: 100%

Ta = 25°C

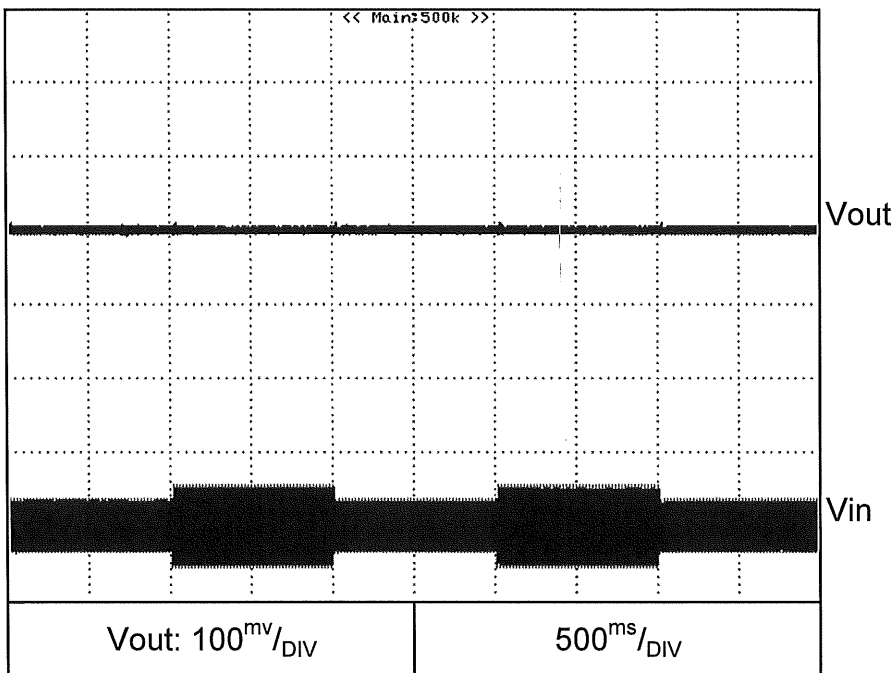

2.7 Dynamic line response characteristics

Conditions:

Vin: 85↔132V

Vout: 100%

Iout: 100%

Ta = 25°C

C.V mode

Z650-1

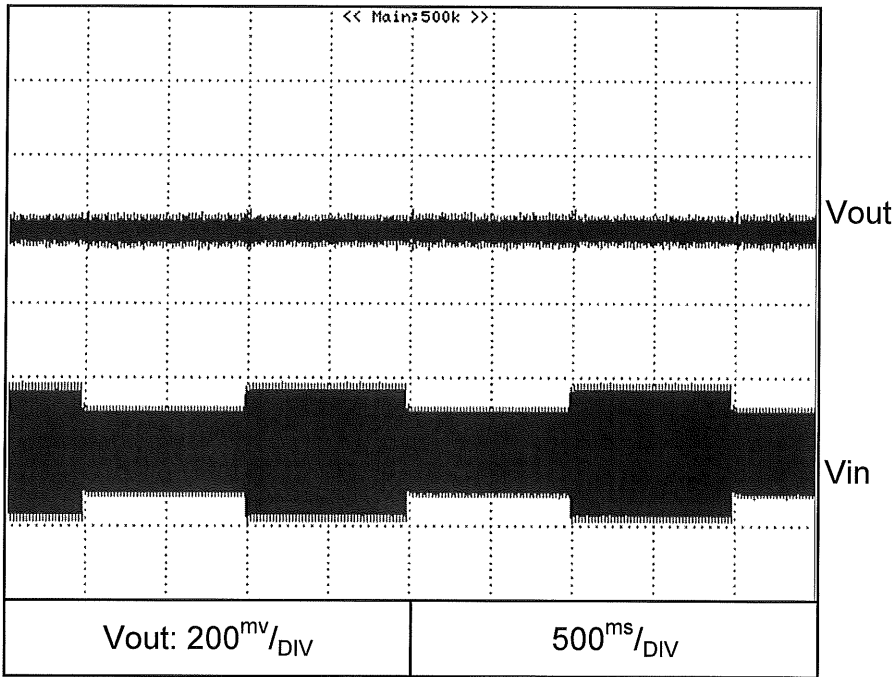

Conditions:

Vin: 170↔265V

Vout: 100%

Iout: 100%

Ta = 25°C

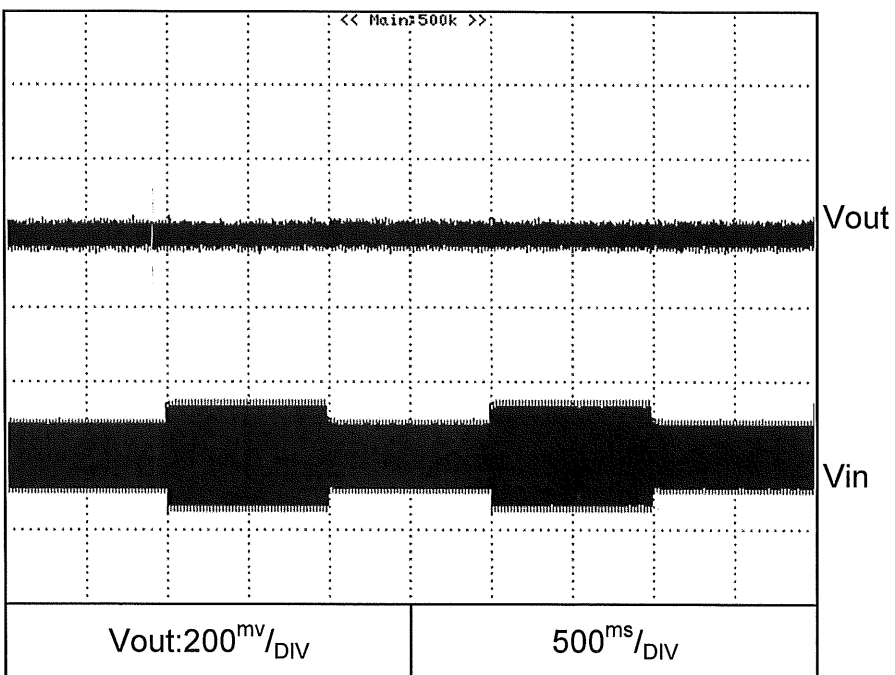

2.7 Dynamic line response characteristics

Conditions:

Vin: 85↔132V

Vout: 100%

Iout: 100%

Ta = 25°C

C.C mode

Z160-4

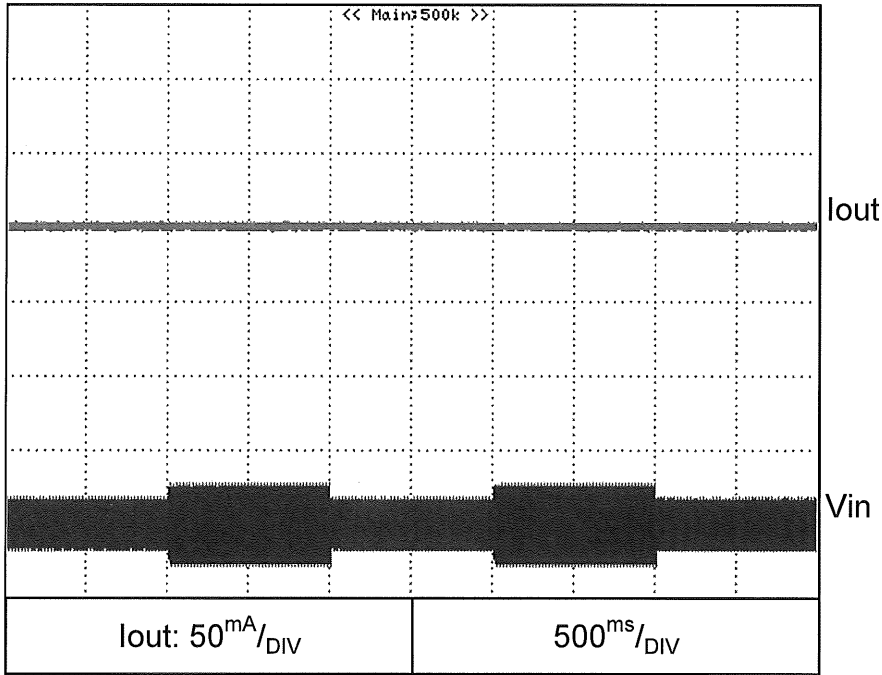

Conditions:

Vin: 170↔265V

Vout: 100%

Iout: 100%

Ta = 25°C

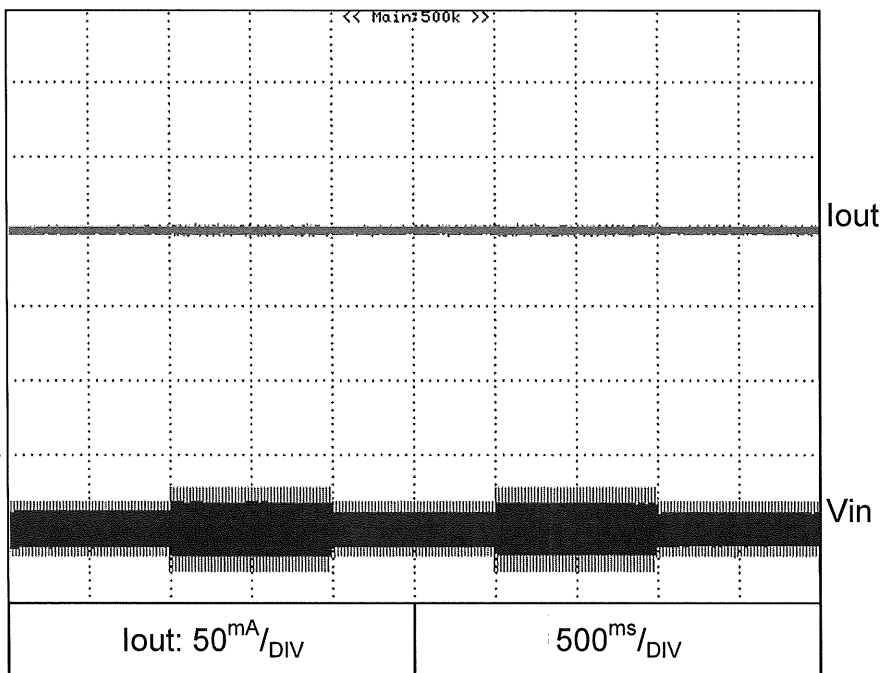

2.7 Dynamic line response characteristics

Conditions:

V_{in}: 85↔132V

V_{out}: 100%

I_{out}: 100%

T_a = 25°C

C.C mode

Z650-1

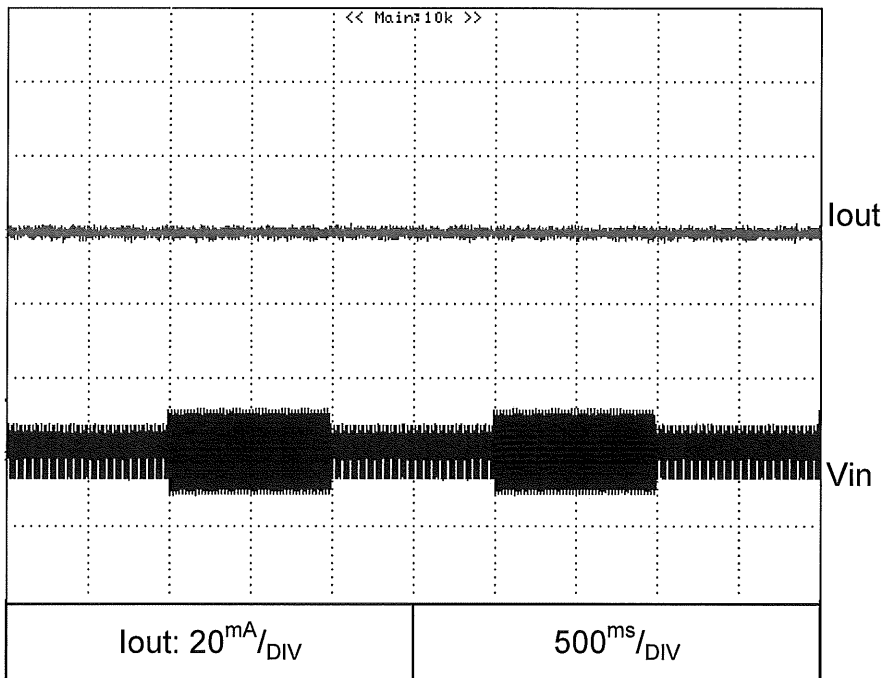

Conditions:

V_{in}: 170↔265V

V_{out}: 100%

I_{out}: 100%

T_a = 25°C

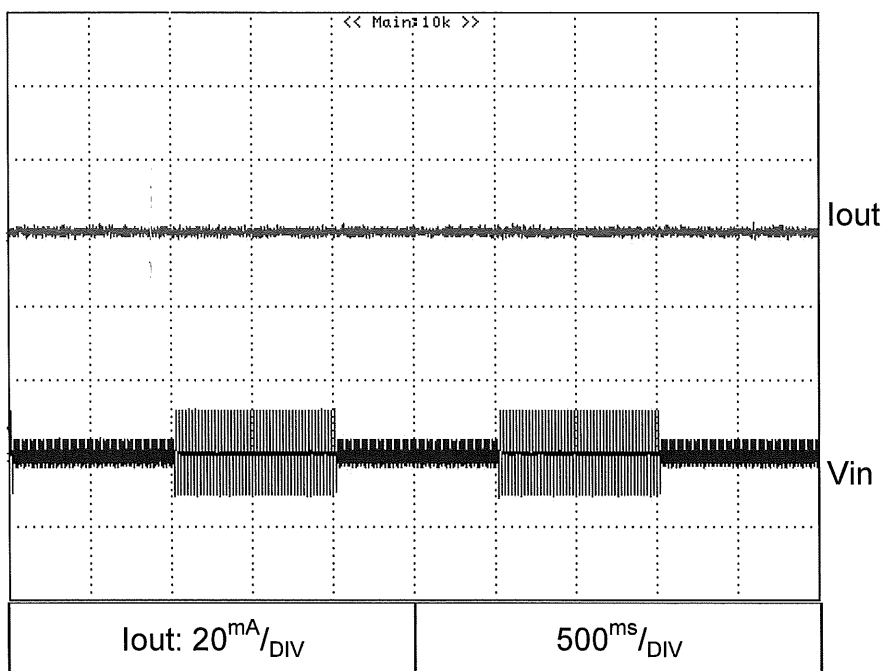

2.8 Dynamic load response characteristics

C.V mode

Conditions: Vin:100Vac
Vout: 100%
Ta = 25°C

Load current: tr=tf=100us

Z160-4

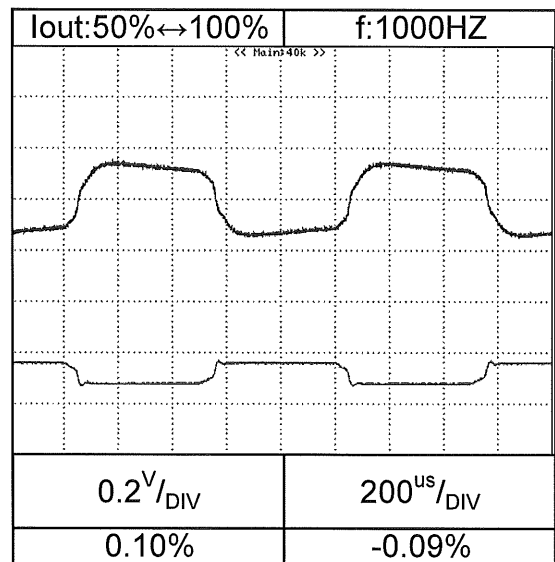
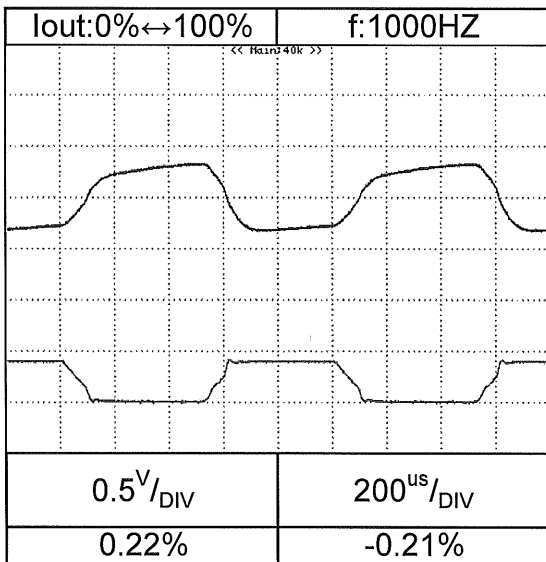
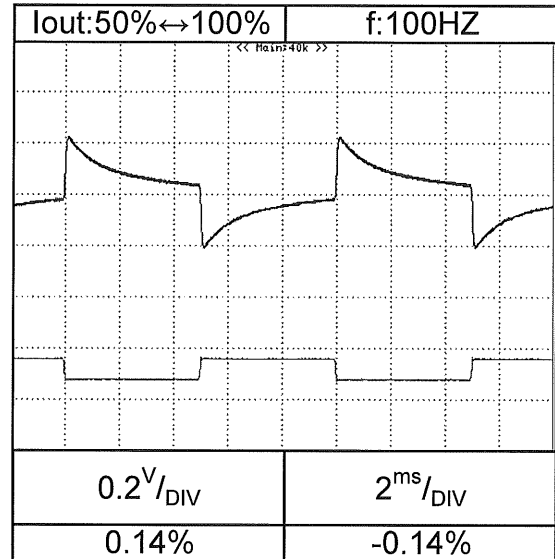
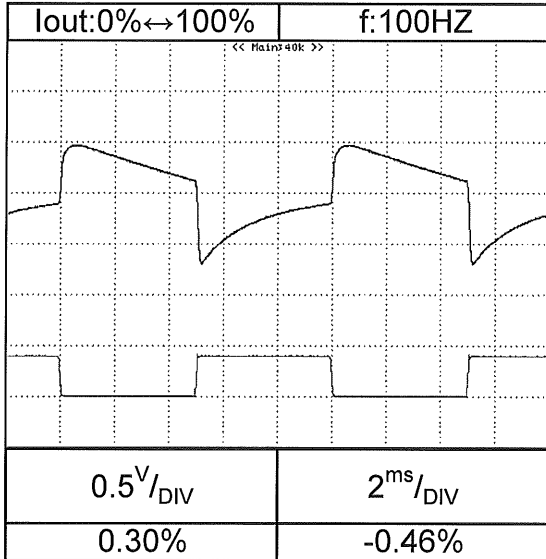

2.8 Dynamic load response characteristics

C.V mode

Conditions: Vin:100Vac
Vout: 100%
Ta = 25°C

Load current: tr=tf=100us

Z650-1

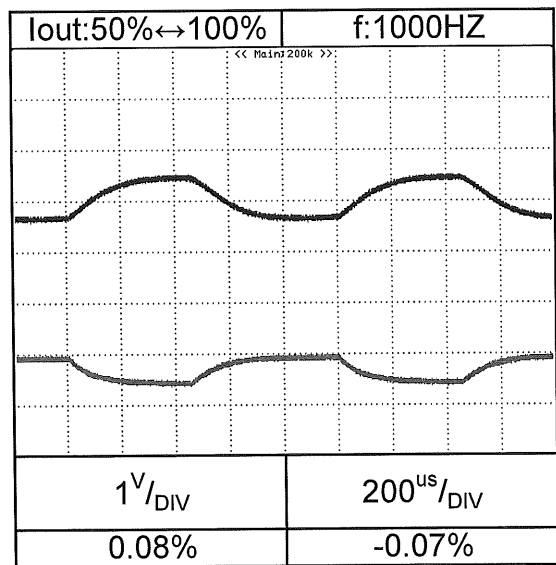
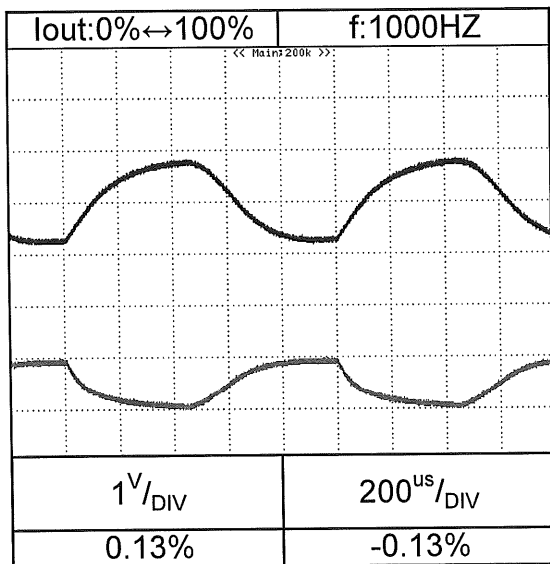
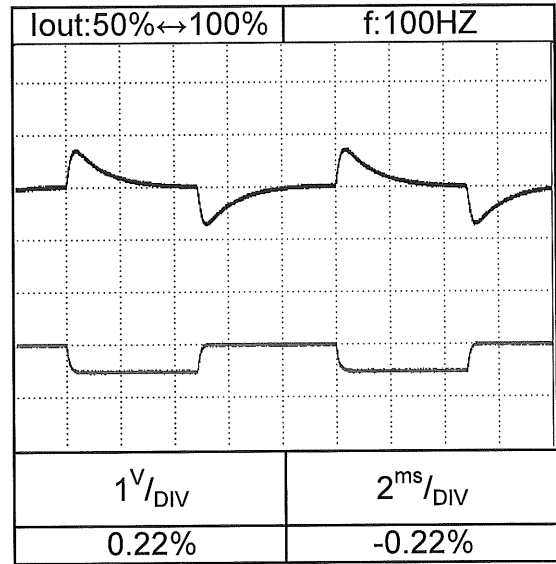
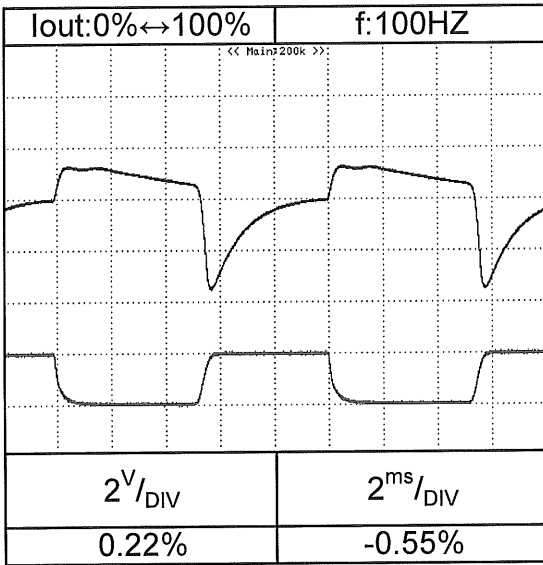

2.8 Dynamic load response characteristics

Conditions: Vin:100Vac
Ta = 25°C

C.C mode

Z160-4

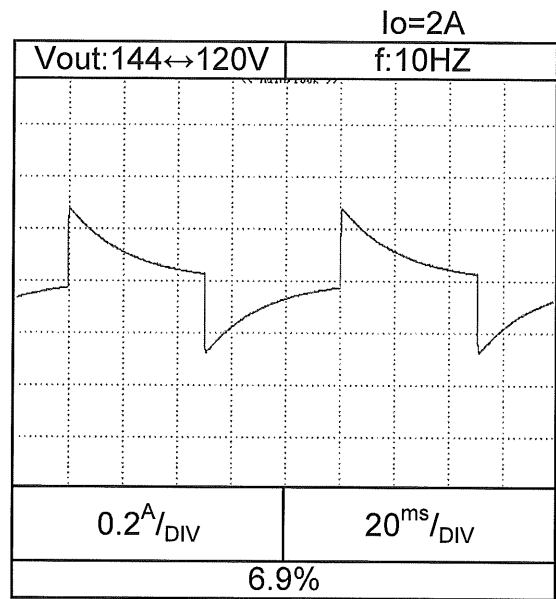
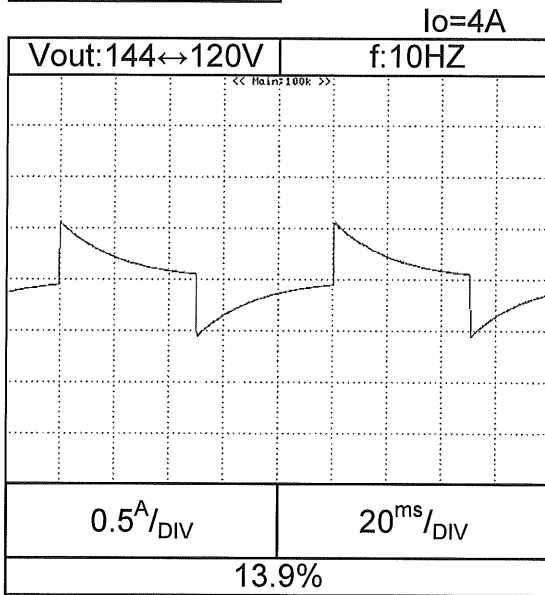

Z650-1

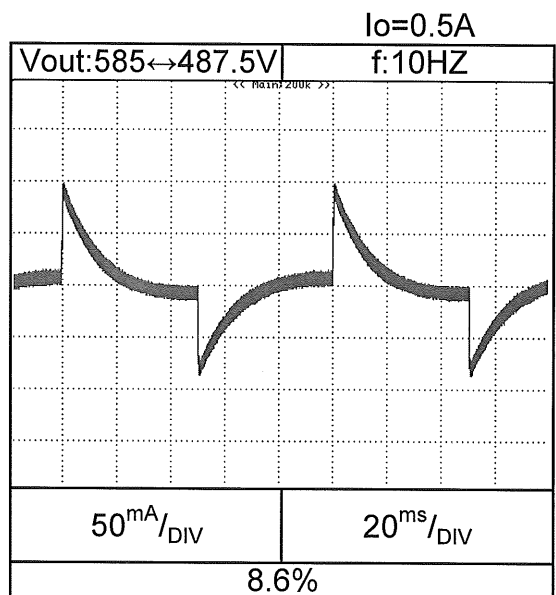
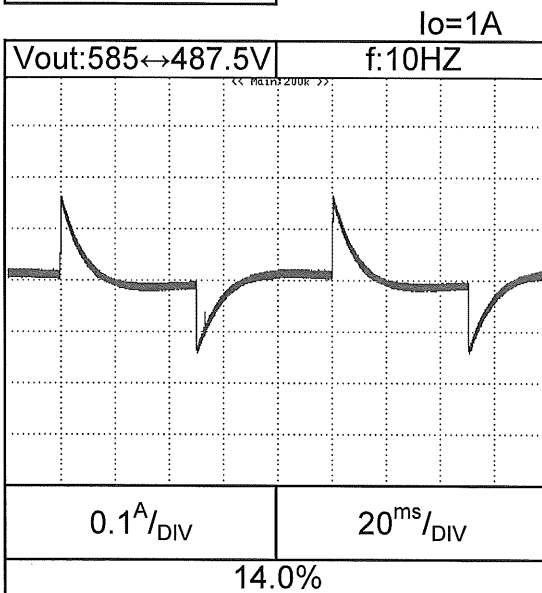

2.9 Response to brown-out characteristics

Conditions:

V_{in}: 100VAC

V_{out}: 100%

I_{out}: 100%

T_a = 25°C

C.V mode

Z160-4

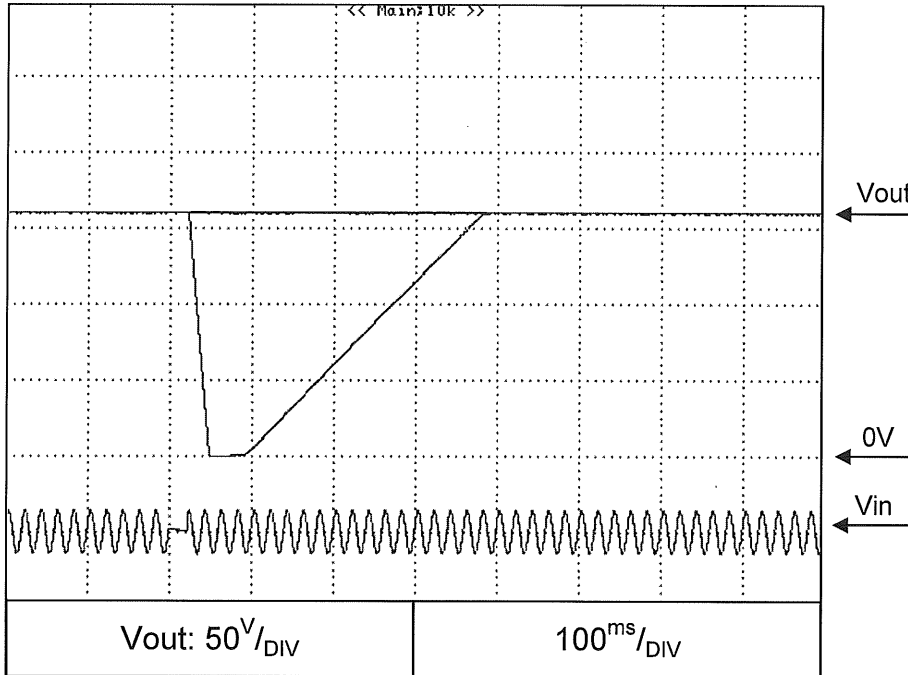

Brown-out time

A - 22mS

C - 23mS

2.9 Response to brown-out characteristics

Conditions:

Vin: 100VAC

Vout: 100%

Iout: 100%

Ta = 25°C

C.V mode

Z650-1

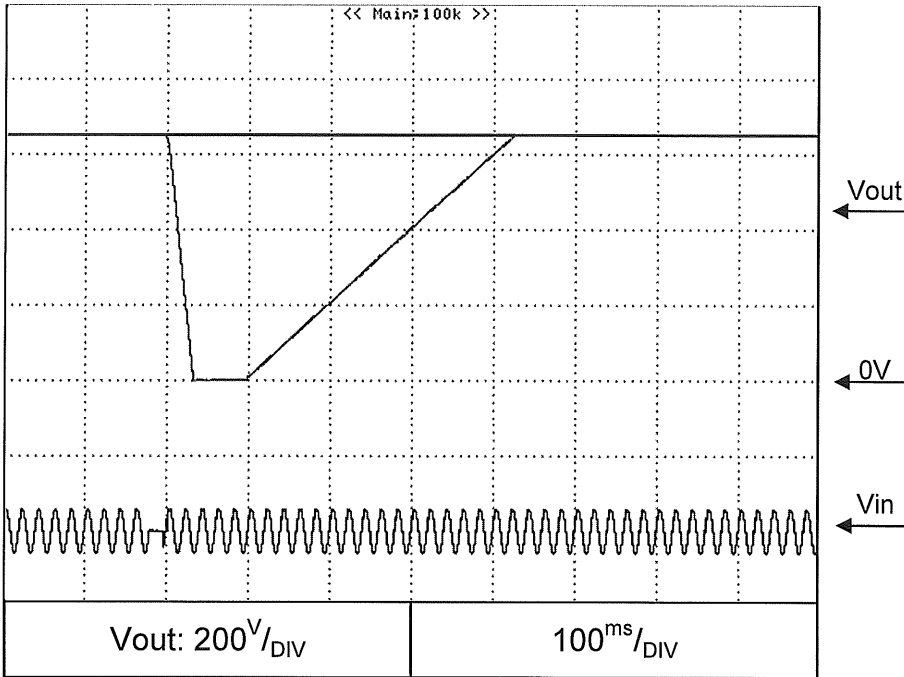

Brown-out time

A - 19ms

C - 23ms

2.9 Response to brown-out characteristics

Conditions:

V_{in}: 100VAC

V_{out}: 100%

I_{out}: 100%

T_a = 25°C

C.C mode

Z160-4

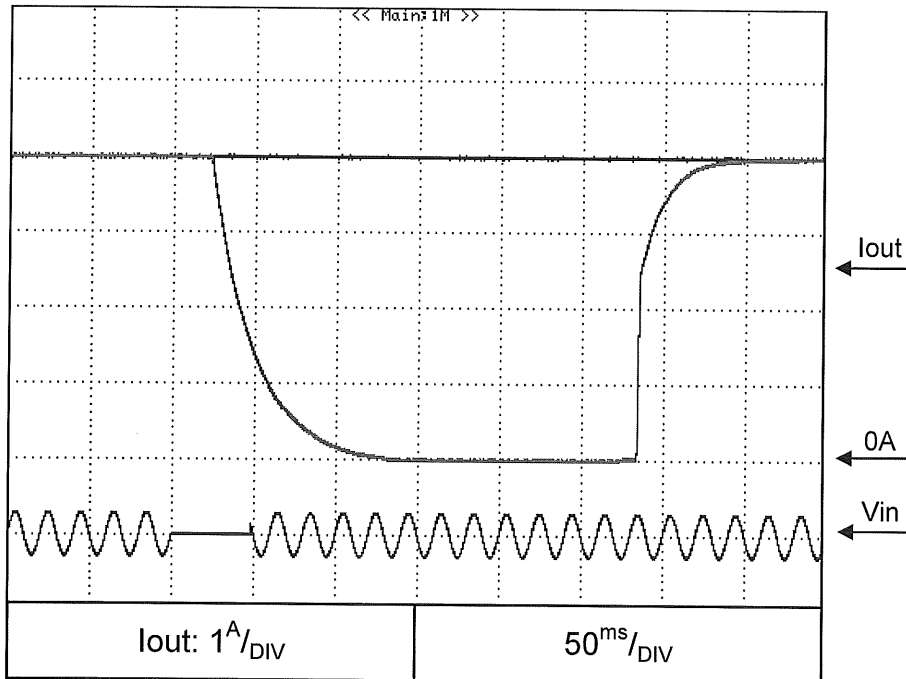

Brown-out time

A - 23mS

C - 48mS

2.9 Response to brown-out characteristics

Conditions:

V_{in}: 100VAC

V_{out}: 100%

I_{out}: 100%

T_a = 25°C

C.C mode

Z650-1

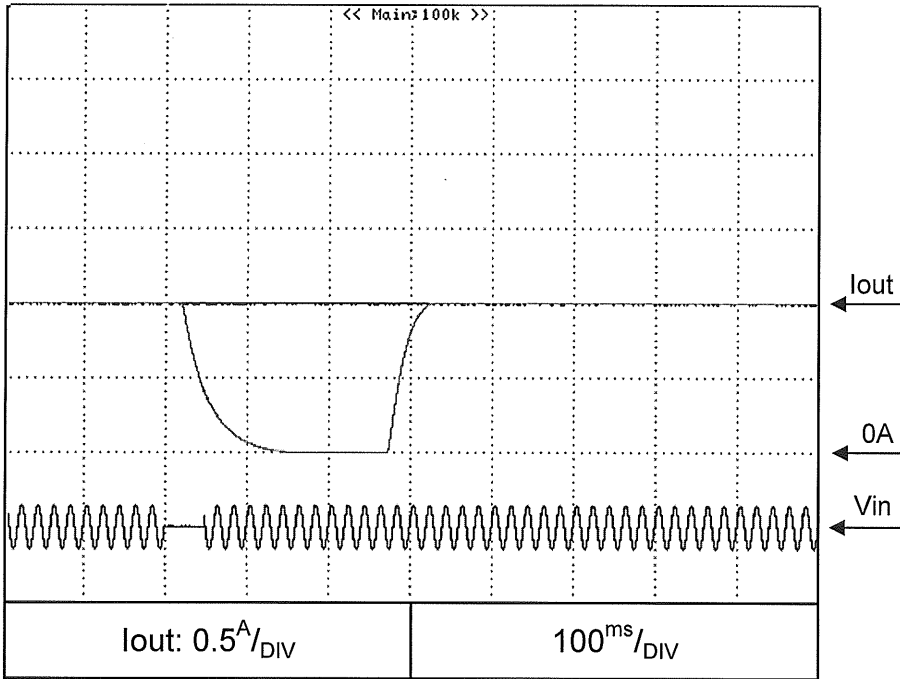

Brown-out time

A - 19mS

C - 48mS

2.10 Inrush Current Characteristics during line brown outs

Conditions: Vin: 100VAC
Vout: 100%
Iout: 0%
Iout: 100%
Ta = 25°C

—————

Z650-1

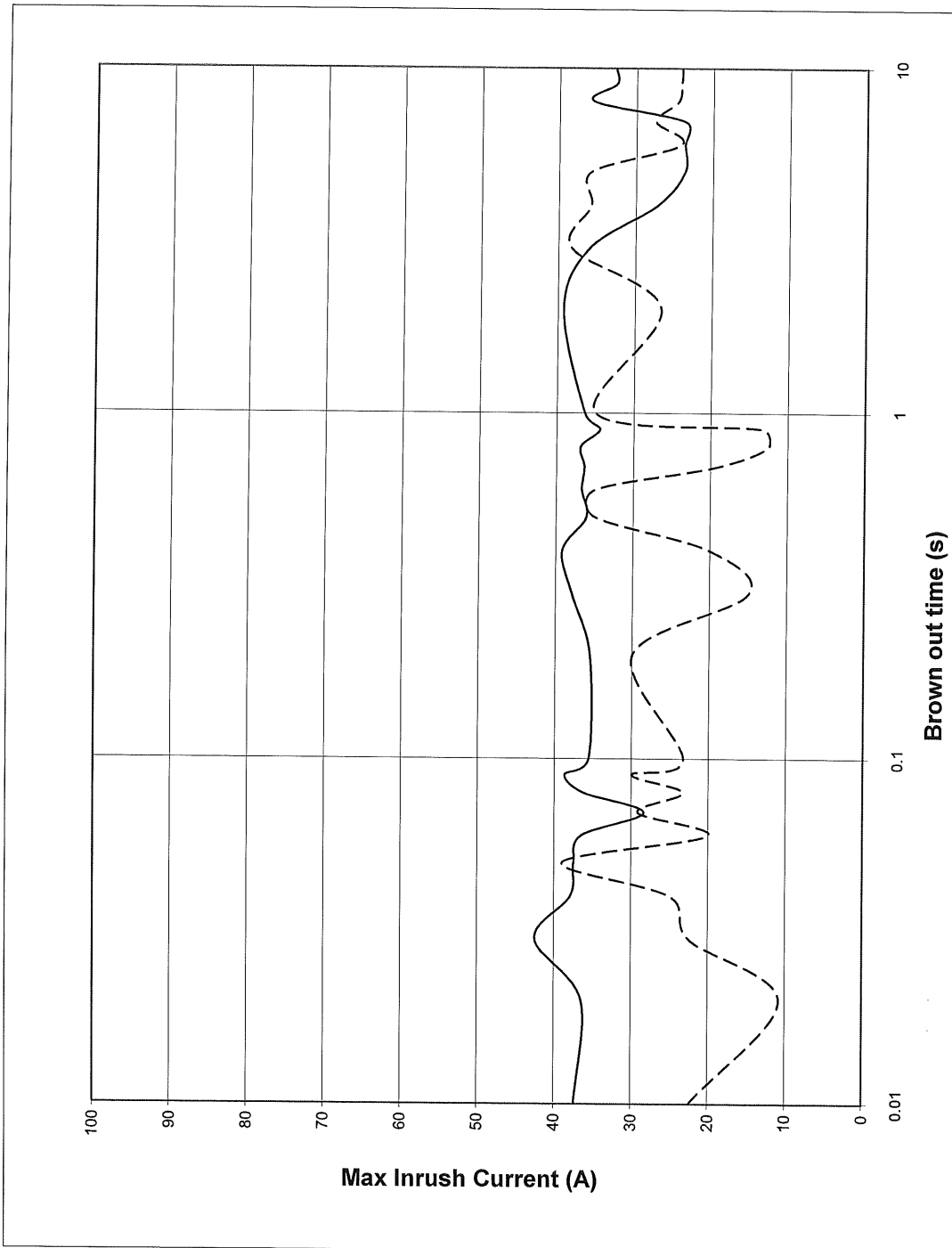

2.10 Inrush Current Characteristics during line brown outs

Conditions: Vin: 200VAC
Vout: 100%
Iout: 0% -----
Iout: 100% -----
Ta = 25°C

Z650-1

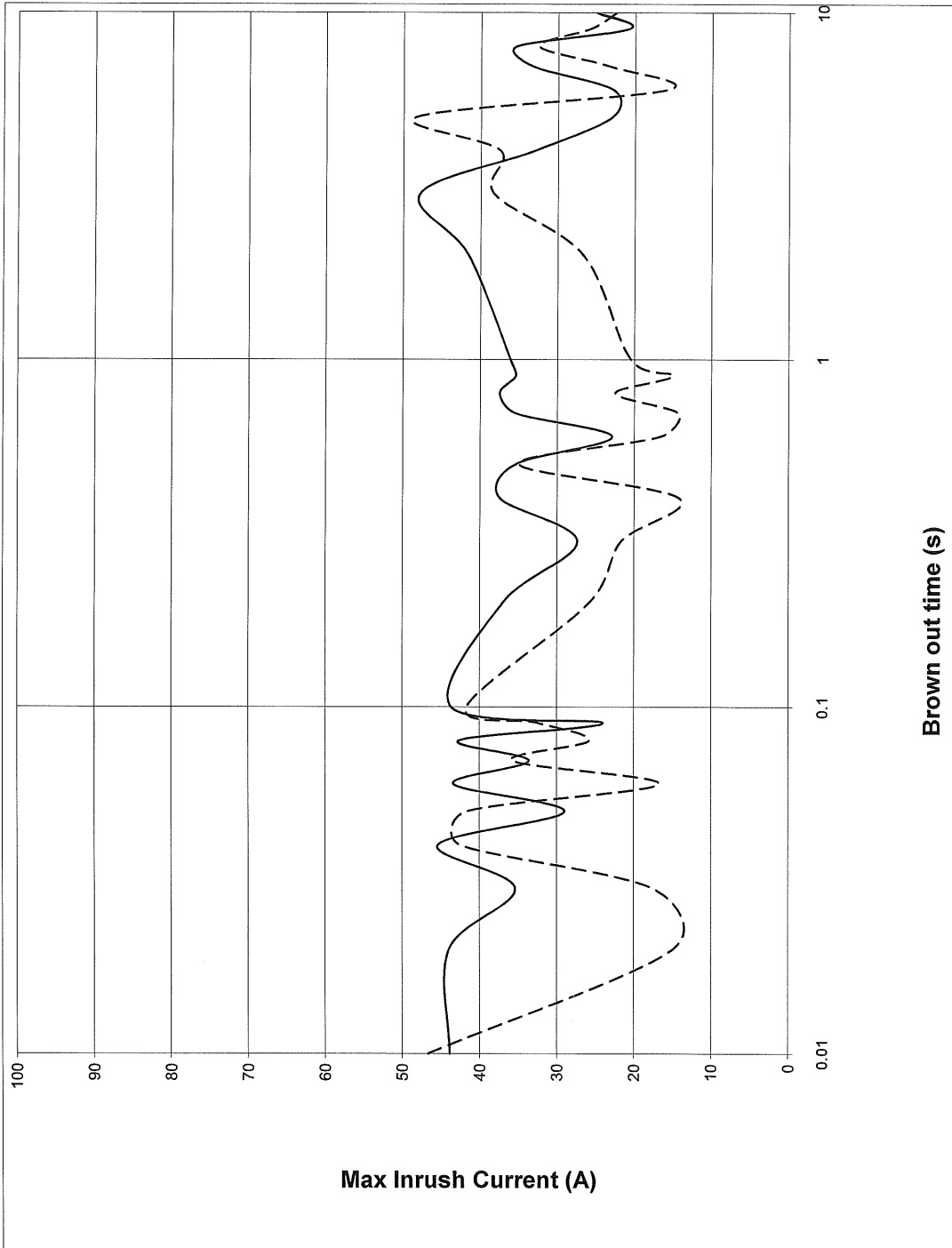

2.11 Inrush current waveform

Conditions: Vin: 100V
Vout: 100%
Iout: 100%
Ta = 25°C

Z650-1

Switch on phase angle
of input AC voltage

$\phi=0^\circ$

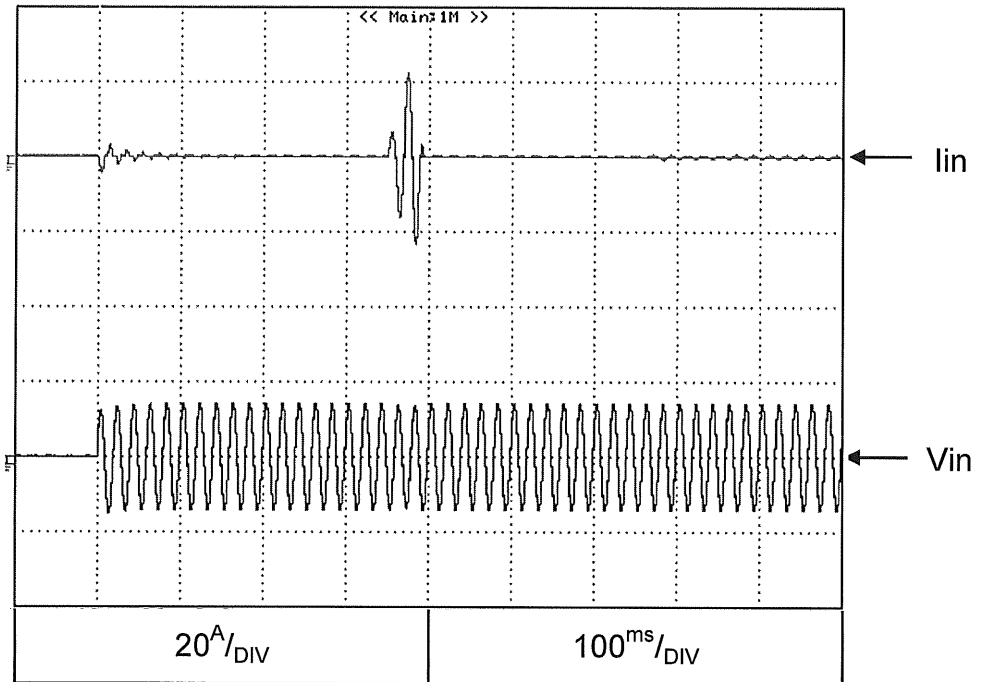

Switch on phase angle
of input AC voltage

$\phi=90^\circ$

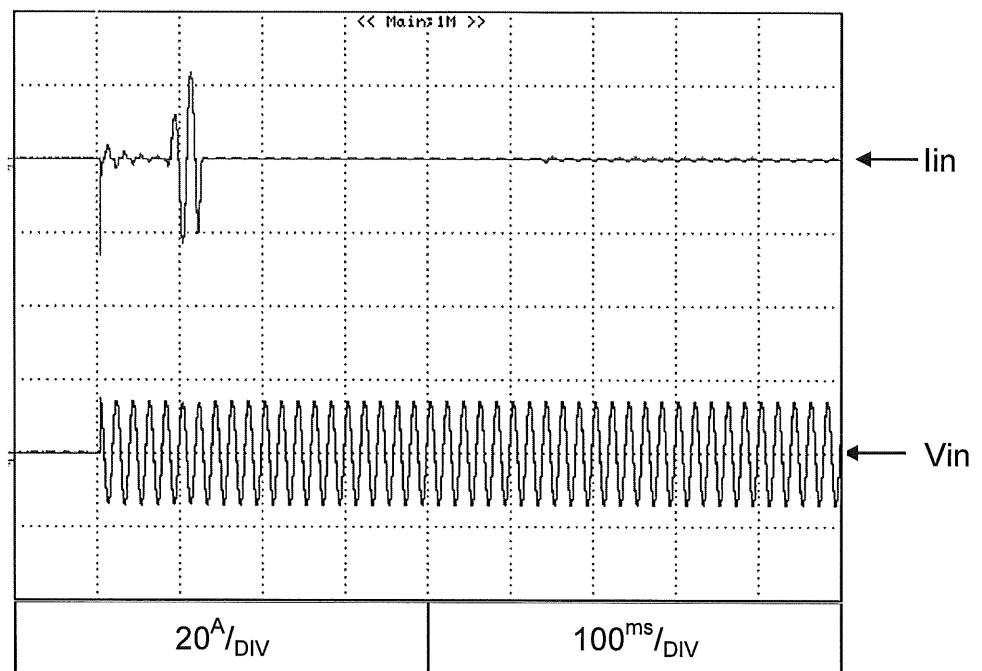

2.11 Inrush current waveform

Conditions: Vin: 200V
Vout: 100%
Iout: 100%
Ta = 25°C

Z650-1

Switch on phase angle
of input AC voltage

$\Phi=0^\circ$

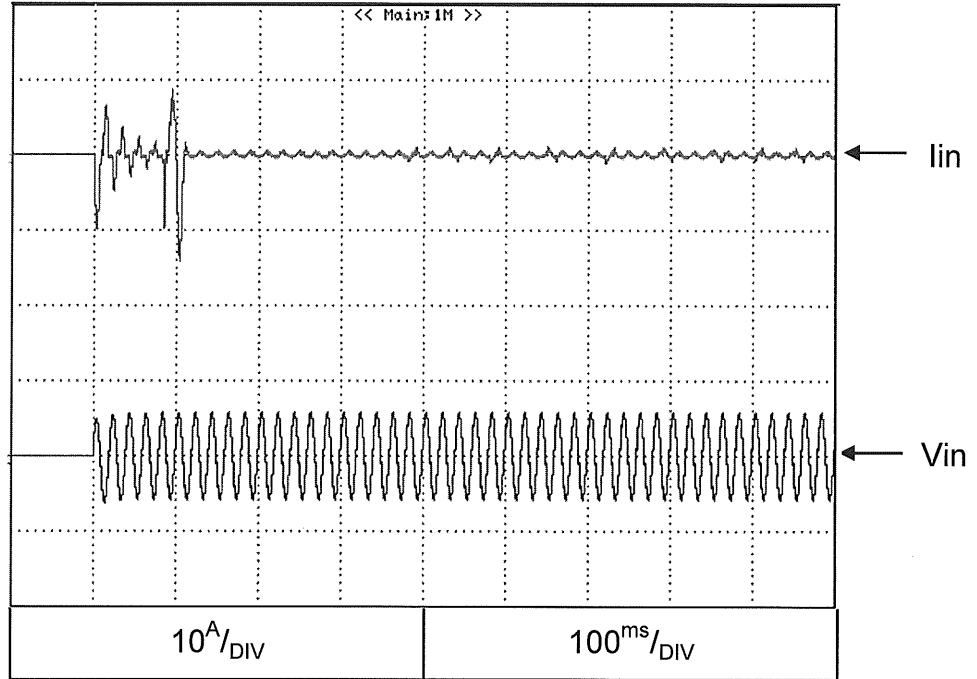

Switch on phase angle
of input AC voltage

$\Phi=90^\circ$

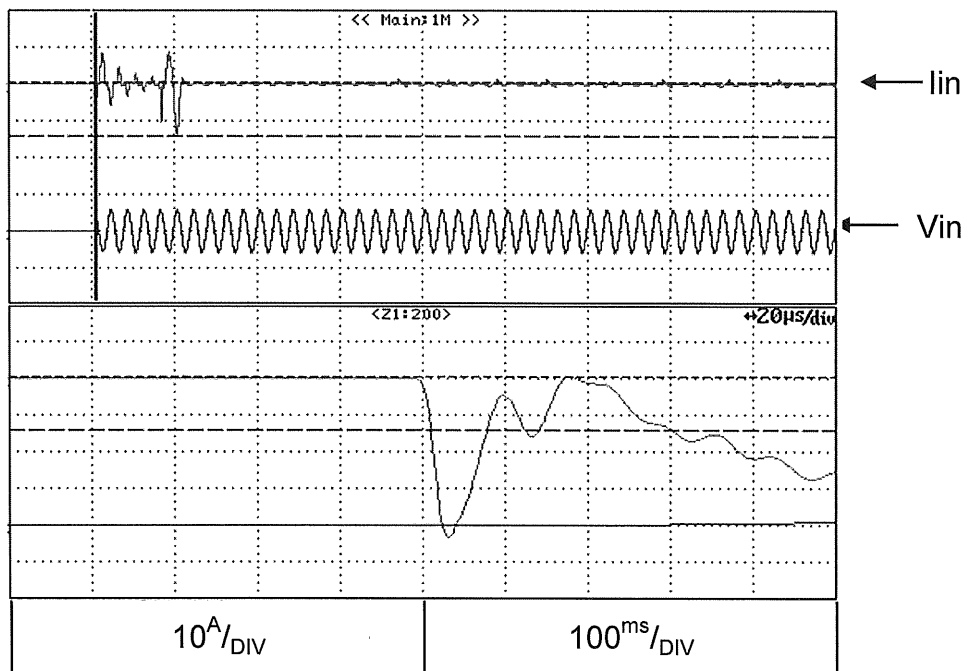

2.12 Input current waveform

Conditions: Vin: 100VAC
Vout: 100%
Iout: 100%
Ta = 25°C

Z650-1

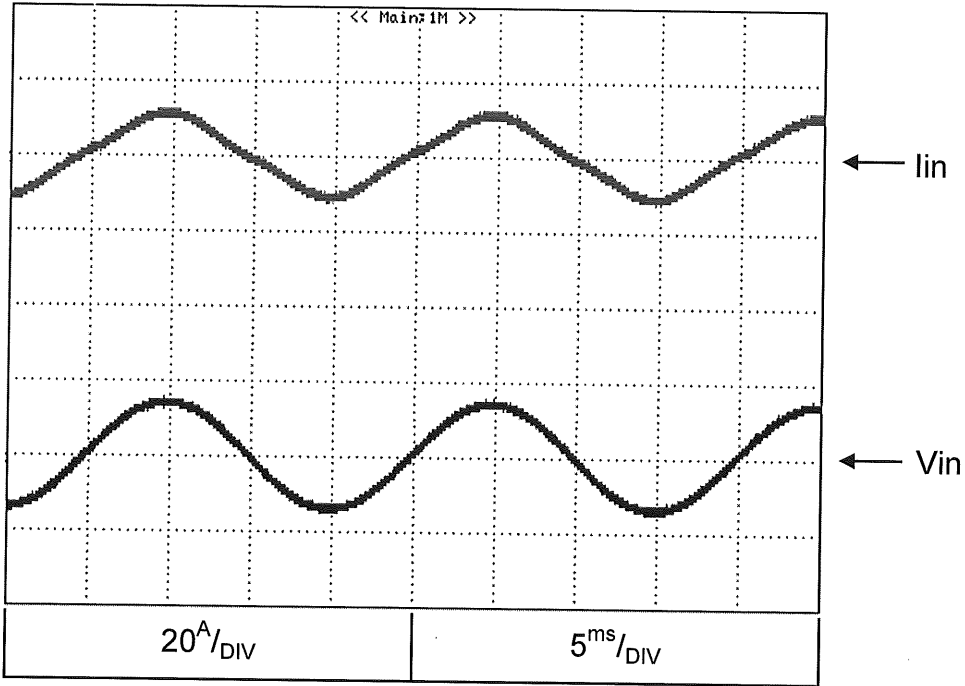

Conditions: Vin: 200VAC
Vout: 100%
Iout: 100%
Ta = 25°C

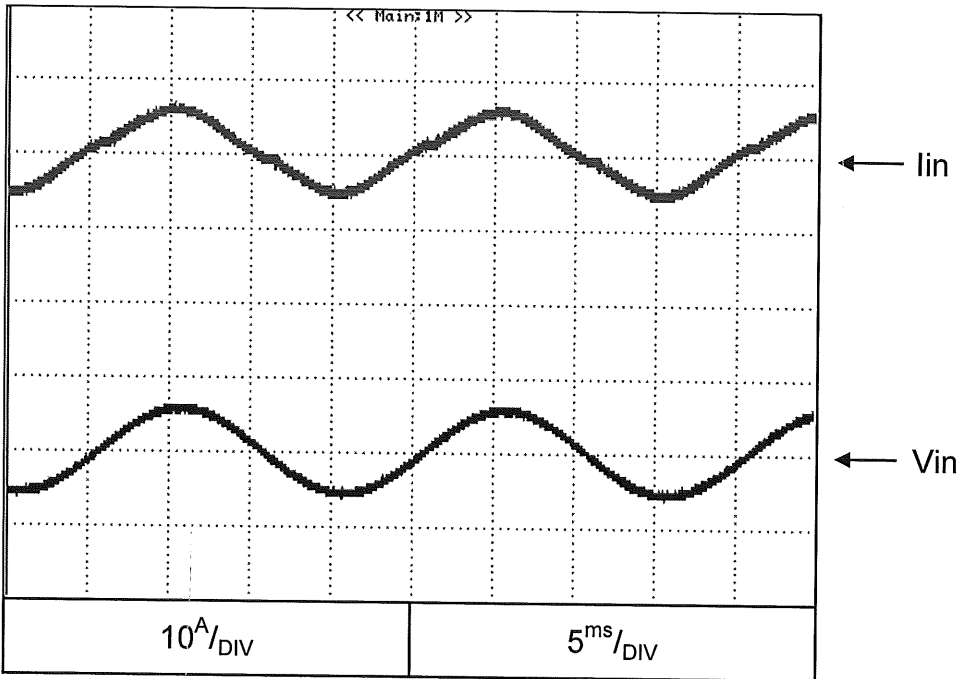

2.13 Leakage current characteristics

Conditions: Vin: 100~265Vac

Iout: 0% - - - - -

Iout: 100% —————

Ta = 25°C

f=50HZ

Z650-1

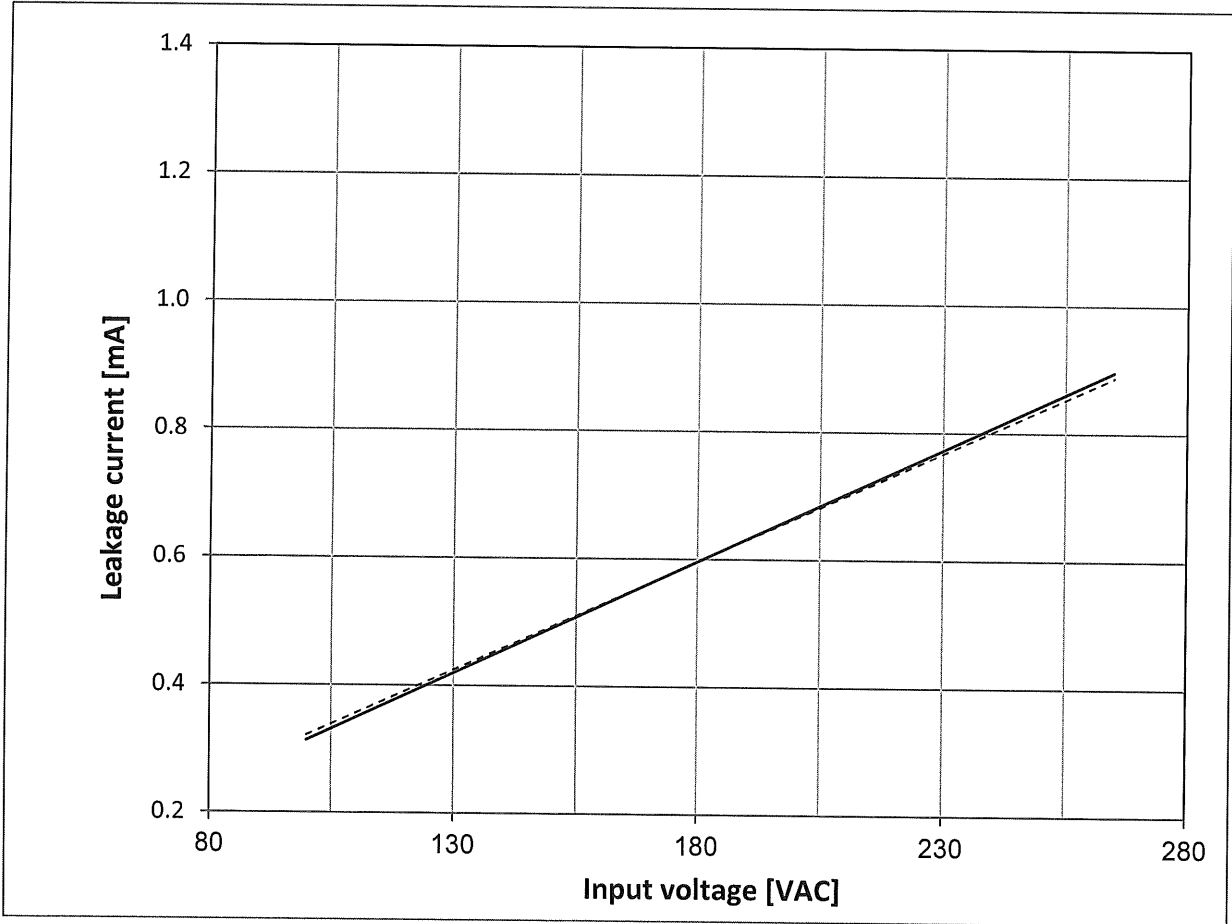

2.14 Output voltage ripple & noise waveform

Conditions: Vin: 100VAC

C.V mode

Vout: 100%

Iout: 100%

Ta = 25°C

Normal Mode

Z160-4

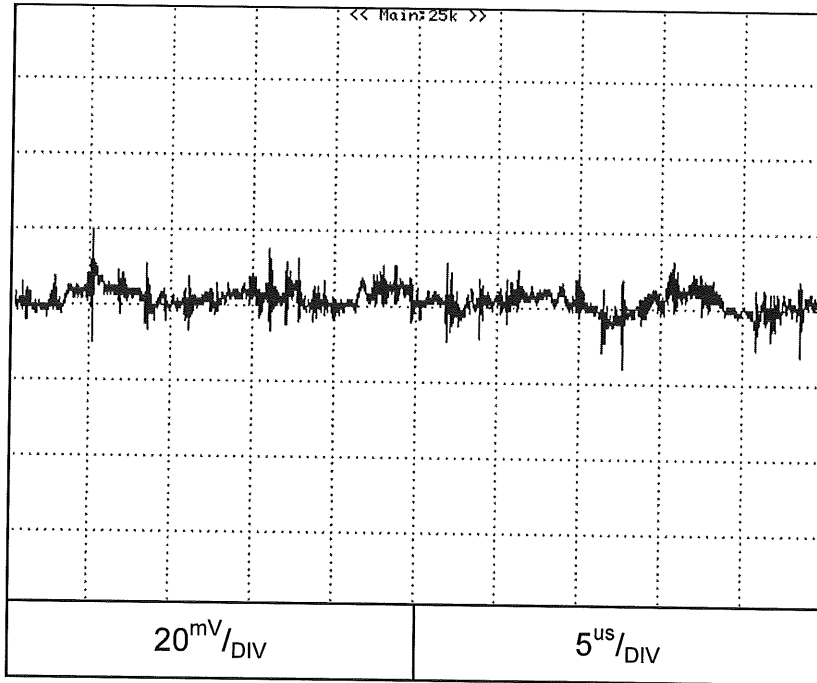

Z650-1

