

PY-Family Heatsink Selection Guide

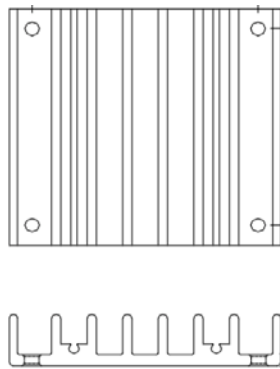

Content:

- 1. Product Description.....2
- 2. Overview of Heatsink Kits.....2
- 3. Installation Instruction.....2
- 4. Heatsink Selection.....2
- 5. Physical Dimensions3

Heatsinks for DC-DC Converters of the PY Family

1. PRODUCT DESCRIPTION

These heatsink kits are suitable for use with DC-DC converters of the PY-family. They are available as accessories in various sizes.

All heatsink kits include the heatsink, thermal pad and the required mounting material.

2. OVERVIEW OF HEATSINK KITS

| Part number | Converter footprint | Length x width w/o clips) | Height | Weight | Finstyle | Thermal impedance |
|----------------------|---------------------|-----------------------------|------------------|--------|--------------|-------------------|
| ACC-PYQB-HC01 | Quarter-brick | 58 x 36.8mm 2.28 x 1.49" | 21mm / 0.83" | xx g | Transverse | 4.8°C/W |
| ACC-PYQB-HC05 | Quarter-brick | 36.8 x 58mm 1.49 x 2.28" | 12.7mm / 0.5" | xx g | Longitudinal | 5.6°C/W |
| ACC-PYHB-HC01 | Half-brick | 61 x 58mm 2.4 x 2.28" | 25.4mm / 1.0" | xx g | Transverse | 3.0°C/W |
| ACC-PYHB-HC02 | Half-brick | 61 x 58mm 2.4 x 2.28" | 12.7mm / 0.5" | xx g | Transverse | 4.7°C/W |
| ACC-PYHB-HC05 | Half-brick | 58 x 60.7mm 2.28 x 2.39" | 21mm / 0.83" | xx g | Longitudinal | 3.9°C/W |

All heatsink kits include one heatsink, one thermal pad and mounting material.

3. INSTALLATION INSTRUCTION

The recommended tightening torque for DC-DC converters with thread inserts is 3kgf-cm (0.3Nm).

4. HEATSINK SELECTION

| Part number | PYQ50 | PYQ75 | PYH200 |
|----------------------|-------|-------|--------|
| ACC-PYQB-HC01 | X | X | |
| ACC-PYQB-HC05 | X | X | |
| ACC-PYHB-HC01 | | | X |
| ACC-PYHB-HC02 | | | X |
| ACC-PYHB-HC05 | | | X |

5. PHYSICAL DIMENSIONS

ACC-PYQB-HC01,
ACC-PYQB-HC05

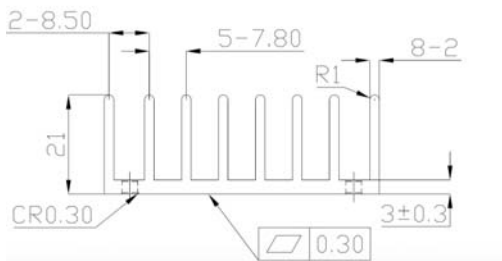
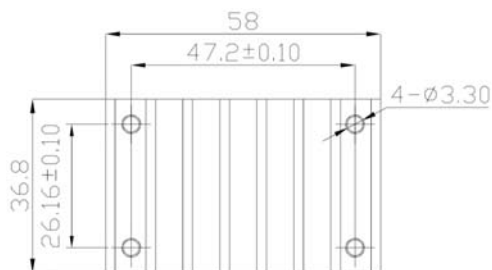
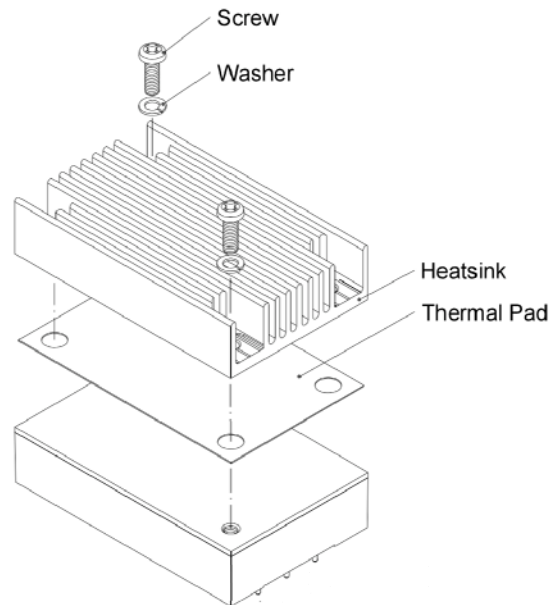

ACC-PYQB-HC01

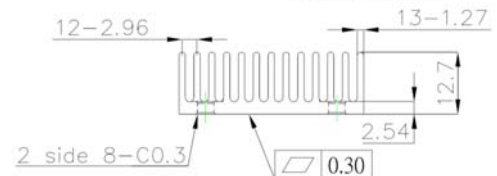
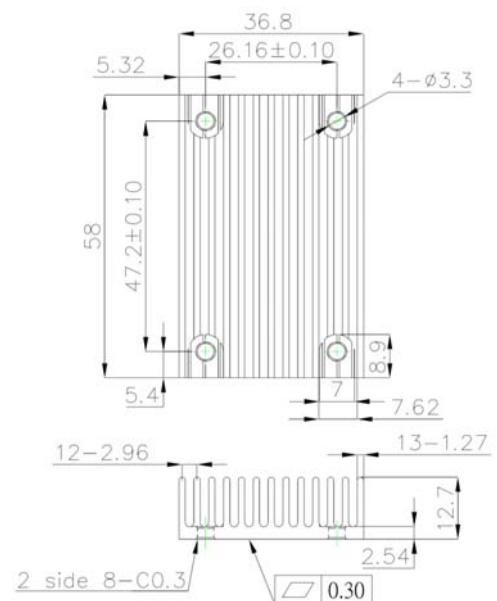

ACC-PYQB-HC05

Heatsinks for DC-DC Converters of the PY Family

ACC-PYHB-HC01,
ACC-PYHB-HC02,
ACC-PYHB-HC05

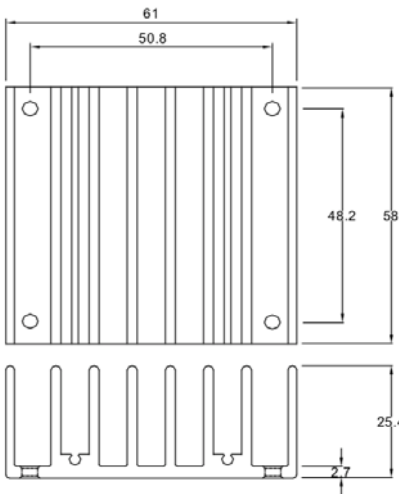
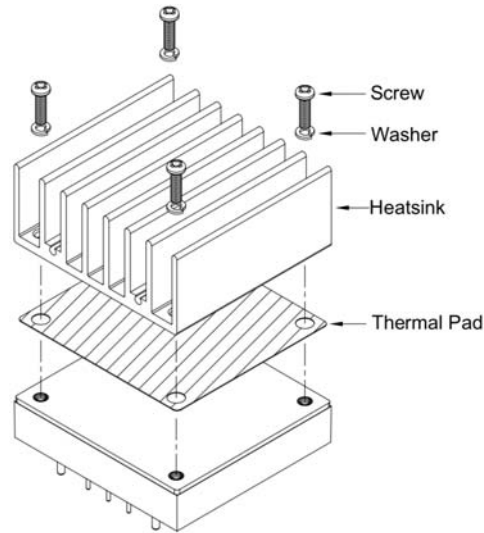

ACC-PYHB-HC01

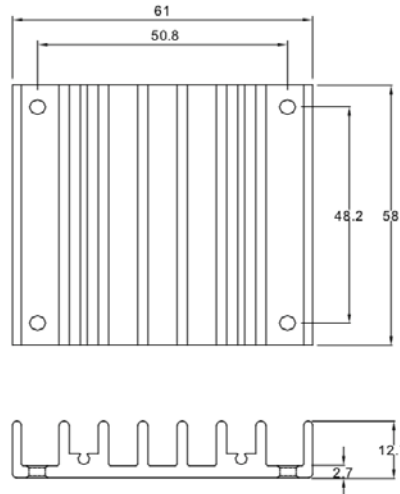

ACC-PYHB-HC02

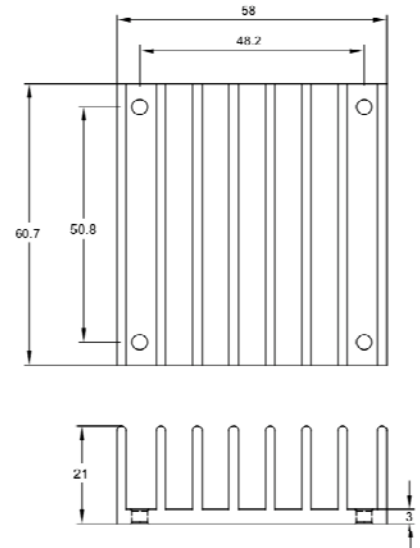

ACC-PYHB-HC05